

NRA presentation

C-1 Authorization process

Regulatory process under the Reactor Regulation Act

OTSUJI YAMAMOTO Ayako
Nuclear Regulation Authority JAPAN

IAEA Regulatory Review Mission on ALPS Treated Water Handling
23 March 2022



Contents

1. Regulatory process for ALPS treated water discharge
2. Regulatory requirements for TEPCO Fukushima Daiichi
3. Review based on the regulatory requirements
 - 3-1. Measures to be taken with regard to the overall process and risk assessment
 - 3-2. Treatment, storage, and management of radioactive liquid waste
 - 3-3. Radiation protection in the area surrounding the site by restricting release of radioactive materials
 - 3-4. Design considerations
 - 3-5. Measures taken for operational safety of the Specified Nuclear Facility
 - 3-6. Safety assessment of facility design upon unusual occurrences
4. Pre-service inspection



1. Regulatory process for ALPS treated water discharge



1. Regulatory process for ALPS treated water discharge

NRA

Review of IP

NRA Review Meetings (11 meetings so far) we are now here.

Draft review result to be reported and discussed by the NRA Commission

Receiving public comments

Results of public comment to be reported to the NRA Commission

Decision on approval by the NRA Commission

Approval of IP

Start of Operational Safety Inspection (cont.)

NRA's Preservice Inspection on SSCs

Pass of NRA's Preservice Inspection

Operational Safety Inspection continues

Periodic Facility Inspection

TEPCO

Application of Implementation Plan (IP)

Submission of revised IP

Start of SSCs Installation

Tests on SSCs

Completion of Installation

Start of operation(cont.)



1. Regulatory process for ALPS treated water discharge

- On 21st December in 2021, TEPCO submitted to the NRA the “Application Documents for Approval to ***Amend the Implementation Plan*** for Fukushima Daiichi Nuclear Power Station Specified Nuclear Facility” regarding the handling of ALPS treated water.

Contents of Application Document

- Design of the following major equipment
 - ❑ Measurement/confirmation facility
 - ❑ Transfer facility
 - ❑ Dilution facility
 - ❑ Discharge facility
- Operational safety measures for discharge
- Measures to achieve the statements in the government basic policy, including as reference document ***the Radiological Impact Assessment Report Regarding the Discharge of ALPS Treated Water into the Sea (design stage)***



1. Regulatory process for ALPS treated water discharge

- The NRA started its Review Meeting to have discussions with TEPCO and to see:
 - ✓ *Whether the TEPCO's Implementation Plan conforms to the regulatory requirements* (“Items required for Measures which should be taken at Tokyo Electric Power Co., Inc.’s Fukushima Daiichi Nuclear Power Station in line with the Designation as the Specified Nuclear Facility”); and
 - ✓ *Whether the TEPCO's Implementation Plan is in line with the government basic policy.*
- The NRA has held 11 Review Meetings so far, approximately once a week, and plans to hold a few more meetings as necessary to prepare its review conclusion.
- Review Meeting is open to the public to attend for listening at the NRA meeting room as well as through web-streaming, and its materials are posted on the NRA website.



1. Regulatory process for ALPS treated water discharge

Topics discussed in each Review Meeting

Review Meeting*	Date	Topics
3 rd	24 th December 2021	<ul style="list-style-type: none">● Overview of application
4 th	11 th January 2022	<ul style="list-style-type: none">● Meaning of discharge in the overall programme for decommissioning● Safety assessment of facility design upon abnormal occurrences ①
5 th	20 th January 2022	<ul style="list-style-type: none">● Mix and dilution rate of ALPS treated water into seawater● Homogeneity of radioactivity concentration in tanks①● Effective dose assessment on site boundaries● Annual discharge amount of tritium
6 th	27 th January 2022	<ul style="list-style-type: none">● Structure and strength of components, design consideration for natural phenomena including earthquake, and reliability ①● Radiological impact assessment on surrounding environment
7 th	1 st February 2022	<ul style="list-style-type: none">● Detection of abnormality and suspend of discharge● Structure and strength of components, design consideration for natural phenomena including earthquake, and reliability ②● Safety assessment of facility design upon abnormal occurrences ②● Measures to be taken in response to the result of sea area monitoring

*The first 2 Review Meetings were held for the other applications regarding the organizational structure to implement discharge and to install additional tasks to substitute for K-4 tanks which will be converted to the sampling tasks.



1. Regulatory process for ALPS treated water discharge

Topics discussed in each Review Meeting

Review Meeting*	Date	Topics
8 th	7 th February 2022	<ul style="list-style-type: none">● Analysis method of radioactivity concentration in ALPS treated water, and the operational structure and human resources for analysis①● Method of intake seawater and discharge of diluted water①● Structure and strength of components, design consideration for natural phenomena including earthquake, and reliability ③
9 th	15 th February 2022	<ul style="list-style-type: none">● Analysis method of radioactivity concentration in ALPS treated water, and the operational structure and human resources for analysis②● Method of intake seawater and discharge of diluted water②● Structure and strength of components, design consideration for natural phenomena including earthquake, and reliability④
10 th	25 th February 2022	<ul style="list-style-type: none">● Homogeneity of radioactivity concentration in tanks② (Result of circulation test)● Responses to the comments made by the NRA
11 th 12 th 13 th	1 st March 10 th March 18 th March	<ul style="list-style-type: none">● Responses to the comments made by the NRA



1. Regulatory process for ALPS treated water discharge

Reference documents for IAEA regulatory review

- *Regulations relevant to TEPCO Fukushima-Daiichi NPS*

No.	Titles
1	Act on the Regulation of Nuclear Source Material, Nuclear Fuel Material and Reactors
2	Cabinet Order on Special Provisions of the Act on the Regulation of Nuclear Source Material, Nuclear Fuel Material and Reactors about the Nuclear Reactors at TEPCO's Fukushima Daiichi NPS
3	NRA Ordinance for Operational Safety and Protection of Specified Nuclear Fuel Materials of the Nuclear Reactors at TEPCO's Fukushima Daiichi
4	Notification to Establish Requirements for Operational Safety and Physical Protection of Specified Nuclear Fuel Materials of the Nuclear Reactors at TEPCO's Fukushima Daiichi NPS
5	Notification to Establish Dose Limits in Accordance with the Provisions of the NRA Ordinance on Activities of Refining Nuclear Source or Nuclear Fuel Materials, etc.
6	Items required for Measures which should be taken at Tokyo Electric Power Co., Inc.'s Fukushima Daiichi Nuclear Power Station in line with the Designation as the Specified Nuclear Facility

- *Documents of Review Meetings prepared by the NRA*

*preparing translation of documents after 5th meeting

Meeting No.	3 rd	4 th	5 th	6 th	7 th	8 th	9 th	10 th	11 th	12 th	13 th
Meeting documents*	○	-	-	-	-	-	-	-	-	-	○
minutes	○	○	○	○	○	○	○	○	○	○	○

- *Draft structure of the NRA's review result (to be prepared by the Secretariat and discussed by NRA Commission)*

- *NRA's Self-evaluation to the IAEA's Safety Standards*

- *NRA's presentation materials at the Regulatory Mission*



2. Regulatory requirements for TEPCO Fukushima Daiichi



2. Regulatory requirements for TEPCO Fukushima Daiichi

Regulatory requirements “Items required for Measures which should be taken at Tokyo Electric Power Co., Inc.’s Fukushima Daiichi Nuclear Power Station in line with the Designation as the Specified Nuclear Facility”

- Decided by the NRA Commission in Nov 2012 upon designation of Fukushima Daiichi as Specified Nuclear Facility
- Tailormade regulation for Fukushima Daiichi after the accident



Mainly relevant to
ALPS treated water
discharge

The contents of the regulatory requirements:

- I. Measures to be Taken with regard to the Overall Process and Risk Assessment
- II. Items concerning Measures to be taken for Design and Equipment
- III. Items concerning Measures Taken for Operational Safety of the Specified Nuclear Facility
- IV. Items concerning Measures to be Taken for Physical Protection of Specified Nuclear Fuel Materials
- V. Items concerning Measures to be Taken for Retrieval of Fuel Debris and Reactor Decommissioning
- VI. Items to be Taken into Consideration in Developing the Implementation Plan
- VII. Promotion of Understanding of the Implementation Plan
- VIII. Inspections to be Undergone Pertaining to the Implementation Plan



2. Regulatory requirements for TEPCO Fukushima Daiichi

The contents of the regulatory requirements:

- I. Measures to be Taken with regard to the Overall Process and Risk Assessment
- II. Items concerning Measures to be taken for Design and Equipment
- III. Items concerning Measures Taken for Operational Safety of the Specified Nuclear Facility

Occupational Radiation Protection

is covered by the presentation C-4.

- Source term characterization is covered by the presentation C-3.
- Source monitoring is covered by the presentation D.

Mainly relevant to
ALPS treated water
discharge



2. Regulatory requirements for TEPCO Fukushima Daiichi

The Principle of the regulatory requirements - Excerpt from the introduction-

With the objective of reducing and optimizing risks of the overall the Specified Nuclear Facility, for example, completing fuel removal, etc. as early as possible and thus ensuring on-site and off-site safety, NRA decides following items as measures to be taken by the specified licensee, TEPCO, in terms of (1) taking necessary measures promptly and efficiently to achieve the aforementioned objective; (2) for Units 1 to 4, ensuring safety of the reactor decommissioning process and completing decommissioning, including retrieval and storage of melted fuel (fuel debris), as early as possible; and (3) for Units 5 and 6, stably maintaining and continuing cold shutdown.

As for items that need progress in developing technologies in the future, such as retrieval of fuel debris, water sealing of primary containment vessels and reactor decommissioning, flexible measures such as requesting the licensee to appropriately review and revise the Implementation Plan at an appropriate time based on those status including their progress and ordering to revise the Implementation Plan from the Nuclear Regulation Authority, etc. shall be taken.

The Nuclear Regulation Authority will proactively be involved in and make recommendations to matters that need medium- to long-term approaches to ensure safety from the viewpoint of reducing and optimizing risks of the overall Specified Nuclear Facility.



3. Review based on the regulatory requirements



3. Review based on the regulatory requirements

(1) The NRA has identified the *relevant requirements for ALPS treated water discharge*:

- I. Measures to be taken with regard to the overall process and risk assessment
- II-8. Treatment, storage, and management of radioactive solid waste
- II-9. Treatment, storage, and management of radioactive liquid waste
- II-11. Radiation protection in the area surrounding the site by restricting release of radioactive materials
- II-12. Management of workers' exposure dose
- II-13. Emergency measures
- II-14. Design considerations
- III. Measures taken for operational safety of the Specified Nuclear Facility

(2) At the first review meeting, the NRA indicated *major points to be clarified by TEPCO* in accordance with the above requirements and required TEPCO to conduct safety assessment of facility design upon unusual occurrences.

(3) TEPCO provided their explanation responding to those clarifications points and received *comments from the NRA for further clarification*.

(4) Points to be further clarified

Provided to the IAEA as
reference document



3-1. Measures to be taken with regard to the overall process and risk assessment

(1) Regulatory requirement

I. Measures to be Taken with regard to the Overall Process and Risk Assessment

Overall process through completion of decommissioning including the process toward decommissioning of reactors as well as retrieval and storage of fuel debris from Units 1 to 4, and overall process for maintaining and continuing cold shutdown for Units 5 and 6 shall be respectively defined. **Overall risks of the Specified Nuclear Facility shall be reduced and optimized through assessment of each process and stage.**

In conducting risk assessment for the overall Specified Nuclear Facility and each equipment, reduction and optimization of risks shall be sufficient to ensure on-site and off-site safety through assessment including the impact on wide area of off-site environment.

(2) Major points to be clarified by TEPCO

- **Expected contribution of the Discharge Facility in reducing safety risks of the Specified Nuclear Facility as a whole**



3-1. Measures to be taken with regard to the overall process and risk assessment

(3) Comments from the NRA for further clarification

- Different aspects such as radiation protection, safety, decommissioning work and continuous improvement of site situation to be considered in the design concept
- **Consistency between the plan for the installation of new facilities required for decommissioning and the removal plan of the tanks within the whole land allocation plan**

During the review meetings, TEPCO explained:

- ALPS treated water discharge contribute to risk reduction (= progress of decommissioning, i.e., **installation of storage of fuel debris, spent fuel and solid radioactive waste**)
- The maximum amount of tritium discharge per year, **22 trillion Bq/y, dose not hamper the progress** of the decommissioning work.

(4) Points to be further clarified

- None - waiting for detailed documentation



3-2. Treatment, storage, and management of radioactive liquid waste

(1) Regulatory requirement

II-9. Treatment, storage, and management of radioactive liquid waste

In treating radioactive liquid waste such as contaminated water generated in the Facility, taking into account its characteristics, radiation dose in the area surrounding the site shall be reduced as low as reasonably achievable by controlling the waste generation, treating them appropriately to reduce concentration of radioactive materials, securing sufficient capacity for storage and providing shield, preventing leakage and expansion of contamination, etc. In addition, treatment and storage facilities shall be equipped with adequate shielding capability and structures that hamper leak of liquid waste and expansion of contamination so that radioactive materials may not be released into environment through groundwater, water leak, etc.



To be examined by the NRA under this requirement

- Homogenization of radioactivity of ALPS treated water in tanks
- Method and evaluation of mixing of ALPS treated water with seawater
- Shielding, measures for leakage prevention and expansion of contamination



3-2. Treatment, storage, and management of radioactive liquid waste

Homogenization of Radioactivity of ALPS Treated Water in Tanks Prior to Discharge into the Sea

(2) Major points to be clarified by TEPCO

- Homogenization of Radioactivity of ALPS Treated Water in Tanks Prior to Discharge into the Sea - **Method**

(3) Comments from the NRA for further clarification

- **Whether precipitated radioactive material is present** in ALPS treated water; in that case the effects of the water remaining in the tanks after discharge

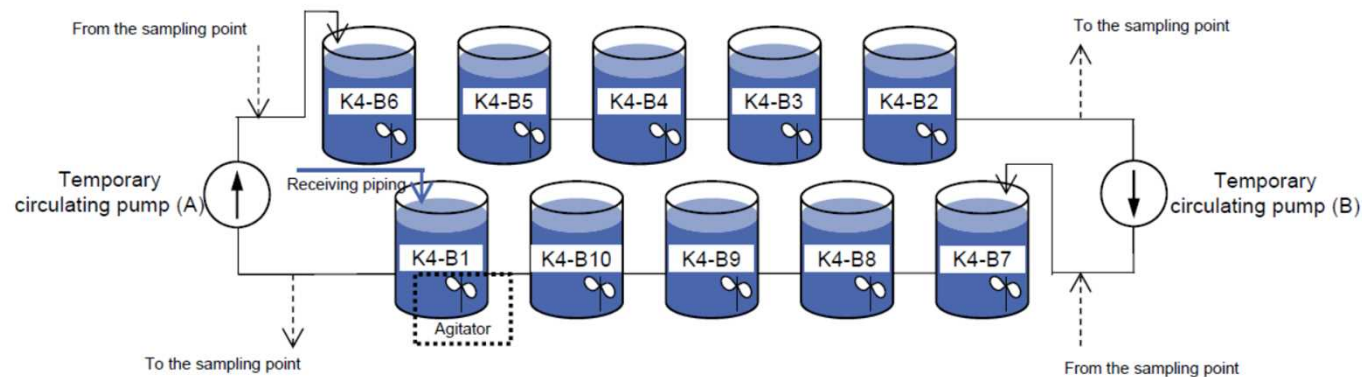

Circulation and agitation test was performed for 144 hours on 7-13 Feb 2022 .

Agitation demonstration testing: Performed in November 2021
Circulation and agitation demonstration testing: Scheduled in February 2022



3-2. Treatment, storage, and management of radioactive liquid waste

Homogenization of Radioactivity of ALPS Treated Water in Tanks Prior to Discharge into the Sea

During the review meetings, TEPCO explained:

- With tritium concentration analyzed after circulation and agitation test, **homogenization was confirmed.**
- **The other nuclides contained in ALPS treated water are in ionized state**, thus they move in the same manner as tritium.

(4) Points to be further clarified

- None - waiting for detailed documentation



3-2. Treatment, storage, and management of radioactive liquid waste

Method and evaluation of mixing of ALPS treated water with seawater

(2) Major points to be clarified by TEPCO

- Methodology of mixing with seawater to fulfill the regulatory requirement i.e., the effective dose, and the Government Basic Policy i.e., the concentration and the amount of tritium

Key point 1: Flowmeter

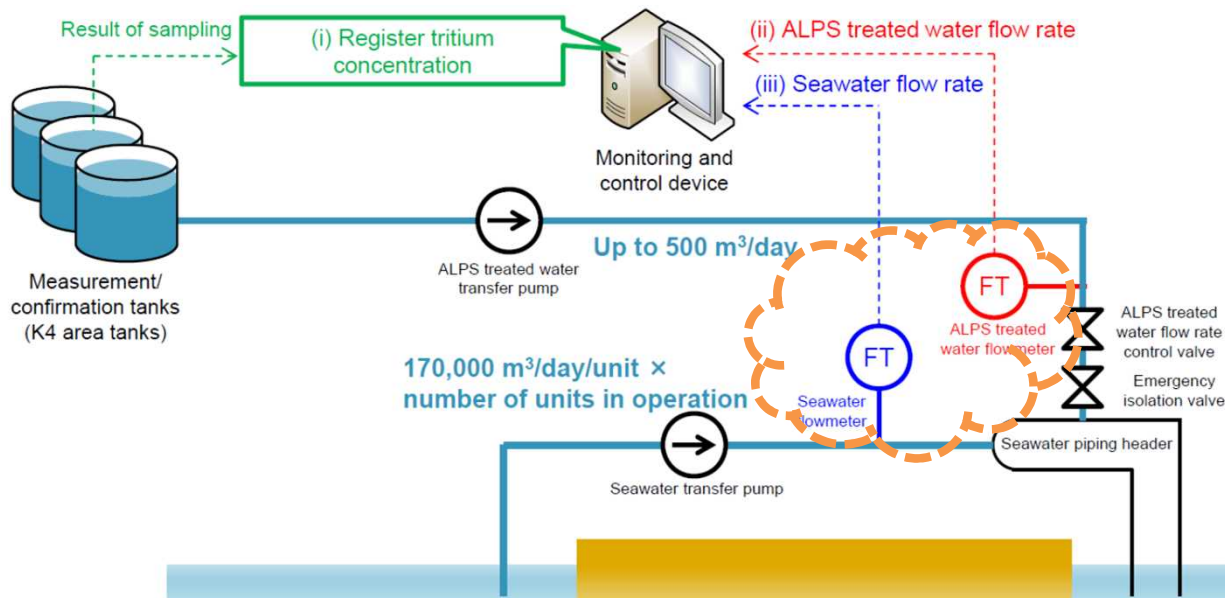

Key point 2: Mixing Simulation

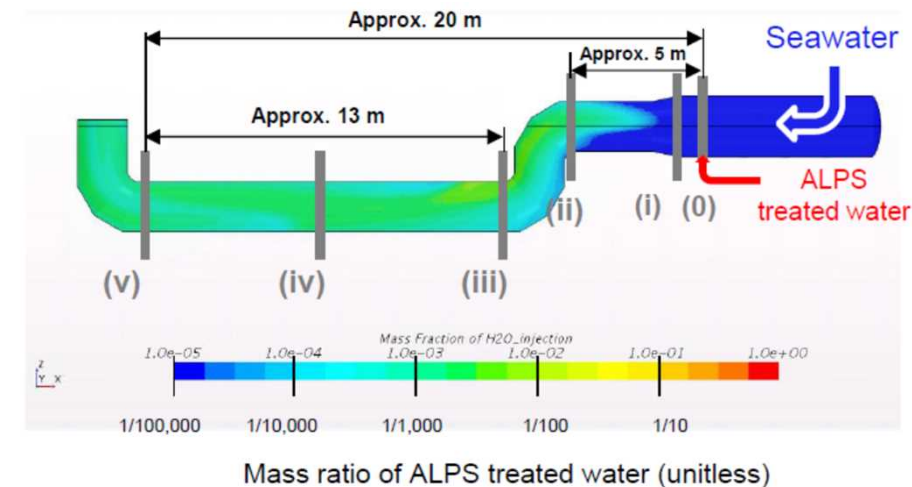



3-2. Treatment, storage, and management of radioactive liquid waste

Method and evaluation of mixing of ALPS treated water with seawater

(3) Comments from the NRA for further clarification

- Design concept and **reliability of flow measurement**
- **Expected measurement errors** of ALPS treated water flowmeter as well as the seawater flowmeter
- In the simulation, the criteria to judge that the concentration is more or less below 1500 Bq/L and also the position to meet the criteria

During the review meetings, TEPCO explained:

- **ALPS treated water flowmeter is to be duplicated.**
- Correction for measurement errors, i.e., plus correction for analytical error, plus correction for ALPS treated water flowmeter and minus correction for seawater flowmeter.
- Limit the concentration of tritium up to 1E+6Bq/L as the most conservative case for simulation
- Simulation to be redone based on the updated design

(4) The NRA's current view on review result

- Pending the result of simulation based on the updated design of the seawater pipe header and the following pipe.



3-3. Radiation protection in the area surrounding the site by restricting release of radioactive materials

(1) Regulatory requirement

II-11. Radiation protection, etc. in the area surrounding the site by restricting release of radioactive

Radiation dose in the area surrounding the site shall be reduced as low as reasonably achievable, taking appropriate measures to restrict release of radioactive materials from the Specified Nuclear Facility into environment (atmosphere, ocean, etc.).

Specifically, effective dose (estimated value taking into account additional releases of radioactive materials from the overall Facility due to rubble and contaminated water, etc. generated after the accident, which are stored in the Facility) along the site boundaries shall be reduced less than **1mSv/year** by March 2013.

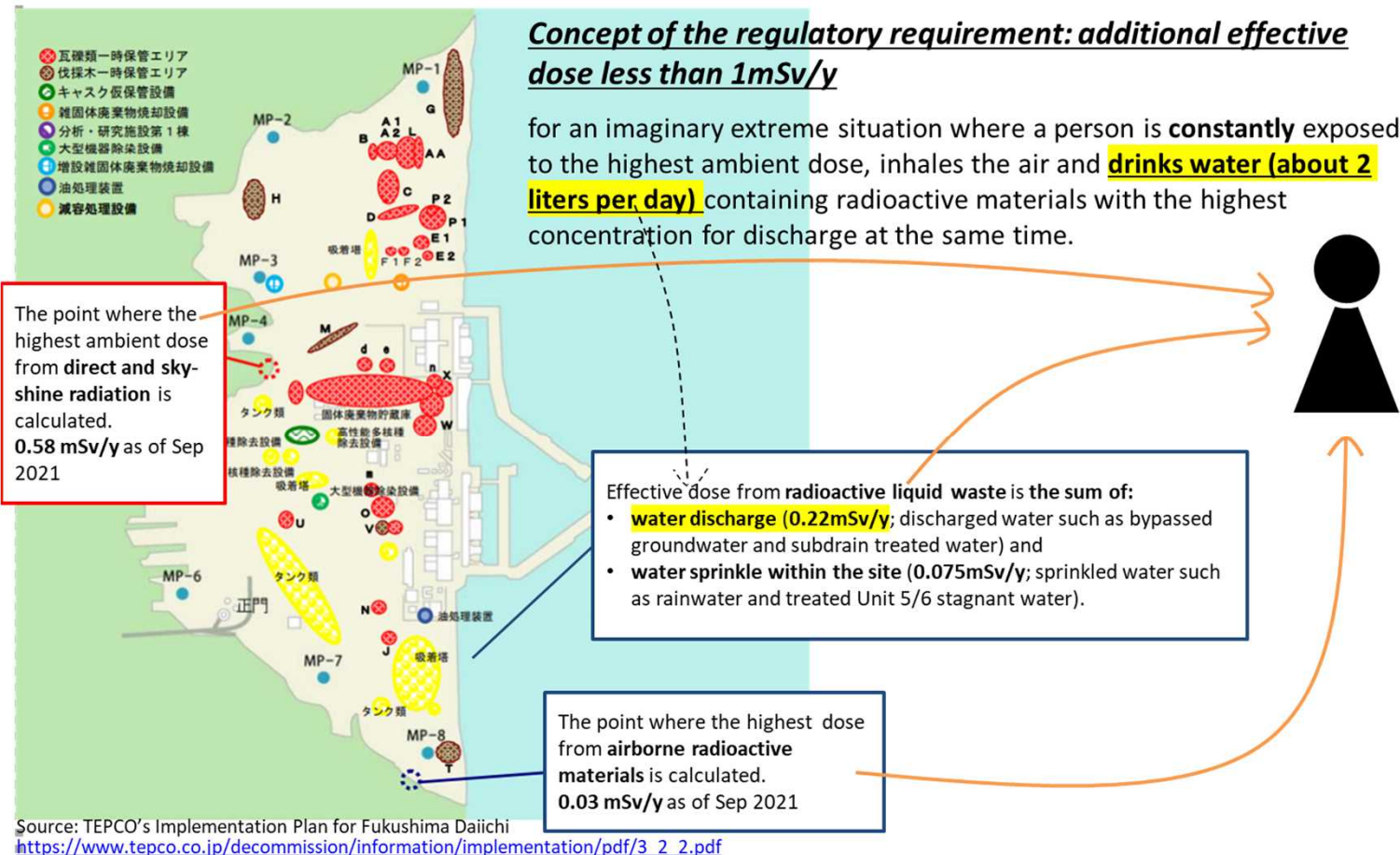



3-3. Radiation protection in the area surrounding the site by restricting release of radioactive materials

During the review meetings, TEPCO explained:

- The contribution of ALPS treated water discharge to the effective dose at the site boundaries is **0.035 mSv/y**. Calculation is as follows.

$$\frac{\text{Concentration of H-3}}{\text{Legally required concentration for H-3}} + \text{sum of ratios of legally required concentrations, with the exception of H-3} \times \frac{1}{\text{Dilution ratio with seawater}}$$
$$= \frac{1500}{60000} + 1 \times \frac{1}{100} = 0.035$$

Source: TEPCO's material at the review meeting on 2022-01-20

- 0.22 mSv/y is the biggest contribution by water discharge. 0.035 mSv/y is lower than this largest value.

(4) Points to be further clarified

- None



3-4. Design considerations

(1) Regulatory requirement

II-14. Design considerations

(1) Applied codes and standards

Design, selection of materials, fabrication and inspection of SSCs with safety function shall conform to those codes and standards which are considered to be appropriate taking into account importance of their safety function, respectively.

(2) Design considerations for natural phenomena

- SSCs with safety function shall be provided with appropriate seismic categories considering the importance of their safety function and possible safety impact caused by loss of function due to **earthquake**, and be designed to sufficiently withstand design seismic load considered to be appropriate.
- SSCs with safety function shall be designed so that the safety of the facilities may not be impaired by postulated natural phenomena other than earthquake (such as **tsunami, heavy rain, typhoon and tornado**, etc.). SSCs with safety function of especially high importance shall be designed taking into account appropriate combination of conditions considered to be severest among predictable natural phenomena or natural load together with accident load.

(3) Design considerations for external human-induced events

- SSCs with safety function shall be designed so that the safety of the facilities may not be impaired by postulated external human-induced events.
- SSCs with safety functions shall be designed to be provided with appropriate means to protect them against any illegal access by outsiders, etc.



3-4. Design considerations

(1) Regulatory requirement

II-14. Design considerations

(4) Design considerations for fire

The facilities shall be designed so that safety may not be impaired by fire, by combining appropriately protective measures such as fire prevention, fire detection, fire extinguishing and mitigation of fire effect.

(5) Design considerations for environmental conditions

SSCs with safety function shall be designed to withstand any environmental conditions, including aging effect. In particular, countermeasures shall be taken with adequate consideration of integrity assessment for the structures affected by the accident and the earthquake, etc.

(7) Design considerations for operability

The facilities shall be designed to be provided with appropriate preventive measures against operators' erroneous operation.

(8) Design considerations for reliability

- SSCs with safety function and monitoring function shall be designed so that their adequately high reliability may be ensured and maintained.

- Systems with safety function of especially high importance shall be designed to achieve their safety function, and shall be designed to be provided with redundancy, diversity and independency, taking into consideration their configuration, operating principle and safety function to be fulfilled.

(9) Design considerations for inspection

SSCs with safety function shall be designed so that their function may be tested to verify their integrity and capability by means of appropriate method.



3-4. Design considerations

Design considerations for natural phenomena

(2) Major points to be clarified by TEPCO

- For each structure, system, and component, safety function and the impact of the loss of safety function
- Measures against natural hazards such as earthquake and tsunami as well as external human-induced events, **taking into account the potential radiological impact**

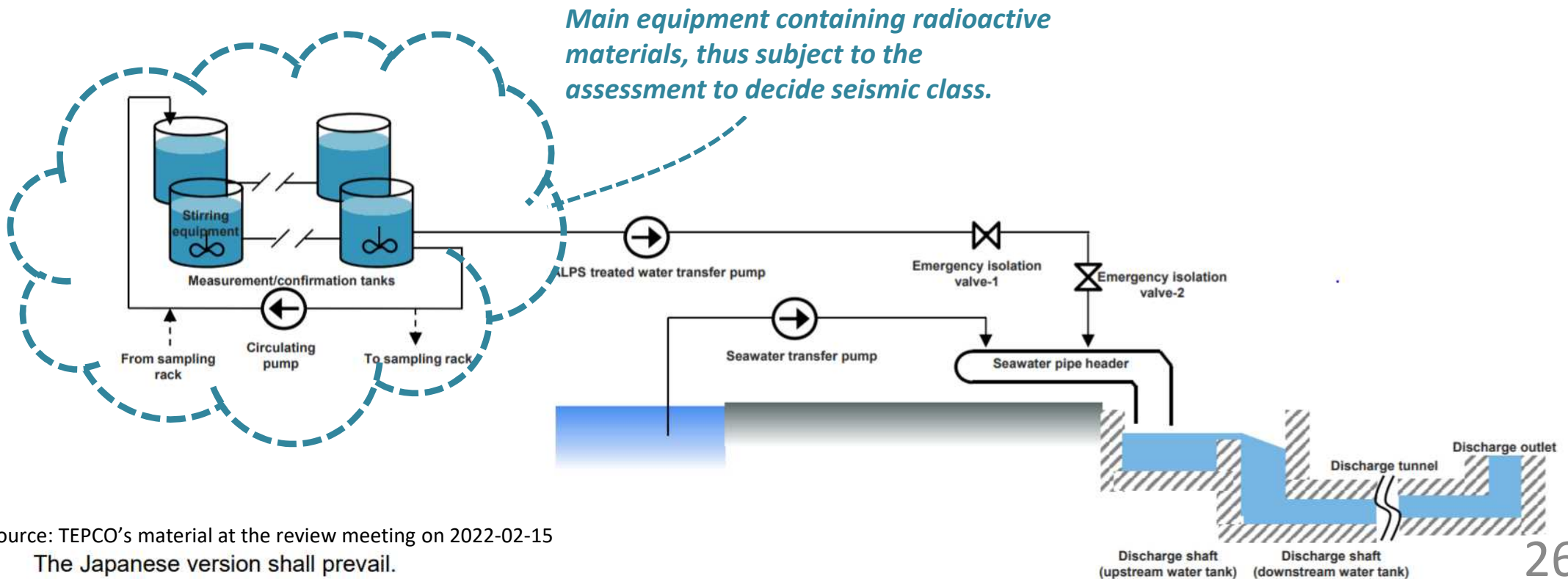



3-4. Design considerations

Design considerations for natural phenomena

Seismic Class

Seismic class for each facility at Fukushima Daiichi site is to be decided according to the potential radiological impact which the facility may give rise to due to the loss of safety function.

Class S: $5 \text{ mSv} < \text{Public dose around the site}$

Class B: $50\mu\text{Sv} < \text{Public dose around the site} \leq 5 \text{ mSv}$

Class C: $\text{Public dose around the site} \leq 50\mu\text{Sv}$

During the review meetings, TEPCO explained that

- **The potential impact is assessed to be $<1\mu\text{Sv}$** assuming the shielding of K4 tanks is lost and ALPS treated water leaked into the weir is evaporated until salvage, thus **Class C**.
- Against potential leakage, the weir around K4 tanks is constructed as Class B.
- Countermeasures to prevent or mitigate the impact of leakage expansion are established.

Seismic ground motion to be applied to Class C is static ground motion 1.0 Ci (0.2 G).



3-4. Design considerations

Design considerations for natural phenomena

(3) Comments from the NRA for further clarification

- **Against the possibility that water cannot be physically discharged due to tsunami or storm surge**, necessary to detect unusual situation using water level indicator at the vertical shaft or tide gauge and stop discharge in such situation
- **Procedures to stop discharge in the event of an earthquake with the certain intensity or stronger or a large tsunami warning**, including the transition of the status of the equipment

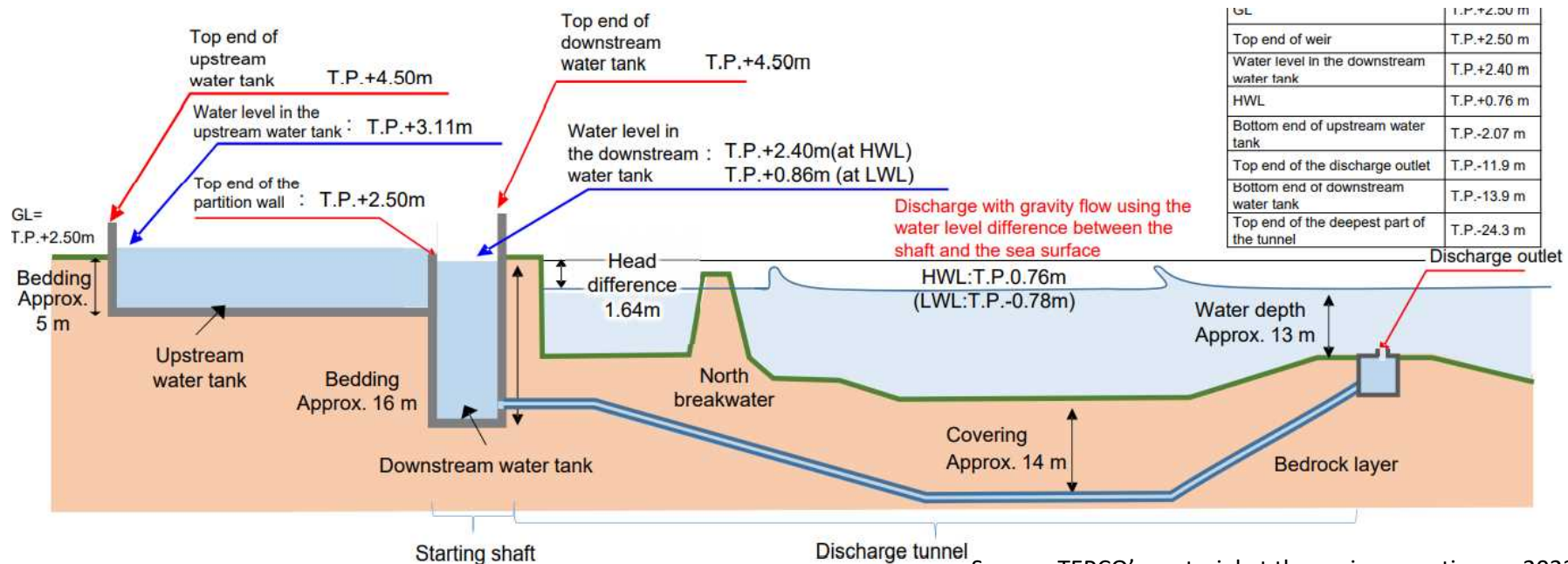



3-4. Design considerations

Design considerations for operability

(3) Comments from the NRA for further clarification

(Prevention of Erroneous Operation)

- With the extent of manual intervention indicated, **necessary to comprehend where and what kind of errors can occur in the whole system and then show how to control them.**
- Measures to prevent erroneous operation such as **interlocks**
- For analysis, how to confirm that the system is reliably processing

During the review meetings, TEPCO explained

- Action flow of operation including for analytical work, and interlock check points
- Manual intervention, expected human errors and countermeasures, e.g., double action and key switch
- Mechanism to check processing done by the system, especially for analytical work



3-4. Design considerations

Design considerations for reliability

(2) Major points to be clarified by TEPCO

Detecting Unusual Situation and Method of Suspending Discharge of ALPS Treated Water

- **For the interlock mechanism, its expected role, logic circuit, and concept of various set limits**

This point is also relevant to safety assessment of facility design (3-6) and operational safety measures (3-5).

(3) Comments from the NRA for further clarification

- Operation and procedures of stopping discharge in each case of closing the emergency isolation valves or otherwise and
- Criterion to judge unusual situations considering the fluctuation between the duplicated ALPS treated water flowmeters, provided unusual situation is detected by the difference in the indicated values of both flowmeters.



3-4. Design considerations

Design considerations for reliability

During the review meetings, TEPCO explained that:

- Valves among 3 Measurement/confirmation tank groups are **set dual-redundantly in series**.
- ALPS treated water flowmeter to monitor dilution rate is **set dual-redundantly by doubling differential pressure detector and signal transmission system**.
- Emergency isolation valve is **set redundantly for closing function and diversely for driving source**, and both valves are fail-safe design in case of the loss of external power supply.

Measurement/
confirmation facilities

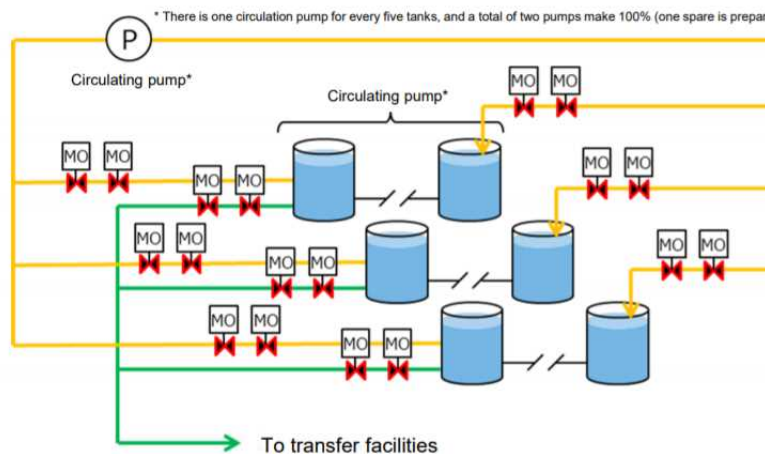

Transfer facilities

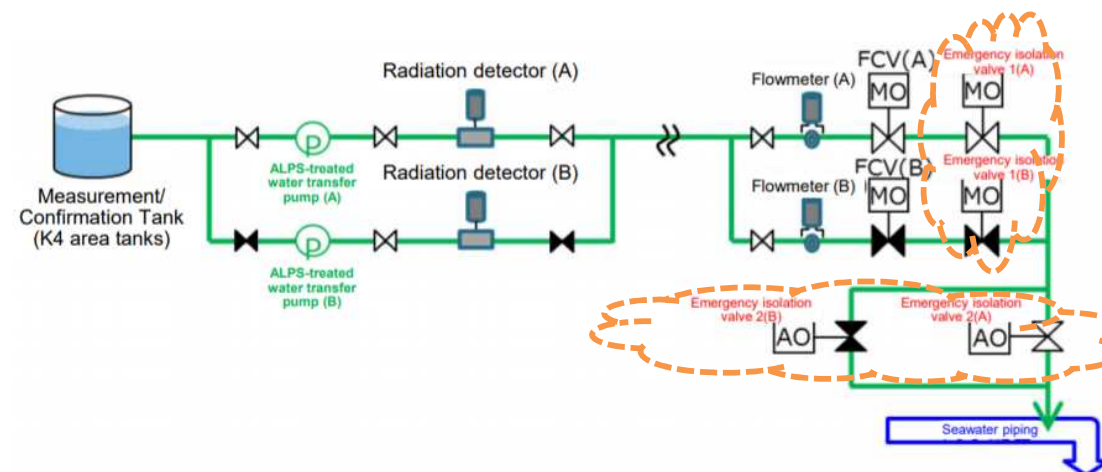



3-4. Design considerations

(4) Points to be further clarified

(2) Design considerations for natural phenomena

- None - waiting for detailed documentation

(7) Design considerations for operability

- None - waiting for detailed documentation

(8) Design considerations for reliability

- None - waiting for detailed documentation



3-5. Measures taken for operational safety of the Specified Nuclear Facility

(1) Regulatory requirement

III. Items concerning Measures Taken for Operational Safety of the Specified Nuclear Facility

By taking appropriate measures such as operation management, maintenance management, radiation control, radioactive waste management, emergency measure and on-site and off-site environmental radiation monitoring, etc., “II. Items concerning Measures to be taken for Design and Facilities” shall be ensured to be appropriately and reliably implemented, and workers’ and on-site and off-site safety shall be ensured. Particularly, with regard to emergency measures during accident or disaster, systems for communication with organizations concerned and medical care in emergency shall be developed in addition to responses to emergency situation. In addition, education and training shall be appropriately conducted for employees and workers including those of contracted and subcontracted companies to maintain and improve their skill and capability.

The methodology for selection nuclides will be covered by another presentation on source term.

Method and organizational framework for analyzing radioactive concentration of nuclides in ALPS treated water

(2) Major points to be clarified by TEPCO

- **Methodology for selecting nuclides** that may affect the dose assessment, other than tritium (H-3), carbon 14 (C-14) and 62 nuclides to be removed by ALPS.



3-5. Measures taken for operational safety of the Specified Nuclear Facility

Method and organizational framework for analyzing radioactive concentration of nuclides in ALPS treated water

(3) Comments from the NRA for further clarification

- Impact of ALPS treated water related analysis to the other analytical work and the present status of securing resources
- Uncertainties contained in the results of analysis
- Analytical methods and their references

(4) Points to be further clarified

- Any nuclide other than the currently defined 64 nuclides would have a sufficiently small contribution based on the measurements and analysis so far.
- Yet to ensure what nuclides exist in ALPS treated water in theory being supported by measurement, the NRA will examine the result of TEPCO's identification of nuclides existing in ALPS treated water at the later stage.



3-5. Measures taken for operational safety of the Specified Nuclear Facility

Measures of suspending discharge of ALPS Treated Water upon unusual occurrences

(4) Points to be further clarified

- Measures of suspending discharge upon unusual occurrences should be documented as operational safety measures.

**Operational Limits
and Conditions**



3-6. Safety assessment of facility design upon unusual occurrences

In order to see the validity of facility design, NRA required TEPCO to conduct safety assessment of facility design upon unusual occurrences.

(2) Major points to be clarified by TEPCO

- Assumed unusual occurrences including component failure
- Equipment, human resources and procedures necessary for dealing with the said event
- **Amount of the unintended discharge**
- Assumption of a single failure of the component that leads to the severest result

(3) Comments from the NRA for further clarification

(Conditions for Assessment)

- **Failure of passive devices** such as leaks due to piping thinning or defective connection

(Equipment, Organization and Procedures Needed to Cope with Unusual Occurrences)

- Specifications and driving sources of **emergency isolation valves**
- Amount of leakage into the weir in the event of a failure of passive equipment



3-6. Safety assessment of facility design upon unusual occurrences

During the review meetings, TEPCO explained that

- **Master Logic Diagram (MLD)** is used to identify unusual occurrences.

* MLD is a top-down analysis method to identify initiating events from top events. Based on this method, it is possible to reveal the initiating events and causes that would result in abnormal events.

	Description
Level 1	Top events, "Unintentional discharge of ALPS-treated water into the ocean" are placed.
Level 2	Three abnormal events defined as top events are placed (see (1) - (3) below).
Level 3	About abnormal events defined in Level 2, specific events that may lead to abnormal events are identified with reference to equipment specifications, P&ID, IBD, equipment layout drawings, and operating procedures, focusing on the functions expected in each process.
Level 4	Equipment single failure or operating error or a single operating error by the operator expected during the service life of the equipment leading up to Level 3 and disturbances expected to occur with similar frequency to the aforementioned are extracted.
Level 5	Relative to the Level 4 initiating events, validity of the measures in the facility design and operation are checked.

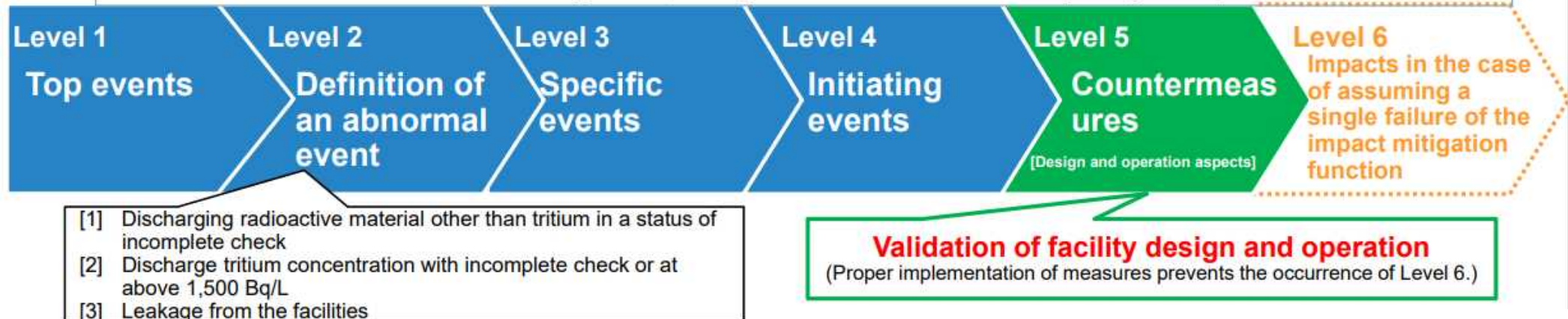

The Japanese version shall prevail.

Evaluation method based on Master Logic Diagram



3-6. Safety assessment of facility design upon unusual occurrences

During the review meetings, TEPCO explained that (cont.)

- **Need of redundancy for ALPS-treated water flowmeter**
- 2 initiating events linked to the 1 same abnormal event “Discharge tritium concentration with incomplete check or at 1,500 Bq/L or above”.
- **Approximately 1.2m³ of unintended discharge**; greatly smaller than the planned discharge amount per day (up to 500m³/day).

- Based on the MLD results, the following were extracted as abnormal events (2) “Discharge tritium concentration with incomplete check or at 1,500 Bq/L or above”.

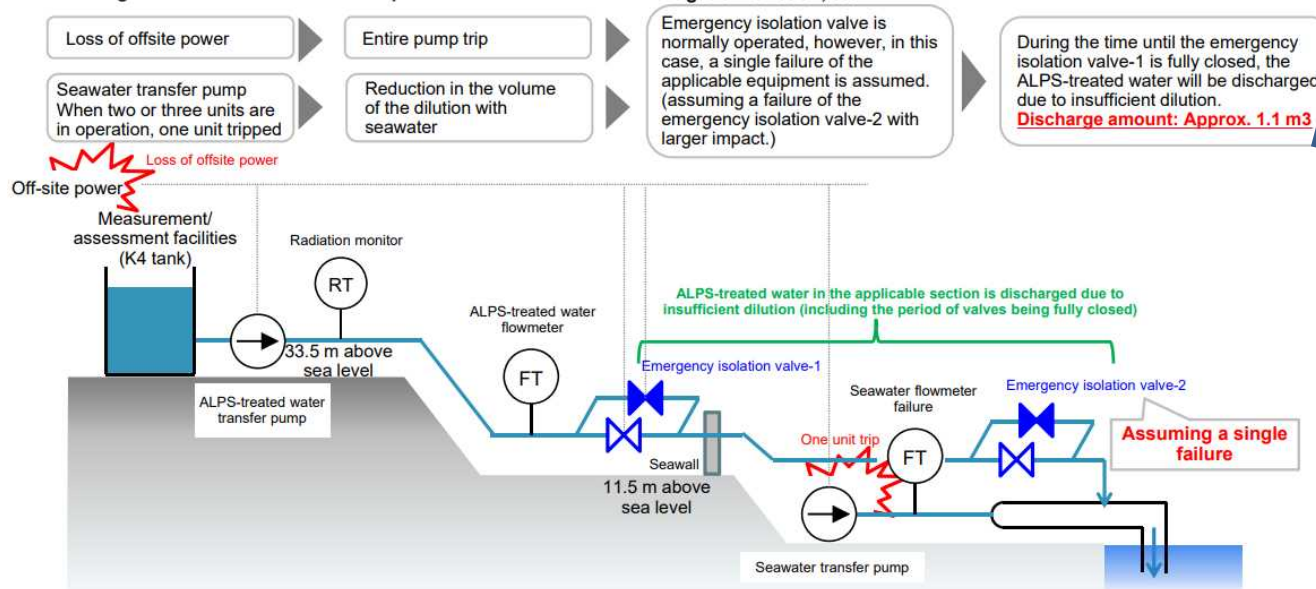

Updated to 1.2m³ at the review meeting on March 18 after scrutinizing the reaction time of emergency isolation valve 1

- It has been confirmed that the applicable discharge amount (approx. 1.1 m3) is sufficiently small compared with the currently planned discharge amount of ALPS-treated water (up to 500 m3/day).
- Based on this, it has been confirmed that the design and operation of the ALPS-treated water dilution/discharge facilities are sufficient for safety.



3-6. Safety assessment of facility design upon unusual occurrences

(4) Points to be further clarified

- None - waiting for detailed documentation



4. Pre-service inspection



4. Pre-service inspection

- After the approval of the Implementation Plan, the NRA will perform the Pre-Service Inspection for facilities related to the discharge of ALPS treated water.
- The Pre-Service Inspection will be performed by NRA Inspectors to confirm that facilities were constructed in a way to comply with the Implementation Plan and have sufficient functionality.
- Equipment to be inspected:
 - Measurement and Analysis equipment : Pump (for circulation), Tank, Piping, Leak and Level Detector
 - Transfer equipment : Pump (for transfer), Tank, Piping, **Radiation monitor, Emergency isolation valve**
 - Mixing equipment : Pump (for transfer), Tank (shaft), Piping, **Flow meter**
 - Discharge equipment : Tank (shaft), Tunnel, Discharge port

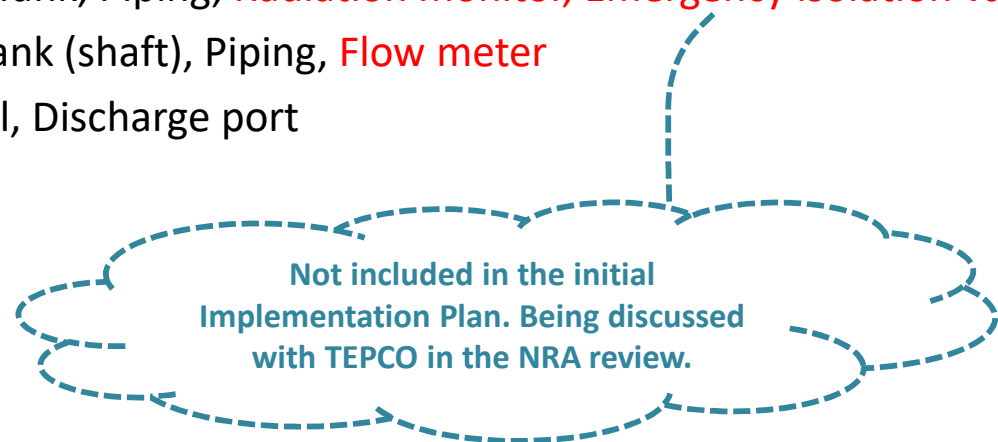



4. Pre-service inspection

NRA inspectors will perform pre-service inspection to confirm the specification at the following each timing:

(i) The facility becomes available for test to confirm structure, strength and leakage

- Materials and size: be manufactured with certain materials and sizes
- Visual observation: no abnormal exterior
- Assembling and location: be assembled and located to comply with the implementation plan
- Pressure and Leakage : resistible to the designed pressure and no leakage

(ii) Installation of the facility is completed

- Performance : Flow and head pressure (Pumps), **Logic test (Isolation Valve), Calibration (Radiation monitor)**
- Level and leakage alert: be able to alert certain water level or leakage rate
- Capacity of the dike : sufficient capacity to prevent overflow

(iii) The entire construction work is complete

- Practical test: No abnormal status, leakage and alert

(Details of the inspection are being discussed through the review of the implementation plan.)

Not included in the initial Implementation Plan. Being discussed with TEPCO in the NRA review.

After the start of discharge: Periodic Inspection

- The NRA will perform the periodic inspection after the facilities be in-service.
- The Periodic Inspection will be performed by NRA Inspectors to confirm that facilities will keep their functionality during the next one year.