

赤字：設備、運用又は体制の相違（設計方針の相違）  
 青字：記載箇所又は記載内容の相違（記載方針の相違）  
 緑字：記載表現、設備名称の相違（実質的な相違なし）

第50条 原子炉格納容器の過圧破損を防止するための設備

大飯発電所3/4号炉	泊発電所3号炉	相違理由
<div data-bbox="183 197 1010 1362" style="border: 2px solid black; height: 730px; width: 369px;"></div> <div data-bbox="183 1362 703 1391" style="border: 1px solid black; padding: 2px;">枠囲みの範囲は機密に係る事項ですので公開することはできません。</div>	<div data-bbox="1144 280 1877 1315" style="border: 2px solid black; height: 648px; width: 327px;"></div> <div data-bbox="1258 1321 1704 1347" style="border: 1px solid black; padding: 2px;">枠囲みの内容は機密情報に属しますので公開できません。</div>	

赤字：設備、運用又は体制の相違（設計方針の相違）  
 青字：記載箇所又は記載内容の相違（記載方針の相違）  
 緑字：記載表現、設備名称の相違（実質的な相違なし）

第50条 原子炉格納容器の過圧破損を防止するための設備

大飯発電所3/4号炉	泊発電所3号炉	相違理由
<div data-bbox="181 204 1003 1369" style="border: 2px solid black; height: 730px; width: 367px;"></div> <div data-bbox="181 1369 696 1401" style="border: 1px solid black; padding: 2px;">枠囲みの範囲は機密に係る事項ですので公開することはできません。</div>	<div data-bbox="1144 280 1872 1315" style="border: 2px solid black; height: 648px; width: 325px;"></div> <div data-bbox="1256 1331 1704 1356" style="border: 1px solid black; padding: 2px;">枠囲みの内容は機密情報に属しますので公開できません。</div>	



赤字：設備、運用又は体制の相違（設計方針の相違）  
 青字：記載箇所又は記載内容の相違（記載方針の相違）  
 緑字：記載表現、設備名称の相違（実質的な相違なし）

大飯発電所3/4号炉

泊発電所3号炉

相違理由

機器又は系統名	実装機(機器名)	名称及び試験の項目	保全の重要度又は程度	保全方式又は程度	検査名	備考 (0)中核設備 (1)重要設備 (2)一般設備
原子炉冷却系施設 [原子炉格納容器冷却海水設備]	原子炉冷却系施設(原子炉格納容器)冷却海水設備 その他の弁	1. 運転・性能試験	高・危	B	1次系弁検査 1次系弁検査	B・ポンプまたは電動機等の分界点後に合わせて実施 先行実施
		2. 分解点検	高・危	130M~200M	1次系弁検査	
		3. 駆動点検	高・危	130M~195M		
		1. 運転・性能試験	高・危	B	1次系弁検査	
		2. 分解点検	高・危	65M~182M		
		3. 駆動点検	高・危	13M~182M		
		4. 分解点検	高	65M~130M		
		2. 分解点検	高	13M~65M		
		1. 運転・性能試験	高	13M~130M		
		2. 分解点検	高	13M~130M		
原子炉格納容器冷却海水設備	A. 通水ポンプ・電動機	1. 運転・性能試験	高	1F	原子炉格納容器冷却海水設備検査	B・ポンプまたは電動機等の分界点後に合わせて実施 先行実施
		2. 分解点検	高	B*	2次系ポンプ駆動検査	
		3. 駆動点検	高	52M	2次系ポンプ分解検査	
		4. 駆動点検	高	65M		
		4. 駆動点検	高	13M		
		1. 運転・性能試験	高	B*	2次系ポンプ駆動検査	
		2. 分解点検	高	52M	2次系ポンプ分解検査	
		3. 駆動点検	高	65M		
		4. 駆動点検	高	13M		
		1. 運転・性能試験	高	B*	2次系ポンプ駆動検査	
原子炉格納容器冷却海水設備	B. 海水ポンプ・電動機	1. 運転・性能試験	高	B*	2次系ポンプ駆動検査	B・ポンプまたは電動機等の分界点後に合わせて実施 先行実施
		2. 分解点検	高	52M	2次系ポンプ分解検査	
		3. 駆動点検	高	65M		
		4. 駆動点検	高	13M		
		1. 運転・性能試験	高	B*	2次系ポンプ駆動検査	
		2. 分解点検	高	52M	2次系ポンプ分解検査	
		3. 駆動点検	高	65M		
		4. 駆動点検	高	13M		
		1. 運転・性能試験	高	B*	2次系ポンプ駆動検査	
		原子炉格納容器冷却海水設備	C. 海水ポンプ・電動機	1. 運転・性能試験	高	
2. 分解点検	高			52M	2次系ポンプ分解検査	
3. 駆動点検	高			65M		
4. 駆動点検	高			13M		
1. 運転・性能試験	高			B*	2次系ポンプ駆動検査	
2. 分解点検	高			52M	2次系ポンプ分解検査	
3. 駆動点検	高			65M		
4. 駆動点検	高			13M		
1. 運転・性能試験	高			B*	2次系ポンプ駆動検査	

比較のため前項より転記

別紙1-146

機器又は系統名	実装機(機器名)	名称及び試験の項目	保全の重要度又は程度	保全方式又は程度	検査名	備考 (0)中核設備 (1)重要設備 (2)一般設備
原子炉冷却系施設 [原子炉格納容器冷却海水設備]	原子炉冷却系施設(原子炉格納容器)冷却海水設備 その他の弁	1. 運転・性能試験	高・危	B	1次系弁検査 1次系弁検査	B・ポンプまたは電動機等の分界点後に合わせて実施 先行実施
		2. 分解点検	高・危	130M~200M	1次系弁検査	
		3. 駆動点検	高・危	130M~195M		
		1. 運転・性能試験	高・危	B	1次系弁検査	
		2. 分解点検	高・危	65M~182M		
		3. 駆動点検	高・危	13M~182M		
		4. 分解点検	高	65M~130M		
		2. 分解点検	高	13M~65M		
		1. 運転・性能試験	高	13M~130M		
		2. 分解点検	高	13M~130M		
原子炉格納容器冷却海水設備	A. 通水ポンプ・電動機	1. 運転・性能試験	高	1F	原子炉格納容器冷却海水設備検査	B・ポンプまたは電動機等の分界点後に合わせて実施 先行実施
		2. 分解点検	高	B*	2次系ポンプ駆動検査	
		3. 駆動点検	高	52M	2次系ポンプ分解検査	
		4. 駆動点検	高	65M		
		4. 駆動点検	高	13M		
		1. 運転・性能試験	高	B*	2次系ポンプ駆動検査	
		2. 分解点検	高	52M	2次系ポンプ分解検査	
		3. 駆動点検	高	65M		
		4. 駆動点検	高	13M		
		1. 運転・性能試験	高	B*	2次系ポンプ駆動検査	
原子炉格納容器冷却海水設備	B. 海水ポンプ・電動機	1. 運転・性能試験	高	B*	2次系ポンプ駆動検査	B・ポンプまたは電動機等の分界点後に合わせて実施 先行実施
		2. 分解点検	高	52M	2次系ポンプ分解検査	
		3. 駆動点検	高	65M		
		4. 駆動点検	高	13M		
		1. 運転・性能試験	高	B*	2次系ポンプ駆動検査	
		2. 分解点検	高	52M	2次系ポンプ分解検査	
		3. 駆動点検	高	65M		
		4. 駆動点検	高	13M		
		1. 運転・性能試験	高	B*	2次系ポンプ駆動検査	
		原子炉格納容器冷却海水設備	C. 海水ポンプ・電動機	1. 運転・性能試験	高	
2. 分解点検	高			52M	2次系ポンプ分解検査	
3. 駆動点検	高			65M		
4. 駆動点検	高			13M		
1. 運転・性能試験	高			B*	2次系ポンプ駆動検査	
2. 分解点検	高			52M	2次系ポンプ分解検査	
3. 駆動点検	高			65M		
4. 駆動点検	高			13M		
1. 運転・性能試験	高			B*	2次系ポンプ駆動検査	

別紙1-23

試原-146

赤字：設備、運用又は体制の相違（設計方針の相違）  
 青字：記載箇所又は記載内容の相違（記載方針の相違）  
 緑字：記載表現、設備名称の相違（実質的な相違なし）

大飯発電所3/4号炉	泊発電所3号炉	相違理由
<p style="text-align: center;"><u>改 2</u></p> <p style="text-align: center;">関西電力株式会社 大飯発電所                      第3号機 第16保全サイクル                      定期事業者検査要領書</p> <p>施設名：原子炉冷却系統施設（蒸気タービンを除く。）                      蒸気タービンの附属設備                      検査名：2次系ポンプ分解検査                      要領書番号：O3-16-349</p>	<p style="text-align: center;">北海道電力株式会社 泊発電所                      3号機 第2保全サイクル                      定期事業者検査要領書</p> <p>設備名：原子炉冷却系統設備                      検査名：1次系ポンプ分解検査                      要領書番号：HT3-82</p> <p style="text-align: right;">試原-147</p>	

赤字：設備、運用又は体制の相違（設計方針の相違）  
 青字：記載箇所又は記載内容の相違（記載方針の相違）  
 緑字：記載表現、設備名称の相違（実質的な相違なし）

第50条 原子炉格納容器の過圧破損を防止するための設備

大飯発電所3/4号炉	泊発電所3号炉	相違理由
<div data-bbox="188 197 1014 1362" style="border: 2px solid black; height: 730px; width: 369px;"></div> <div data-bbox="188 1362 707 1390" style="border: 1px solid black; padding: 2px;">                     枠囲みの範囲は機密に係る事項ですので公開することはできません。                 </div>	<div data-bbox="1140 284 1877 1315" style="border: 2px solid black; height: 646px; width: 329px;"></div> <div data-bbox="1256 1334 1704 1358" style="border: 1px solid black; padding: 2px;">                     枠囲みの内容は機密情報に属しますので公開できません。                 </div>	

赤字：設備、運用又は体制の相違（設計方針の相違）  
 青字：記載箇所又は記載内容の相違（記載方針の相違）  
 緑字：記載表現、設備名称の相違（実質的な相違なし）

第50条 原子炉格納容器の過圧破損を防止するための設備

大飯発電所3/4号炉	泊発電所3号炉	相違理由
<p style="text-align: center;">改 1</p> <p style="text-align: center;">関西電力株式会社 大飯発電所                      第3号機 第16保全サイクル                      定期事業者検査要領書</p> <p>施設名：原子炉冷却系統施設（蒸気タービンを除く。）                      蒸気タービンの附属設備                      検査名：2次系ポンプ機能検査                      要領書番号：O3-16-350</p>	<p style="text-align: center;">北海道電力株式会社 泊発電所                      3号機 第2保全サイクル                      定期事業者検査要領書</p> <p>設備名：原子炉冷却系統設備                      計測制御系統設備                      燃料設備                      検査名：1次系ポンプ機能検査                      要領書番号：HT3-83</p> <p style="text-align: right;">試原-149</p>	

赤字：設備、運用又は体制の相違（設計方針の相違）  
 青字：記載箇所又は記載内容の相違（記載方針の相違）  
 緑字：記載表現、設備名称の相違（実質的な相違なし）

第50条 原子炉格納容器の過圧破損を防止するための設備

大飯発電所3 / 4号炉	泊発電所3号炉	相違理由
<div data-bbox="185 201 1010 1369" style="border: 2px solid black; height: 732px; width: 368px;"></div> <div data-bbox="185 1369 698 1394" style="border: 1px solid black; padding: 2px;">枠囲みの範囲は機密に係る事項ですので公開することはできません。</div>	<div data-bbox="1144 280 1877 1315" style="border: 2px solid black; height: 648px; width: 327px;"></div> <div data-bbox="1261 1321 1704 1347" style="border: 1px solid black; padding: 2px;">枠囲みの内容は機密情報に属しますので公開できません。</div>	<p>資料構成の相違</p> <ul style="list-style-type: none"> <li>・泊の定期事業者検査要領書では、試験対象設備について設備概要を作成していないが、設備概要は、当該定期事業者検査要領書において対象SA設備が含まれることを示す書類である。</li> <li>・泊では、対象SA設備に関する記載のある定期事業者検査要領書の構成書類を示しており、いずれの関連書類においても、対象SA設備が定期事業者検査対象として検査実績があることを示しており、試験検査対象を示していることに相違はない。</li> </ul>



赤字：設備、運用又は体制の相違（設計方針の相違）  
 青字：記載箇所又は記載内容の相違（記載方針の相違）  
 緑字：記載表現、設備名称の相違（実質的な相違なし）

大飯発電所3/4号炉	泊発電所3号炉	相違理由
<p style="text-align: center;">改 1</p> <p style="text-align: center;">関西電力株式会社 大飯発電所                      第3号機 第16保全サイクル                      定期事業者検査要領書</p> <p>施設名：原子炉冷却系統施設（蒸気タービンを除く。）                      検査名：原子炉補機冷却系機能検査                      要領書番号：O3-16-129</p>		<p>保全計画の相違</p> <ul style="list-style-type: none"> <li>対象設備の保全内容、検査項目の設定に相違はあるが、対象とするSA設備が保全対象として設定され、点検計画を定めていることを示しており、大飯・泊とも点検対象として試験検査を行う計画であることに相違はない。</li> </ul>

赤字：設備、運用又は体制の相違（設計方針の相違）  
 青字：記載箇所又は記載内容の相違（記載方針の相違）  
 緑字：記載表現、設備名称の相違（実質的な相違なし）

第50条 原子炉格納容器の過圧破損を防止するための設備

大飯発電所3 / 4号炉	泊発電所3号炉	相違理由
<div data-bbox="192 193 1014 1358" style="border: 2px solid black; height: 730px; width: 367px; margin: 10px auto;"></div> <div data-bbox="192 1361 707 1385" style="border: 1px solid black; padding: 2px; margin-top: 5px;">                     持込みの範囲は機密に係る事項ですので公開することはできません。                 </div>		保全計画の相違 ・対象設備の保全内容、検査項目の設定に相違はあるが、対象とするSA設備が保全対象として設定され、点検計画を定めていることを示しており、大飯・泊とも点検対象として試験検査を行う計画であることに相違はない。



赤字：設備、運用又は体制の相違（設計方針の相違）  
 青字：記載箇所又は記載内容の相違（記載方針の相違）  
 緑字：記載表現、設備名称の相違（実質的な相違なし）

第50条 原子炉格納容器の過圧破損を防止するための設備

大飯発電所3 / 4号炉	泊発電所3号炉	相違理由
<div data-bbox="183 194 1012 1362" style="border: 2px solid black; height: 732px; width: 370px; margin: 10px auto;"></div> <div data-bbox="190 1362 703 1390" style="border: 1px solid black; padding: 2px; width: fit-content;">枠囲みの範囲は機密に係る事項ですので公開することはできません。</div>	<div data-bbox="1142 280 1877 1315" style="border: 2px solid black; height: 648px; width: 328px; margin: 10px auto;"></div> <div data-bbox="1258 1334 1704 1358" style="border: 1px solid black; padding: 2px; width: fit-content; margin-left: auto;">枠囲みの内容は機密情報に属しますので公開できません。</div>	

赤字：設備、運用又は体制の相違（設計方針の相違）  
 青字：記載箇所又は記載内容の相違（記載方針の相違）  
 緑字：記載表現、設備名称の相違（実質的な相違なし）

大飯発電所 3 / 4 号炉	泊発電所 3 号炉	相違理由																																																																																																																																																																																																																																																																																																																																																																																																																																																																																																																				
	<p style="text-align: center;">添付資料-2 (注)(4)</p> <table border="1" style="width: 100%; border-collapse: collapse;"> <thead> <tr> <th>備考</th> <th>設備名</th> <th>設備仕様</th> <th>設備仕様</th> <th>備考</th> </tr> </thead> <tbody> <tr> <td></td> <td>7.2.M</td> <td>7.2.M</td> <td>7.2.M</td> <td></td> </tr> <tr> <td></td> <td>7.3.M</td> <td>7.3.M</td> <td>7.3.M</td> <td></td> </tr> <tr> <td></td> <td>7.4.M</td> <td>7.4.M</td> <td>7.4.M</td> <td></td> </tr> <tr> <td></td> <td>7.5.M</td> <td>7.5.M</td> <td>7.5.M</td> <td></td> </tr> <tr> <td></td> <td>7.6.M</td> <td>7.6.M</td> <td>7.6.M</td> <td></td> </tr> <tr> <td></td> <td>7.7.M</td> <td>7.7.M</td> <td>7.7.M</td> <td></td> </tr> <tr> <td></td> <td>7.8.M</td> <td>7.8.M</td> <td>7.8.M</td> <td></td> </tr> <tr> <td></td> <td>7.9.M</td> <td>7.9.M</td> <td>7.9.M</td> <td></td> </tr> <tr> <td></td> <td>7.10.M</td> <td>7.10.M</td> <td>7.10.M</td> <td></td> </tr> <tr> <td></td> <td>7.11.M</td> <td>7.11.M</td> <td>7.11.M</td> <td></td> </tr> <tr> <td></td> <td>7.12.M</td> <td>7.12.M</td> <td>7.12.M</td> <td></td> </tr> <tr> <td></td> <td>7.13.M</td> <td>7.13.M</td> <td>7.13.M</td> <td></td> </tr> <tr> <td></td> <td>7.14.M</td> <td>7.14.M</td> <td>7.14.M</td> <td></td> </tr> <tr> <td></td> <td>7.15.M</td> <td>7.15.M</td> <td>7.15.M</td> <td></td> </tr> <tr> <td></td> <td>7.16.M</td> <td>7.16.M</td> <td>7.16.M</td> <td></td> </tr> <tr> <td></td> <td>7.17.M</td> <td>7.17.M</td> <td>7.17.M</td> <td></td> </tr> <tr> <td></td> <td>7.18.M</td> <td>7.18.M</td> <td>7.18.M</td> <td></td> </tr> <tr> <td></td> <td>7.19.M</td> <td>7.19.M</td> <td>7.19.M</td> <td></td> </tr> <tr> <td></td> <td>7.20.M</td> <td>7.20.M</td> <td>7.20.M</td> <td></td> </tr> <tr> <td></td> <td>7.21.M</td> <td>7.21.M</td> <td>7.21.M</td> <td></td> </tr> <tr> <td></td> <td>7.22.M</td> <td>7.22.M</td> <td>7.22.M</td> <td></td> </tr> <tr> <td></td> <td>7.23.M</td> <td>7.23.M</td> <td>7.23.M</td> <td></td> </tr> <tr> <td></td> <td>7.24.M</td> <td>7.24.M</td> <td>7.24.M</td> <td></td> </tr> <tr> <td></td> <td>7.25.M</td> <td>7.25.M</td> <td>7.25.M</td> <td></td> </tr> <tr> <td></td> <td>7.26.M</td> <td>7.26.M</td> <td>7.26.M</td> <td></td> </tr> <tr> <td></td> <td>7.27.M</td> <td>7.27.M</td> <td>7.27.M</td> <td></td> </tr> <tr> <td></td> <td>7.28.M</td> <td>7.28.M</td> <td>7.28.M</td> <td></td> </tr> <tr> <td></td> <td>7.29.M</td> <td>7.29.M</td> <td>7.29.M</td> <td></td> </tr> <tr> <td></td> <td>7.30.M</td> <td>7.30.M</td> <td>7.30.M</td> <td></td> </tr> <tr> <td></td> <td>7.31.M</td> <td>7.31.M</td> <td>7.31.M</td> <td></td> </tr> <tr> <td></td> <td>7.32.M</td> <td>7.32.M</td> <td>7.32.M</td> <td></td> </tr> <tr> <td></td> <td>7.33.M</td> <td>7.33.M</td> <td>7.33.M</td> <td></td> </tr> <tr> <td></td> <td>7.34.M</td> <td>7.34.M</td> <td>7.34.M</td> <td></td> </tr> <tr> <td></td> <td>7.35.M</td> <td>7.35.M</td> <td>7.35.M</td> <td></td> </tr> <tr> <td></td> <td>7.36.M</td> <td>7.36.M</td> <td>7.36.M</td> <td></td> </tr> <tr> <td></td> <td>7.37.M</td> <td>7.37.M</td> <td>7.37.M</td> <td></td> </tr> <tr> <td></td> <td>7.38.M</td> <td>7.38.M</td> <td>7.38.M</td> <td></td> </tr> <tr> <td></td> <td>7.39.M</td> <td>7.39.M</td> <td>7.39.M</td> <td></td> </tr> <tr> <td></td> <td>7.40.M</td> <td>7.40.M</td> <td>7.40.M</td> <td></td> </tr> <tr> <td></td> <td>7.41.M</td> <td>7.41.M</td> <td>7.41.M</td> <td></td> </tr> <tr> <td></td> <td>7.42.M</td> <td>7.42.M</td> <td>7.42.M</td> <td></td> </tr> <tr> <td></td> <td>7.43.M</td> <td>7.43.M</td> <td>7.43.M</td> <td></td> </tr> <tr> <td></td> <td>7.44.M</td> <td>7.44.M</td> <td>7.44.M</td> <td></td> </tr> <tr> <td></td> <td>7.45.M</td> <td>7.45.M</td> <td>7.45.M</td> <td></td> </tr> <tr> <td></td> <td>7.46.M</td> <td>7.46.M</td> <td>7.46.M</td> <td></td> </tr> <tr> <td></td> <td>7.47.M</td> <td>7.47.M</td> <td>7.47.M</td> <td></td> </tr> <tr> <td></td> <td>7.48.M</td> <td>7.48.M</td> <td>7.48.M</td> <td></td> </tr> <tr> <td></td> <td>7.49.M</td> <td>7.49.M</td> <td>7.49.M</td> <td></td> </tr> <tr> <td></td> <td>7.50.M</td> <td>7.50.M</td> <td>7.50.M</td> <td></td> </tr> <tr> <td></td> <td>7.51.M</td> <td>7.51.M</td> <td>7.51.M</td> <td></td> </tr> <tr> <td></td> <td>7.52.M</td> <td>7.52.M</td> <td>7.52.M</td> <td></td> </tr> <tr> <td></td> <td>7.53.M</td> <td>7.53.M</td> <td>7.53.M</td> <td></td> </tr> <tr> <td></td> <td>7.54.M</td> <td>7.54.M</td> <td>7.54.M</td> <td></td> </tr> <tr> <td></td> <td>7.55.M</td> <td>7.55.M</td> <td>7.55.M</td> <td></td> </tr> <tr> <td></td> <td>7.56.M</td> <td>7.56.M</td> <td>7.56.M</td> <td></td> </tr> <tr> <td></td> <td>7.57.M</td> <td>7.57.M</td> <td>7.57.M</td> <td></td> </tr> <tr> <td></td> <td>7.58.M</td> <td>7.58.M</td> <td>7.58.M</td> <td></td> </tr> <tr> <td></td> <td>7.59.M</td> <td>7.59.M</td> <td>7.59.M</td> <td></td> </tr> <tr> <td></td> <td>7.60.M</td> <td>7.60.M</td> <td>7.60.M</td> <td></td> </tr> <tr> <td></td> <td>7.61.M</td> <td>7.61.M</td> <td>7.61.M</td> <td></td> </tr> <tr> <td></td> <td>7.62.M</td> <td>7.62.M</td> <td>7.62.M</td> <td></td> </tr> <tr> <td></td> <td>7.63.M</td> <td>7.63.M</td> <td>7.63.M</td> <td></td> </tr> <tr> <td></td> <td>7.64.M</td> <td>7.64.M</td> <td>7.64.M</td> <td></td> </tr> <tr> <td></td> <td>7.65.M</td> <td>7.65.M</td> <td>7.65.M</td> <td></td> </tr> <tr> <td></td> <td>7.66.M</td> <td>7.66.M</td> <td>7.66.M</td> <td></td> </tr> <tr> <td></td> <td>7.67.M</td> <td>7.67.M</td> <td>7.67.M</td> <td></td> </tr> <tr> <td></td> <td>7.68.M</td> <td>7.68.M</td> <td>7.68.M</td> <td></td> </tr> <tr> <td></td> <td>7.69.M</td> <td>7.69.M</td> <td>7.69.M</td> <td></td> </tr> <tr> <td></td> <td>7.70.M</td> <td>7.70.M</td> <td>7.70.M</td> <td></td> </tr> <tr> <td></td> <td>7.71.M</td> <td>7.71.M</td> <td>7.71.M</td> <td></td> </tr> <tr> <td></td> <td>7.72.M</td> <td>7.72.M</td> <td>7.72.M</td> <td></td> </tr> <tr> <td></td> <td>7.73.M</td> <td>7.73.M</td> <td>7.73.M</td> <td></td> </tr> <tr> <td></td> <td>7.74.M</td> <td>7.74.M</td> <td>7.74.M</td> <td></td> </tr> <tr> <td></td> <td>7.75.M</td> <td>7.75.M</td> <td>7.75.M</td> <td></td> </tr> <tr> <td></td> <td>7.76.M</td> <td>7.76.M</td> <td>7.76.M</td> <td></td> </tr> <tr> <td></td> <td>7.77.M</td> <td>7.77.M</td> <td>7.77.M</td> <td></td> </tr> <tr> <td></td> <td>7.78.M</td> <td>7.78.M</td> <td>7.78.M</td> <td></td> </tr> <tr> <td></td> <td>7.79.M</td> <td>7.79.M</td> <td>7.79.M</td> <td></td> </tr> <tr> <td></td> <td>7.80.M</td> <td>7.80.M</td> <td>7.80.M</td> <td></td> </tr> <tr> <td></td> <td>7.81.M</td> <td>7.81.M</td> <td>7.81.M</td> <td></td> </tr> <tr> <td></td> <td>7.82.M</td> <td>7.82.M</td> <td>7.82.M</td> <td></td> </tr> <tr> <td></td> <td>7.83.M</td> <td>7.83.M</td> <td>7.83.M</td> <td></td> </tr> <tr> <td></td> <td>7.84.M</td> <td>7.84.M</td> <td>7.84.M</td> <td></td> </tr> <tr> <td></td> <td>7.85.M</td> <td>7.85.M</td> <td>7.85.M</td> <td></td> </tr> <tr> <td></td> <td>7.86.M</td> <td>7.86.M</td> <td>7.86.M</td> <td></td> </tr> <tr> <td></td> <td>7.87.M</td> <td>7.87.M</td> <td>7.87.M</td> <td></td> </tr> <tr> <td></td> <td>7.88.M</td> <td>7.88.M</td> <td>7.88.M</td> <td></td> </tr> <tr> <td></td> <td>7.89.M</td> <td>7.89.M</td> <td>7.89.M</td> <td></td> </tr> <tr> <td></td> <td>7.90.M</td> <td>7.90.M</td> <td>7.90.M</td> <td></td> </tr> <tr> <td></td> <td>7.91.M</td> <td>7.91.M</td> <td>7.91.M</td> <td></td> </tr> <tr> <td></td> <td>7.92.M</td> <td>7.92.M</td> <td>7.92.M</td> <td></td> </tr> <tr> <td></td> <td>7.93.M</td> <td>7.93.M</td> <td>7.93.M</td> <td></td> </tr> <tr> <td></td> <td>7.94.M</td> <td>7.94.M</td> <td>7.94.M</td> <td></td> </tr> <tr> <td></td> <td>7.95.M</td> <td>7.95.M</td> <td>7.95.M</td> <td></td> </tr> <tr> <td></td> <td>7.96.M</td> <td>7.96.M</td> <td>7.96.M</td> <td></td> </tr> <tr> <td></td> <td>7.97.M</td> <td>7.97.M</td> <td>7.97.M</td> <td></td> </tr> <tr> <td></td> <td>7.98.M</td> <td>7.98.M</td> <td>7.98.M</td> <td></td> </tr> <tr> <td></td> <td>7.99.M</td> <td>7.99.M</td> <td>7.99.M</td> <td></td> </tr> <tr> <td></td> <td>7.100.M</td> <td>7.100.M</td> <td>7.100.M</td> <td></td> </tr> </tbody> </table>	備考	設備名	設備仕様	設備仕様	備考		7.2.M	7.2.M	7.2.M			7.3.M	7.3.M	7.3.M			7.4.M	7.4.M	7.4.M			7.5.M	7.5.M	7.5.M			7.6.M	7.6.M	7.6.M			7.7.M	7.7.M	7.7.M			7.8.M	7.8.M	7.8.M			7.9.M	7.9.M	7.9.M			7.10.M	7.10.M	7.10.M			7.11.M	7.11.M	7.11.M			7.12.M	7.12.M	7.12.M			7.13.M	7.13.M	7.13.M			7.14.M	7.14.M	7.14.M			7.15.M	7.15.M	7.15.M			7.16.M	7.16.M	7.16.M			7.17.M	7.17.M	7.17.M			7.18.M	7.18.M	7.18.M			7.19.M	7.19.M	7.19.M			7.20.M	7.20.M	7.20.M			7.21.M	7.21.M	7.21.M			7.22.M	7.22.M	7.22.M			7.23.M	7.23.M	7.23.M			7.24.M	7.24.M	7.24.M			7.25.M	7.25.M	7.25.M			7.26.M	7.26.M	7.26.M			7.27.M	7.27.M	7.27.M			7.28.M	7.28.M	7.28.M			7.29.M	7.29.M	7.29.M			7.30.M	7.30.M	7.30.M			7.31.M	7.31.M	7.31.M			7.32.M	7.32.M	7.32.M			7.33.M	7.33.M	7.33.M			7.34.M	7.34.M	7.34.M			7.35.M	7.35.M	7.35.M			7.36.M	7.36.M	7.36.M			7.37.M	7.37.M	7.37.M			7.38.M	7.38.M	7.38.M			7.39.M	7.39.M	7.39.M			7.40.M	7.40.M	7.40.M			7.41.M	7.41.M	7.41.M			7.42.M	7.42.M	7.42.M			7.43.M	7.43.M	7.43.M			7.44.M	7.44.M	7.44.M			7.45.M	7.45.M	7.45.M			7.46.M	7.46.M	7.46.M			7.47.M	7.47.M	7.47.M			7.48.M	7.48.M	7.48.M			7.49.M	7.49.M	7.49.M			7.50.M	7.50.M	7.50.M			7.51.M	7.51.M	7.51.M			7.52.M	7.52.M	7.52.M			7.53.M	7.53.M	7.53.M			7.54.M	7.54.M	7.54.M			7.55.M	7.55.M	7.55.M			7.56.M	7.56.M	7.56.M			7.57.M	7.57.M	7.57.M			7.58.M	7.58.M	7.58.M			7.59.M	7.59.M	7.59.M			7.60.M	7.60.M	7.60.M			7.61.M	7.61.M	7.61.M			7.62.M	7.62.M	7.62.M			7.63.M	7.63.M	7.63.M			7.64.M	7.64.M	7.64.M			7.65.M	7.65.M	7.65.M			7.66.M	7.66.M	7.66.M			7.67.M	7.67.M	7.67.M			7.68.M	7.68.M	7.68.M			7.69.M	7.69.M	7.69.M			7.70.M	7.70.M	7.70.M			7.71.M	7.71.M	7.71.M			7.72.M	7.72.M	7.72.M			7.73.M	7.73.M	7.73.M			7.74.M	7.74.M	7.74.M			7.75.M	7.75.M	7.75.M			7.76.M	7.76.M	7.76.M			7.77.M	7.77.M	7.77.M			7.78.M	7.78.M	7.78.M			7.79.M	7.79.M	7.79.M			7.80.M	7.80.M	7.80.M			7.81.M	7.81.M	7.81.M			7.82.M	7.82.M	7.82.M			7.83.M	7.83.M	7.83.M			7.84.M	7.84.M	7.84.M			7.85.M	7.85.M	7.85.M			7.86.M	7.86.M	7.86.M			7.87.M	7.87.M	7.87.M			7.88.M	7.88.M	7.88.M			7.89.M	7.89.M	7.89.M			7.90.M	7.90.M	7.90.M			7.91.M	7.91.M	7.91.M			7.92.M	7.92.M	7.92.M			7.93.M	7.93.M	7.93.M			7.94.M	7.94.M	7.94.M			7.95.M	7.95.M	7.95.M			7.96.M	7.96.M	7.96.M			7.97.M	7.97.M	7.97.M			7.98.M	7.98.M	7.98.M			7.99.M	7.99.M	7.99.M			7.100.M	7.100.M	7.100.M		<p>関連資料の相違          ・泊では、試験検査が可能な設計であることを示す関連する設計資料にて示している。</p>
備考	設備名	設備仕様	設備仕様	備考																																																																																																																																																																																																																																																																																																																																																																																																																																																																																																																		
	7.2.M	7.2.M	7.2.M																																																																																																																																																																																																																																																																																																																																																																																																																																																																																																																			
	7.3.M	7.3.M	7.3.M																																																																																																																																																																																																																																																																																																																																																																																																																																																																																																																			
	7.4.M	7.4.M	7.4.M																																																																																																																																																																																																																																																																																																																																																																																																																																																																																																																			
	7.5.M	7.5.M	7.5.M																																																																																																																																																																																																																																																																																																																																																																																																																																																																																																																			
	7.6.M	7.6.M	7.6.M																																																																																																																																																																																																																																																																																																																																																																																																																																																																																																																			
	7.7.M	7.7.M	7.7.M																																																																																																																																																																																																																																																																																																																																																																																																																																																																																																																			
	7.8.M	7.8.M	7.8.M																																																																																																																																																																																																																																																																																																																																																																																																																																																																																																																			
	7.9.M	7.9.M	7.9.M																																																																																																																																																																																																																																																																																																																																																																																																																																																																																																																			
	7.10.M	7.10.M	7.10.M																																																																																																																																																																																																																																																																																																																																																																																																																																																																																																																			
	7.11.M	7.11.M	7.11.M																																																																																																																																																																																																																																																																																																																																																																																																																																																																																																																			
	7.12.M	7.12.M	7.12.M																																																																																																																																																																																																																																																																																																																																																																																																																																																																																																																			
	7.13.M	7.13.M	7.13.M																																																																																																																																																																																																																																																																																																																																																																																																																																																																																																																			
	7.14.M	7.14.M	7.14.M																																																																																																																																																																																																																																																																																																																																																																																																																																																																																																																			
	7.15.M	7.15.M	7.15.M																																																																																																																																																																																																																																																																																																																																																																																																																																																																																																																			
	7.16.M	7.16.M	7.16.M																																																																																																																																																																																																																																																																																																																																																																																																																																																																																																																			
	7.17.M	7.17.M	7.17.M																																																																																																																																																																																																																																																																																																																																																																																																																																																																																																																			
	7.18.M	7.18.M	7.18.M																																																																																																																																																																																																																																																																																																																																																																																																																																																																																																																			
	7.19.M	7.19.M	7.19.M																																																																																																																																																																																																																																																																																																																																																																																																																																																																																																																			
	7.20.M	7.20.M	7.20.M																																																																																																																																																																																																																																																																																																																																																																																																																																																																																																																			
	7.21.M	7.21.M	7.21.M																																																																																																																																																																																																																																																																																																																																																																																																																																																																																																																			
	7.22.M	7.22.M	7.22.M																																																																																																																																																																																																																																																																																																																																																																																																																																																																																																																			
	7.23.M	7.23.M	7.23.M																																																																																																																																																																																																																																																																																																																																																																																																																																																																																																																			
	7.24.M	7.24.M	7.24.M																																																																																																																																																																																																																																																																																																																																																																																																																																																																																																																			
	7.25.M	7.25.M	7.25.M																																																																																																																																																																																																																																																																																																																																																																																																																																																																																																																			
	7.26.M	7.26.M	7.26.M																																																																																																																																																																																																																																																																																																																																																																																																																																																																																																																			
	7.27.M	7.27.M	7.27.M																																																																																																																																																																																																																																																																																																																																																																																																																																																																																																																			
	7.28.M	7.28.M	7.28.M																																																																																																																																																																																																																																																																																																																																																																																																																																																																																																																			
	7.29.M	7.29.M	7.29.M																																																																																																																																																																																																																																																																																																																																																																																																																																																																																																																			
	7.30.M	7.30.M	7.30.M																																																																																																																																																																																																																																																																																																																																																																																																																																																																																																																			
	7.31.M	7.31.M	7.31.M																																																																																																																																																																																																																																																																																																																																																																																																																																																																																																																			
	7.32.M	7.32.M	7.32.M																																																																																																																																																																																																																																																																																																																																																																																																																																																																																																																			
	7.33.M	7.33.M	7.33.M																																																																																																																																																																																																																																																																																																																																																																																																																																																																																																																			
	7.34.M	7.34.M	7.34.M																																																																																																																																																																																																																																																																																																																																																																																																																																																																																																																			
	7.35.M	7.35.M	7.35.M																																																																																																																																																																																																																																																																																																																																																																																																																																																																																																																			
	7.36.M	7.36.M	7.36.M																																																																																																																																																																																																																																																																																																																																																																																																																																																																																																																			
	7.37.M	7.37.M	7.37.M																																																																																																																																																																																																																																																																																																																																																																																																																																																																																																																			
	7.38.M	7.38.M	7.38.M																																																																																																																																																																																																																																																																																																																																																																																																																																																																																																																			
	7.39.M	7.39.M	7.39.M																																																																																																																																																																																																																																																																																																																																																																																																																																																																																																																			
	7.40.M	7.40.M	7.40.M																																																																																																																																																																																																																																																																																																																																																																																																																																																																																																																			
	7.41.M	7.41.M	7.41.M																																																																																																																																																																																																																																																																																																																																																																																																																																																																																																																			
	7.42.M	7.42.M	7.42.M																																																																																																																																																																																																																																																																																																																																																																																																																																																																																																																			
	7.43.M	7.43.M	7.43.M																																																																																																																																																																																																																																																																																																																																																																																																																																																																																																																			
	7.44.M	7.44.M	7.44.M																																																																																																																																																																																																																																																																																																																																																																																																																																																																																																																			
	7.45.M	7.45.M	7.45.M																																																																																																																																																																																																																																																																																																																																																																																																																																																																																																																			
	7.46.M	7.46.M	7.46.M																																																																																																																																																																																																																																																																																																																																																																																																																																																																																																																			
	7.47.M	7.47.M	7.47.M																																																																																																																																																																																																																																																																																																																																																																																																																																																																																																																			
	7.48.M	7.48.M	7.48.M																																																																																																																																																																																																																																																																																																																																																																																																																																																																																																																			
	7.49.M	7.49.M	7.49.M																																																																																																																																																																																																																																																																																																																																																																																																																																																																																																																			
	7.50.M	7.50.M	7.50.M																																																																																																																																																																																																																																																																																																																																																																																																																																																																																																																			
	7.51.M	7.51.M	7.51.M																																																																																																																																																																																																																																																																																																																																																																																																																																																																																																																			
	7.52.M	7.52.M	7.52.M																																																																																																																																																																																																																																																																																																																																																																																																																																																																																																																			
	7.53.M	7.53.M	7.53.M																																																																																																																																																																																																																																																																																																																																																																																																																																																																																																																			
	7.54.M	7.54.M	7.54.M																																																																																																																																																																																																																																																																																																																																																																																																																																																																																																																			
	7.55.M	7.55.M	7.55.M																																																																																																																																																																																																																																																																																																																																																																																																																																																																																																																			
	7.56.M	7.56.M	7.56.M																																																																																																																																																																																																																																																																																																																																																																																																																																																																																																																			
	7.57.M	7.57.M	7.57.M																																																																																																																																																																																																																																																																																																																																																																																																																																																																																																																			
	7.58.M	7.58.M	7.58.M																																																																																																																																																																																																																																																																																																																																																																																																																																																																																																																			
	7.59.M	7.59.M	7.59.M																																																																																																																																																																																																																																																																																																																																																																																																																																																																																																																			
	7.60.M	7.60.M	7.60.M																																																																																																																																																																																																																																																																																																																																																																																																																																																																																																																			
	7.61.M	7.61.M	7.61.M																																																																																																																																																																																																																																																																																																																																																																																																																																																																																																																			
	7.62.M	7.62.M	7.62.M																																																																																																																																																																																																																																																																																																																																																																																																																																																																																																																			
	7.63.M	7.63.M	7.63.M																																																																																																																																																																																																																																																																																																																																																																																																																																																																																																																			
	7.64.M	7.64.M	7.64.M																																																																																																																																																																																																																																																																																																																																																																																																																																																																																																																			
	7.65.M	7.65.M	7.65.M																																																																																																																																																																																																																																																																																																																																																																																																																																																																																																																			
	7.66.M	7.66.M	7.66.M																																																																																																																																																																																																																																																																																																																																																																																																																																																																																																																			
	7.67.M	7.67.M	7.67.M																																																																																																																																																																																																																																																																																																																																																																																																																																																																																																																			
	7.68.M	7.68.M	7.68.M																																																																																																																																																																																																																																																																																																																																																																																																																																																																																																																			
	7.69.M	7.69.M	7.69.M																																																																																																																																																																																																																																																																																																																																																																																																																																																																																																																			
	7.70.M	7.70.M	7.70.M																																																																																																																																																																																																																																																																																																																																																																																																																																																																																																																			
	7.71.M	7.71.M	7.71.M																																																																																																																																																																																																																																																																																																																																																																																																																																																																																																																			
	7.72.M	7.72.M	7.72.M																																																																																																																																																																																																																																																																																																																																																																																																																																																																																																																			
	7.73.M	7.73.M	7.73.M																																																																																																																																																																																																																																																																																																																																																																																																																																																																																																																			
	7.74.M	7.74.M	7.74.M																																																																																																																																																																																																																																																																																																																																																																																																																																																																																																																			
	7.75.M	7.75.M	7.75.M																																																																																																																																																																																																																																																																																																																																																																																																																																																																																																																			
	7.76.M	7.76.M	7.76.M																																																																																																																																																																																																																																																																																																																																																																																																																																																																																																																			
	7.77.M	7.77.M	7.77.M																																																																																																																																																																																																																																																																																																																																																																																																																																																																																																																			
	7.78.M	7.78.M	7.78.M																																																																																																																																																																																																																																																																																																																																																																																																																																																																																																																			
	7.79.M	7.79.M	7.79.M																																																																																																																																																																																																																																																																																																																																																																																																																																																																																																																			
	7.80.M	7.80.M	7.80.M																																																																																																																																																																																																																																																																																																																																																																																																																																																																																																																			
	7.81.M	7.81.M	7.81.M																																																																																																																																																																																																																																																																																																																																																																																																																																																																																																																			
	7.82.M	7.82.M	7.82.M																																																																																																																																																																																																																																																																																																																																																																																																																																																																																																																			
	7.83.M	7.83.M	7.83.M																																																																																																																																																																																																																																																																																																																																																																																																																																																																																																																			
	7.84.M	7.84.M	7.84.M																																																																																																																																																																																																																																																																																																																																																																																																																																																																																																																			
	7.85.M	7.85.M	7.85.M																																																																																																																																																																																																																																																																																																																																																																																																																																																																																																																			
	7.86.M	7.86.M	7.86.M																																																																																																																																																																																																																																																																																																																																																																																																																																																																																																																			
	7.87.M	7.87.M	7.87.M																																																																																																																																																																																																																																																																																																																																																																																																																																																																																																																			
	7.88.M	7.88.M	7.88.M																																																																																																																																																																																																																																																																																																																																																																																																																																																																																																																			
	7.89.M	7.89.M	7.89.M																																																																																																																																																																																																																																																																																																																																																																																																																																																																																																																			
	7.90.M	7.90.M	7.90.M																																																																																																																																																																																																																																																																																																																																																																																																																																																																																																																			
	7.91.M	7.91.M	7.91.M																																																																																																																																																																																																																																																																																																																																																																																																																																																																																																																			
	7.92.M	7.92.M	7.92.M																																																																																																																																																																																																																																																																																																																																																																																																																																																																																																																			
	7.93.M	7.93.M	7.93.M																																																																																																																																																																																																																																																																																																																																																																																																																																																																																																																			
	7.94.M	7.94.M	7.94.M																																																																																																																																																																																																																																																																																																																																																																																																																																																																																																																			
	7.95.M	7.95.M	7.95.M																																																																																																																																																																																																																																																																																																																																																																																																																																																																																																																			
	7.96.M	7.96.M	7.96.M																																																																																																																																																																																																																																																																																																																																																																																																																																																																																																																			
	7.97.M	7.97.M	7.97.M																																																																																																																																																																																																																																																																																																																																																																																																																																																																																																																			
	7.98.M	7.98.M	7.98.M																																																																																																																																																																																																																																																																																																																																																																																																																																																																																																																			
	7.99.M	7.99.M	7.99.M																																																																																																																																																																																																																																																																																																																																																																																																																																																																																																																			
	7.100.M	7.100.M	7.100.M																																																																																																																																																																																																																																																																																																																																																																																																																																																																																																																			

赤字：設備、運用又は体制の相違（設計方針の相違）  
 青字：記載箇所又は記載内容の相違（記載方針の相違）  
 緑字：記載表現、設備名称の相違（実質的な相違なし）

大飯発電所 3 / 4 号炉	泊発電所 3 号炉	相違理由
	<div data-bbox="1137 277 1872 1315" style="border: 2px solid black; width: 100%; height: 100%;"></div> <div data-bbox="1256 1321 1704 1347" style="text-align: center; margin-top: 10px;"> <span style="border: 1px solid black; display: inline-block; width: 15px; height: 10px;"></span> 枠囲みの内容は機密情報に属しますので公開できません。                 </div>	<p>関連資料の相違</p> <ul style="list-style-type: none"> <li>・泊では、試験検査が可能な設計であることを示す関連する設計資料にて示している。</li> </ul>

泊発電所3号炉 SA基準適合性 比較表

赤字：設備、運用又は体制の相違（設計方針の相違）  
 青字：記載箇所又は記載内容の相違（記載方針の相違）  
 緑字：記載表現、設備名称の相違（実質的な相違なし）

第50条 原子炉格納容器の過圧破損を防止するための設備

大飯発電所3/4号炉	泊発電所3号炉	相違理由
	<div data-bbox="1140 277 1872 1315" style="border: 2px solid black; width: 100%; height: 100%;"></div> <div data-bbox="1258 1331 1704 1353" style="text-align: center; margin-top: 10px;"> <span style="border: 1px solid black; display: inline-block; width: 15px; height: 10px;"></span> 枠囲みの内容は機密情報に属しますので公開できません。                 </div>	<p>関連資料の相違                      ・泊では、試験検査が可能な設計であることを示す関連する設計資料にて示している。</p>

赤字：設備、運用又は体制の相違（設計方針の相違）  
 青字：記載箇所又は記載内容の相違（記載方針の相違）  
 緑字：記載表現、設備名称の相違（実質的な相違なし）

第50条 原子炉格納容器の過圧破損を防止するための設備

大飯発電所3/4号炉	泊発電所3号炉	相違理由
<div data-bbox="188 197 1012 1366" style="border: 2px solid black; height: 732px; width: 368px;"></div> <div data-bbox="188 1366 703 1394" style="border: 1px solid black; padding: 2px;">                     枠囲みの範囲は機密に係る事項ですので公開することはできません。                 </div>	<div data-bbox="1146 280 1877 1315" style="border: 2px solid black; height: 648px; width: 326px;"></div> <div data-bbox="1258 1334 1706 1356" style="border: 1px solid black; padding: 2px;">                     枠囲みの内容は機密情報に属しますので公開できません。                 </div>	



赤字：設備、運用又は体制の相違（設計方針の相違）  
 青字：記載箇所又は記載内容の相違（記載方針の相違）  
 緑字：記載表現、設備名称の相違（実質的な相違なし）

第50条 原子炉格納容器の過圧破損を防止するための設備

大飯発電所3 / 4号炉	泊発電所3号炉	相違理由
<div data-bbox="181 197 1008 1366" style="border: 2px solid black; height: 732px; width: 369px;"></div> <div data-bbox="181 1366 698 1390" style="border: 1px solid black; padding: 2px;">                     枠囲みの範囲は機密に係る事項ですので公開することはできません。                 </div>	<div data-bbox="1144 277 1874 1315" style="border: 2px solid black; height: 650px; width: 326px;"></div> <div data-bbox="1261 1329 1704 1353" style="border: 1px solid black; padding: 2px;">                     枠囲みの内容は機密情報に属しますので公開できません。                 </div>	

第50条 原子炉格納容器の過圧破損を防止するための設備

赤字：設備、運用又は体制の相違（設計方針の相違）  
 青字：記載箇所又は記載内容の相違（記載方針の相違）  
 緑字：記載表現、設備名称の相違（実質的な相違なし）

大飯発電所3/4号炉		泊発電所3号炉		相違理由
機器又は系統名	放射性(機器名)	危険及び試験の項目	保全方式又は程度	検査名
原子炉格納容器 [原子炉格納容器] その他の井	放射性格納容器(換気設備) その他の井	1. 運転・性能試験 2. 分解点検 3. 緊急点検 (クランパバネン取替) 1. 運転・性能試験 2. 分解点検 3. 緊急点検 (特性点検) 1. 分解点検 2. 分解点検 3. 緊急点検 (潮水浸入)	B 130M 130M B 182M~130M 130M 13M 3F 5Y 5Y 2/3F 52M 26M 2/3F 52M 26M 2/3F 10Y 2/3F 1F	1次系安全弁検査 1次系弁検査 1次系弁検査 A-D格納容器再循環ユニット 有初性評価No. 4の点検 一部実行要迄 一部実行要迄
原子炉格納容器 [原子炉格納容器]	原子炉格納容器	1. 運転・性能試験 (潮水浸入)	高・圧 13M~130M	原子炉格納容器全体漏えい試験10年に1回は設計圧力にて実施
原子炉格納容器 [原子炉格納容器]	原子炉格納容器	1. 運転・性能試験	高・圧 13M	プレストレストコンクリート格納容器 密封閉鎖中検査 プレストレストコンクリート格納容器 密封閉鎖中検査 原子炉格納容器漏えい試験
原子炉格納容器 [原子炉格納容器]	原子炉格納容器	1. 運転・性能試験	高・圧 3F	原子炉格納容器漏えい試験
原子炉格納容器 [原子炉格納容器]	原子炉格納容器	1. 運転・性能試験	高・圧 5Y	原子炉格納容器漏えい試験
原子炉格納容器 [原子炉格納容器]	原子炉格納容器	1. 運転・性能試験	高・圧 2/3F	原子炉格納容器漏えい試験
原子炉格納容器 [原子炉格納容器]	原子炉格納容器	1. 運転・性能試験	高・圧 52M	原子炉格納容器漏えい試験
原子炉格納容器 [原子炉格納容器]	原子炉格納容器	1. 運転・性能試験	高・圧 26M	原子炉格納容器漏えい試験
原子炉格納容器 [原子炉格納容器]	原子炉格納容器	1. 運転・性能試験	高・圧 2/3F	原子炉格納容器漏えい試験
原子炉格納容器 [原子炉格納容器]	原子炉格納容器	1. 運転・性能試験	高・圧 52M	原子炉格納容器漏えい試験
原子炉格納容器 [原子炉格納容器]	原子炉格納容器	1. 運転・性能試験	高・圧 26M	原子炉格納容器漏えい試験
原子炉格納容器 [原子炉格納容器]	原子炉格納容器	1. 運転・性能試験	高・圧 2/3F	原子炉格納容器漏えい試験
原子炉格納容器 [原子炉格納容器]	原子炉格納容器	1. 運転・性能試験	高・圧 10Y	原子炉格納容器漏えい試験
原子炉格納容器 [原子炉格納容器]	原子炉格納容器	1. 運転・性能試験	高・圧 2/3F	原子炉格納容器漏えい試験
原子炉格納容器 [原子炉格納容器]	原子炉格納容器	1. 運転・性能試験	高・圧 1F	原子炉格納容器漏えい試験

別紙-1 (H-30)

機器又は系統名	放射性(機器名)	危険及び試験の項目	保全方式又は程度	検査名
原子炉格納容器 [原子炉格納容器]	放射性格納容器(換気設備) その他の井	1. 運転・性能試験 2. 分解点検 3. 緊急点検 (クランパバネン取替) 1. 運転・性能試験 2. 分解点検 3. 緊急点検 (特性点検) 1. 分解点検 2. 分解点検 3. 緊急点検 (潮水浸入)	B 130M 130M B 182M~130M 130M 13M 3F 5Y 5Y 2/3F 52M 26M 2/3F 52M 26M 2/3F 10Y 2/3F 1F	1次系安全弁検査 1次系弁検査 1次系弁検査 A-D格納容器再循環ユニット 有初性評価No. 4の点検 一部実行要迄 一部実行要迄
原子炉格納容器 [原子炉格納容器]	原子炉格納容器	1. 運転・性能試験 (潮水浸入)	高・圧 13M~130M	原子炉格納容器全体漏えい試験10年に1回は設計圧力にて実施
原子炉格納容器 [原子炉格納容器]	原子炉格納容器	1. 運転・性能試験	高・圧 13M	プレストレストコンクリート格納容器 密封閉鎖中検査 プレストレストコンクリート格納容器 密封閉鎖中検査 原子炉格納容器漏えい試験
原子炉格納容器 [原子炉格納容器]	原子炉格納容器	1. 運転・性能試験	高・圧 3F	原子炉格納容器漏えい試験
原子炉格納容器 [原子炉格納容器]	原子炉格納容器	1. 運転・性能試験	高・圧 5Y	原子炉格納容器漏えい試験
原子炉格納容器 [原子炉格納容器]	原子炉格納容器	1. 運転・性能試験	高・圧 2/3F	原子炉格納容器漏えい試験
原子炉格納容器 [原子炉格納容器]	原子炉格納容器	1. 運転・性能試験	高・圧 52M	原子炉格納容器漏えい試験
原子炉格納容器 [原子炉格納容器]	原子炉格納容器	1. 運転・性能試験	高・圧 26M	原子炉格納容器漏えい試験
原子炉格納容器 [原子炉格納容器]	原子炉格納容器	1. 運転・性能試験	高・圧 2/3F	原子炉格納容器漏えい試験
原子炉格納容器 [原子炉格納容器]	原子炉格納容器	1. 運転・性能試験	高・圧 52M	原子炉格納容器漏えい試験
原子炉格納容器 [原子炉格納容器]	原子炉格納容器	1. 運転・性能試験	高・圧 26M	原子炉格納容器漏えい試験
原子炉格納容器 [原子炉格納容器]	原子炉格納容器	1. 運転・性能試験	高・圧 2/3F	原子炉格納容器漏えい試験
原子炉格納容器 [原子炉格納容器]	原子炉格納容器	1. 運転・性能試験	高・圧 10Y	原子炉格納容器漏えい試験
原子炉格納容器 [原子炉格納容器]	原子炉格納容器	1. 運転・性能試験	高・圧 2/3F	原子炉格納容器漏えい試験
原子炉格納容器 [原子炉格納容器]	原子炉格納容器	1. 運転・性能試験	高・圧 1F	原子炉格納容器漏えい試験

別紙-1 (H-30)

別紙-12

赤字：設備、運用又は体制の相違（設計方針の相違）  
 青字：記載箇所又は記載内容の相違（記載方針の相違）  
 緑字：記載表現、設備名称の相違（実質的な相違なし）

第50条 原子炉格納容器の過圧破損を防止するための設備

大飯発電所3/4号炉	泊発電所3号炉	相違理由
<div data-bbox="183 201 1012 1362" style="border: 2px solid black; height: 728px; width: 370px; margin: 10px auto;"></div> <div data-bbox="183 1366 564 1385" style="border: 1px solid black; padding: 2px; width: fit-content; margin-top: 5px;">                     枠囲みの範囲は機密に係る事項ですので公開することはできません。                 </div>	<div data-bbox="1146 277 1868 1311" style="border: 2px solid black; height: 648px; width: 322px; margin: 10px auto;"></div> <div data-bbox="1258 1334 1706 1353" style="border: 1px solid black; padding: 2px; width: fit-content; margin-top: 5px;">                     枠囲みの内容は機密情報に属しますので公開できません。                 </div>	

赤字：設備、運用又は体制の相違（設計方針の相違）  
 青字：記載箇所又は記載内容の相違（記載方針の相違）  
 緑字：記載表現、設備名称の相違（実質的な相違なし）

第50条 原子炉格納容器の過圧破損を防止するための設備

大飯発電所3/4号炉	泊発電所3号炉	相違理由
<div data-bbox="185 204 1010 1374" style="border: 2px solid black; height: 733px; width: 368px; margin: 10px auto;"></div> <div data-bbox="185 1369 703 1396" style="border: 1px solid black; padding: 2px; width: fit-content;">                     枠囲みの範囲は機密に係る事項ですので公開することできません。                 </div>	<div data-bbox="1146 284 1874 1310" style="border: 2px solid black; height: 643px; width: 325px; margin: 10px auto;"></div> <div data-bbox="1258 1332 1704 1356" style="border: 1px solid black; padding: 2px; width: fit-content; margin: 10px auto;">                     枠囲みの内容は機密情報に属しますので公開できません。                 </div>	

赤字：設備、運用又は体制の相違（設計方針の相違）  
 青字：記載箇所又は記載内容の相違（記載方針の相違）  
 緑字：記載表現、設備名称の相違（実質的な相違なし）

第50条 原子炉格納容器の過圧破損を防止するための設備

大飯発電所3 / 4号炉	泊発電所3号炉	相違理由
<div data-bbox="188 197 1014 1366" style="border: 2px solid black; height: 732px; width: 369px; margin: 10px auto;"></div> <div data-bbox="188 1366 703 1394" style="border: 1px solid black; padding: 2px; margin-top: 5px;">                     枠囲みの範囲は機密に係る事項ですので公開することはできません。                 </div>		<p>SA手段の相違</p> <ul style="list-style-type: none"> <li>・大飯では、可搬型ポンプ（可搬式代替低圧注水ポンプ等）を使った代替炉心注水において、仮設組立式水槽を使用する</li> <li>・泊では可搬型大型送水ポンプ車により水源から直接給水が可能のため、仮設組立式水槽は使用しないため比較対象資料なし。</li> </ul>

赤字：設備、運用又は体制の相違（設計方針の相違）  
 青字：記載箇所又は記載内容の相違（記載方針の相違）  
 緑字：記載表現、設備名称の相違（実質的な相違なし）

第50条 原子炉格納容器の過圧破損を防止するための設備

大飯発電所3/4号炉	泊発電所3号炉	相違理由
<div data-bbox="188 201 1014 1366" style="border: 2px solid black; height: 730px; width: 369px;"></div> <div data-bbox="188 1366 705 1393" style="border: 1px solid black; padding: 2px;">枠囲みの範囲は機密に係る事項ですので公開することはできません。</div>	<div data-bbox="1146 285 1868 1313" style="border: 2px solid black; height: 644px; width: 322px;"></div> <div data-bbox="1258 1329 1704 1350" style="border: 1px solid black; padding: 2px;">枠囲みの内容は機密情報に属しますので公開できません。</div>	

赤字：設備、運用又は体制の相違（設計方針の相違）  
 青字：記載箇所又は記載内容の相違（記載方針の相違）  
 緑字：記載表現、設備名称の相違（実質的な相違なし）

第50条 原子炉格納容器の過圧破損を防止するための設備

大飯発電所3 / 4号炉	泊発電所3号炉	相違理由
<div data-bbox="203 233 992 1347" style="border: 2px solid black; height: 698px; width: 352px; margin: 10px auto;"></div> <div data-bbox="360 1358 808 1385" style="border: 1px solid black; padding: 2px; width: fit-content; margin: 10px auto;">                     枠囲みの範囲は機密に係る事項ですので公開することはできません。                 </div>		<p>SA手段の相違</p> <ul style="list-style-type: none"> <li>・大飯では、仮設組立式水槽を水源として、可搬式代替低圧注水ポンプを使った代替炉心注水を行う。</li> <li>・泊では可搬型大型送水ポンプ車により水源から直接給水が可能のため、仮設組立式水槽・可搬式代替低圧注水ポンプは使用しないため比較対象資料なし。</li> </ul>

赤字：設備、運用又は体制の相違（設計方針の相違）  
 青字：記載箇所又は記載内容の相違（記載方針の相違）  
 緑字：記載表現、設備名称の相違（実質的な相違なし）

第50条 原子炉格納容器の過圧破損を防止するための設備

大飯発電所3/4号炉	泊発電所3号炉	相違理由
<div data-bbox="181 204 1003 1369" style="border: 2px solid black; height: 730px; width: 100%;"></div> <div data-bbox="181 1369 696 1401" style="border: 1px solid black; padding: 2px;">                     枠囲みの範囲は機密に係る事項ですので公開することはできません。                 </div>		SA手段の相違 ・大飯では、仮設組立式水槽を水源として、可搬式代替低圧注水ポンプを使った代替炉心注水を行う。 ・泊では可搬型大型送水ポンプ車により水源から直接給水が可能のため、仮設組立式水槽・可搬式代替低圧注水ポンプは使用しないため比較対象資料なし。



赤字：設備、運用又は体制の相違（設計方針の相違）  
 青字：記載箇所又は記載内容の相違（記載方針の相違）  
 緑字：記載表現、設備名称の相違（実質的な相違なし）

第50条 原子炉格納容器の過圧破損を防止するための設備

大飯発電所3 / 4号炉	泊発電所3号炉	相違理由
<div data-bbox="185 201 1014 1369" style="border: 2px solid black; height: 732px; width: 370px; margin: 10px auto;"></div> <div data-bbox="185 1369 705 1396" style="border: 1px solid black; padding: 2px; margin-top: 5px;">                     枠囲みの範囲は機密に係る事項ですので公開することはできません。                 </div>		<p>SA 手段の相違</p> <ul style="list-style-type: none"> <li>・大飯では、仮設組立式水槽を水源として、可搬式代替低圧注水ポンプを使った代替炉心注水を行い、専用の可搬型電源を使用する。</li> <li>・泊では可搬型大型送水ポンプ車により水源から直接給水が可能のため、仮設組立式水槽・可搬式代替低圧注水ポンプは使用せず、可搬型ポンプ車は車両ディーゼルエンジンにて駆動することから、比較対象資料なし。</li> </ul>

赤字：設備、運用又は体制の相違（設計方針の相違）  
 青字：記載箇所又は記載内容の相違（記載方針の相違）  
 緑字：記載表現、設備名称の相違（実質的な相違なし）

第50条 原子炉格納容器の過圧破損を防止するための設備

大飯発電所3/4号炉	泊発電所3号炉	相違理由
<div data-bbox="185 199 1010 1364" style="border: 2px solid black; height: 730px; width: 368px; margin: 10px auto;"></div> <div data-bbox="185 1369 703 1396" style="border: 1px solid black; padding: 2px; margin-top: 5px;">                     枠囲みの範囲は機密に係る事項ですので公開することはできません。                 </div>		<p>SA手段の相違</p> <ul style="list-style-type: none"> <li>・大飯では、仮設組立式水槽を水源として、可搬式代替低圧注水ポンプを使った代替炉心注水を行い、専用の可搬型電源を使用する。</li> <li>・泊では可搬型大型送水ポンプ車により水源から直接給水が可能のため、仮設組立式水槽・可搬式代替低圧注水ポンプは使用せず、可搬型ポンプ車は車両ディーゼルエンジンにて駆動することから、比較対象資料なし。</li> </ul>

赤字：設備、運用又は体制の相違（設計方針の相違）  
 青字：記載箇所又は記載内容の相違（記載方針の相違）  
 緑字：記載表現、設備名称の相違（実質的な相違なし）

第50条 原子炉格納容器の過圧破損を防止するための設備

大飯発電所3 / 4号炉	泊発電所3号炉	相違理由
<div data-bbox="183 197 1010 1362" style="border: 2px solid black; height: 730px; width: 369px;"></div> <div data-bbox="183 1362 703 1390" style="border: 1px solid black; padding: 2px;">                     枠囲みの範囲は機密に係る事項ですので公開することはできません。                 </div>		<p>SA手段の相違</p> <ul style="list-style-type: none"> <li>・大飯では、仮設組立式水槽を水源として、可搬式代替低圧注水ポンプを使った代替炉心注水を行い、専用の可搬型電源を使用する。</li> <li>・泊では可搬型大型送水ポンプ車により水源から直接給水が可能のため、仮設組立式水槽・可搬式代替低圧注水ポンプは使用せず、可搬型ポンプ車は車両ディーゼルエンジンにて駆動することから、比較対象資料なし。</li> </ul>

赤字：設備、運用又は体制の相違（設計方針の相違）  
 青字：記載箇所又は記載内容の相違（記載方針の相違）  
 緑字：記載表現、設備名称の相違（実質的な相違なし）

第50条 原子炉格納容器の過圧破損を防止するための設備

大飯発電所3/4号炉	泊発電所3号炉	相違理由
<div data-bbox="183 201 1008 1369" style="border: 2px solid black; height: 732px; width: 368px; margin: 10px auto;"></div> <div data-bbox="183 1369 698 1398" style="border: 1px solid black; padding: 2px; margin-top: 5px;">                     枠囲みの範囲は機密に係る事項ですので公開することはできません。                 </div>		<p>SA手段の相違</p> <ul style="list-style-type: none"> <li>・大飯では、仮設組立式水槽を水源として、可搬式代替低圧注水ポンプを使った代替炉心注水を行い、専用の可搬型電源を使用する。</li> <li>・泊では可搬型大型送水ポンプ車により水源から直接給水が可能のため、仮設組立式水槽・可搬式代替低圧注水ポンプは使用せず、可搬型ポンプ車は車両ディーゼルエンジンにて駆動することから、比較対象資料なし。</li> </ul>

赤字：設備、運用又は体制の相違（設計方針の相違）  
 青字：記載箇所又は記載内容の相違（記載方針の相違）  
 緑字：記載表現、設備名称の相違（実質的な相違なし）

第50条 原子炉格納容器の過圧破損を防止するための設備

大飯発電所3/4号炉	泊発電所3号炉	相違理由
<div data-bbox="188 197 1010 1362" style="border: 2px solid black; height: 730px; width: 367px;"></div> <div data-bbox="188 1362 703 1390" style="border: 1px solid black; padding: 2px;">                     枠囲みの範囲は機密に係る事項ですので公開することはできません。                 </div>		<p>SA手段の相違</p> <ul style="list-style-type: none"> <li>・大飯では、仮設組立式水槽を水源として、可搬式代替母注水ポンプを使った代替炉心注水を行う。</li> <li>・泊では可搬型大型送水ポンプ車により水源から直接給水が可能のため、仮設組立式水槽・可搬式代替母注水ポンプは使用しないため比較対象資料なし。</li> </ul>

泊発電所3号炉 SA基準適合性 比較表

赤字：設備、運用又は体制の相違（設計方針の相違）  
 青字：記載箇所又は記載内容の相違（記載方針の相違）  
 緑字：記載表現、設備名称の相違（実質的な相違なし）

第50条 原子炉格納容器の過圧破損を防止するための設備

大飯発電所3/4号炉	泊発電所3号炉	相違理由
<p>50-5 系統図</p>	<p>50-4 系統図</p>	

赤字：設備、運用又は体制の相違（設計方針の相違）  
 青字：記載箇所又は記載内容の相違（記載方針の相違）  
 緑字：記載表現、設備名称の相違（実質的な相違なし）

第50条 原子炉格納容器の過圧破損を防止するための設備

大飯発電所3/4号炉	泊発電所3号炉	相違理由																																																																																																																																																
	<table border="1"> <thead> <tr> <th>No</th> <th>機器名称</th> <th>状態の変化</th> <th>操作場所</th> <th>操作方法</th> <th>備考</th> </tr> </thead> <tbody> <tr> <td>①</td> <td>C-原子炉補機冷却海水ポンプ</td> <td>停止→起動</td> <td>中央制御室</td> <td>操作器操作</td> <td>うち1台使用</td> </tr> <tr> <td>②</td> <td>D-原子炉補機冷却海水ポンプ</td> <td>停止→起動</td> <td>中央制御室</td> <td>操作器操作</td> <td>交流電源</td> </tr> <tr> <td>③</td> <td>C-原子炉補機冷却水ポンプ</td> <td>停止→起動</td> <td>中央制御室</td> <td>操作器操作</td> <td>うち1台使用</td> </tr> <tr> <td>④</td> <td>D-原子炉補機冷却水ポンプ</td> <td>停止→起動</td> <td>中央制御室</td> <td>操作器操作</td> <td>交流電源</td> </tr> <tr> <td>⑥</td> <td>A-余熱除去冷却器補機冷却水出口弁</td> <td>全閉確認</td> <td>中央制御室</td> <td>操作器操作</td> <td>交流電源</td> </tr> <tr> <td>⑦</td> <td>B-余熱除去冷却器補機冷却水出口弁</td> <td>全閉確認</td> <td>中央制御室</td> <td>操作器操作</td> <td>交流電源</td> </tr> <tr> <td>⑧</td> <td>A-格納容器スプレイ冷却器補機冷却水出口弁</td> <td>全閉確認</td> <td>中央制御室</td> <td>操作器操作</td> <td>交流電源</td> </tr> <tr> <td>⑨</td> <td>B-格納容器スプレイ冷却器補機冷却水出口弁</td> <td>全閉確認</td> <td>中央制御室</td> <td>操作器操作</td> <td>交流電源</td> </tr> <tr> <td>⑩</td> <td>原子炉補機冷却水サージタンクベント弁</td> <td>全閉確認</td> <td>中央制御室</td> <td>操作器操作</td> <td>直流電源 制御用空気</td> </tr> <tr> <td>⑩</td> <td>ホース</td> <td>ホース接続</td> <td>周辺補機棟 T.P.43.6m</td> <td>接続操作</td> <td>-</td> </tr> <tr> <td>⑪</td> <td>配管</td> <td>配管接続</td> <td>周辺補機棟 T.P.43.6m</td> <td>接続操作</td> <td>-</td> </tr> <tr> <td>⑫</td> <td>原子炉補機冷却水サージタンク加圧用可搬型窒素ガスボンベ口金弁1</td> <td>全閉→全開</td> <td>周辺補機棟 T.P.43.6m</td> <td>手動操作</td> <td>-</td> </tr> <tr> <td>⑬</td> <td>原子炉補機冷却水サージタンク加圧用可搬型窒素ガスボンベ口金弁2</td> <td>全閉→全開</td> <td>周辺補機棟 T.P.43.6m</td> <td>手動操作</td> <td>-</td> </tr> <tr> <td>⑭</td> <td>原子炉補機冷却水サージタンク加圧用窒素供給パネル入口弁1</td> <td>全閉→全開</td> <td>周辺補機棟 T.P.43.6m</td> <td>手動操作</td> <td>-</td> </tr> <tr> <td>⑮</td> <td>原子炉補機冷却水サージタンク加圧用窒素供給パネル入口弁2</td> <td>全閉→全開</td> <td>周辺補機棟 T.P.43.6m</td> <td>手動操作</td> <td>-</td> </tr> <tr> <td>⑯</td> <td>原子炉補機冷却水サージタンク加圧用窒素供給パネル減圧弁</td> <td>全閉→調整開</td> <td>周辺補機棟 T.P.43.6m</td> <td>手動操作</td> <td>-</td> </tr> <tr> <td>⑰</td> <td>原子炉補機冷却水サージタンク加圧用窒素供給パネル出口弁</td> <td>全閉→全開</td> <td>周辺補機棟 T.P.43.6m</td> <td>手動操作</td> <td>-</td> </tr> <tr> <td>⑱</td> <td>原子炉補機冷却水サージタンク薬品添加口第2止め弁</td> <td>全閉→全開</td> <td>周辺補機棟 T.P.43.6m</td> <td>手動操作</td> <td>-</td> </tr> <tr> <td>⑲</td> <td>原子炉補機冷却水サージタンク薬品添加口第1止め弁</td> <td>全閉→全開</td> <td>周辺補機棟 T.P.43.6m</td> <td>手動操作</td> <td>-</td> </tr> <tr> <td>⑳</td> <td>原子炉補機冷却水サージタンク可搬型圧力計接続用配管窒素供給止め弁</td> <td>全閉→調整開 →全開</td> <td>周辺補機棟 T.P.43.6m</td> <td>手動操作</td> <td>-</td> </tr> <tr> <td>㉑</td> <td>C、D-C/V再循環ユニット補機冷却水入口C/V外側隔離弁</td> <td>全閉→全開</td> <td>中央制御室</td> <td>操作器操作</td> <td>交流電源</td> </tr> <tr> <td>㉒</td> <td>C-C/V再循環ユニット補機冷却水出口C/V外側隔離弁</td> <td>全閉→全開</td> <td>中央制御室</td> <td>操作器操作</td> <td>交流電源</td> </tr> <tr> <td>㉓</td> <td>D-C/V再循環ユニット補機冷却水出口C/V外側隔離弁</td> <td>全閉→全開</td> <td>中央制御室</td> <td>操作器操作</td> <td>交流電源</td> </tr> </tbody> </table>	No	機器名称	状態の変化	操作場所	操作方法	備考	①	C-原子炉補機冷却海水ポンプ	停止→起動	中央制御室	操作器操作	うち1台使用	②	D-原子炉補機冷却海水ポンプ	停止→起動	中央制御室	操作器操作	交流電源	③	C-原子炉補機冷却水ポンプ	停止→起動	中央制御室	操作器操作	うち1台使用	④	D-原子炉補機冷却水ポンプ	停止→起動	中央制御室	操作器操作	交流電源	⑥	A-余熱除去冷却器補機冷却水出口弁	全閉確認	中央制御室	操作器操作	交流電源	⑦	B-余熱除去冷却器補機冷却水出口弁	全閉確認	中央制御室	操作器操作	交流電源	⑧	A-格納容器スプレイ冷却器補機冷却水出口弁	全閉確認	中央制御室	操作器操作	交流電源	⑨	B-格納容器スプレイ冷却器補機冷却水出口弁	全閉確認	中央制御室	操作器操作	交流電源	⑩	原子炉補機冷却水サージタンクベント弁	全閉確認	中央制御室	操作器操作	直流電源 制御用空気	⑩	ホース	ホース接続	周辺補機棟 T.P.43.6m	接続操作	-	⑪	配管	配管接続	周辺補機棟 T.P.43.6m	接続操作	-	⑫	原子炉補機冷却水サージタンク加圧用可搬型窒素ガスボンベ口金弁1	全閉→全開	周辺補機棟 T.P.43.6m	手動操作	-	⑬	原子炉補機冷却水サージタンク加圧用可搬型窒素ガスボンベ口金弁2	全閉→全開	周辺補機棟 T.P.43.6m	手動操作	-	⑭	原子炉補機冷却水サージタンク加圧用窒素供給パネル入口弁1	全閉→全開	周辺補機棟 T.P.43.6m	手動操作	-	⑮	原子炉補機冷却水サージタンク加圧用窒素供給パネル入口弁2	全閉→全開	周辺補機棟 T.P.43.6m	手動操作	-	⑯	原子炉補機冷却水サージタンク加圧用窒素供給パネル減圧弁	全閉→調整開	周辺補機棟 T.P.43.6m	手動操作	-	⑰	原子炉補機冷却水サージタンク加圧用窒素供給パネル出口弁	全閉→全開	周辺補機棟 T.P.43.6m	手動操作	-	⑱	原子炉補機冷却水サージタンク薬品添加口第2止め弁	全閉→全開	周辺補機棟 T.P.43.6m	手動操作	-	⑲	原子炉補機冷却水サージタンク薬品添加口第1止め弁	全閉→全開	周辺補機棟 T.P.43.6m	手動操作	-	⑳	原子炉補機冷却水サージタンク可搬型圧力計接続用配管窒素供給止め弁	全閉→調整開 →全開	周辺補機棟 T.P.43.6m	手動操作	-	㉑	C、D-C/V再循環ユニット補機冷却水入口C/V外側隔離弁	全閉→全開	中央制御室	操作器操作	交流電源	㉒	C-C/V再循環ユニット補機冷却水出口C/V外側隔離弁	全閉→全開	中央制御室	操作器操作	交流電源	㉓	D-C/V再循環ユニット補機冷却水出口C/V外側隔離弁	全閉→全開	中央制御室	操作器操作	交流電源	
No	機器名称	状態の変化	操作場所	操作方法	備考																																																																																																																																													
①	C-原子炉補機冷却海水ポンプ	停止→起動	中央制御室	操作器操作	うち1台使用																																																																																																																																													
②	D-原子炉補機冷却海水ポンプ	停止→起動	中央制御室	操作器操作	交流電源																																																																																																																																													
③	C-原子炉補機冷却水ポンプ	停止→起動	中央制御室	操作器操作	うち1台使用																																																																																																																																													
④	D-原子炉補機冷却水ポンプ	停止→起動	中央制御室	操作器操作	交流電源																																																																																																																																													
⑥	A-余熱除去冷却器補機冷却水出口弁	全閉確認	中央制御室	操作器操作	交流電源																																																																																																																																													
⑦	B-余熱除去冷却器補機冷却水出口弁	全閉確認	中央制御室	操作器操作	交流電源																																																																																																																																													
⑧	A-格納容器スプレイ冷却器補機冷却水出口弁	全閉確認	中央制御室	操作器操作	交流電源																																																																																																																																													
⑨	B-格納容器スプレイ冷却器補機冷却水出口弁	全閉確認	中央制御室	操作器操作	交流電源																																																																																																																																													
⑩	原子炉補機冷却水サージタンクベント弁	全閉確認	中央制御室	操作器操作	直流電源 制御用空気																																																																																																																																													
⑩	ホース	ホース接続	周辺補機棟 T.P.43.6m	接続操作	-																																																																																																																																													
⑪	配管	配管接続	周辺補機棟 T.P.43.6m	接続操作	-																																																																																																																																													
⑫	原子炉補機冷却水サージタンク加圧用可搬型窒素ガスボンベ口金弁1	全閉→全開	周辺補機棟 T.P.43.6m	手動操作	-																																																																																																																																													
⑬	原子炉補機冷却水サージタンク加圧用可搬型窒素ガスボンベ口金弁2	全閉→全開	周辺補機棟 T.P.43.6m	手動操作	-																																																																																																																																													
⑭	原子炉補機冷却水サージタンク加圧用窒素供給パネル入口弁1	全閉→全開	周辺補機棟 T.P.43.6m	手動操作	-																																																																																																																																													
⑮	原子炉補機冷却水サージタンク加圧用窒素供給パネル入口弁2	全閉→全開	周辺補機棟 T.P.43.6m	手動操作	-																																																																																																																																													
⑯	原子炉補機冷却水サージタンク加圧用窒素供給パネル減圧弁	全閉→調整開	周辺補機棟 T.P.43.6m	手動操作	-																																																																																																																																													
⑰	原子炉補機冷却水サージタンク加圧用窒素供給パネル出口弁	全閉→全開	周辺補機棟 T.P.43.6m	手動操作	-																																																																																																																																													
⑱	原子炉補機冷却水サージタンク薬品添加口第2止め弁	全閉→全開	周辺補機棟 T.P.43.6m	手動操作	-																																																																																																																																													
⑲	原子炉補機冷却水サージタンク薬品添加口第1止め弁	全閉→全開	周辺補機棟 T.P.43.6m	手動操作	-																																																																																																																																													
⑳	原子炉補機冷却水サージタンク可搬型圧力計接続用配管窒素供給止め弁	全閉→調整開 →全開	周辺補機棟 T.P.43.6m	手動操作	-																																																																																																																																													
㉑	C、D-C/V再循環ユニット補機冷却水入口C/V外側隔離弁	全閉→全開	中央制御室	操作器操作	交流電源																																																																																																																																													
㉒	C-C/V再循環ユニット補機冷却水出口C/V外側隔離弁	全閉→全開	中央制御室	操作器操作	交流電源																																																																																																																																													
㉓	D-C/V再循環ユニット補機冷却水出口C/V外側隔離弁	全閉→全開	中央制御室	操作器操作	交流電源																																																																																																																																													

赤字：設備、運用又は体制の相違（設計方針の相違）  
 青字：記載箇所又は記載内容の相違（記載方針の相違）  
 緑字：記載表現、設備名称の相違（実質的な相違なし）

第50条 原子炉格納容器の過圧破損を防止するための設備

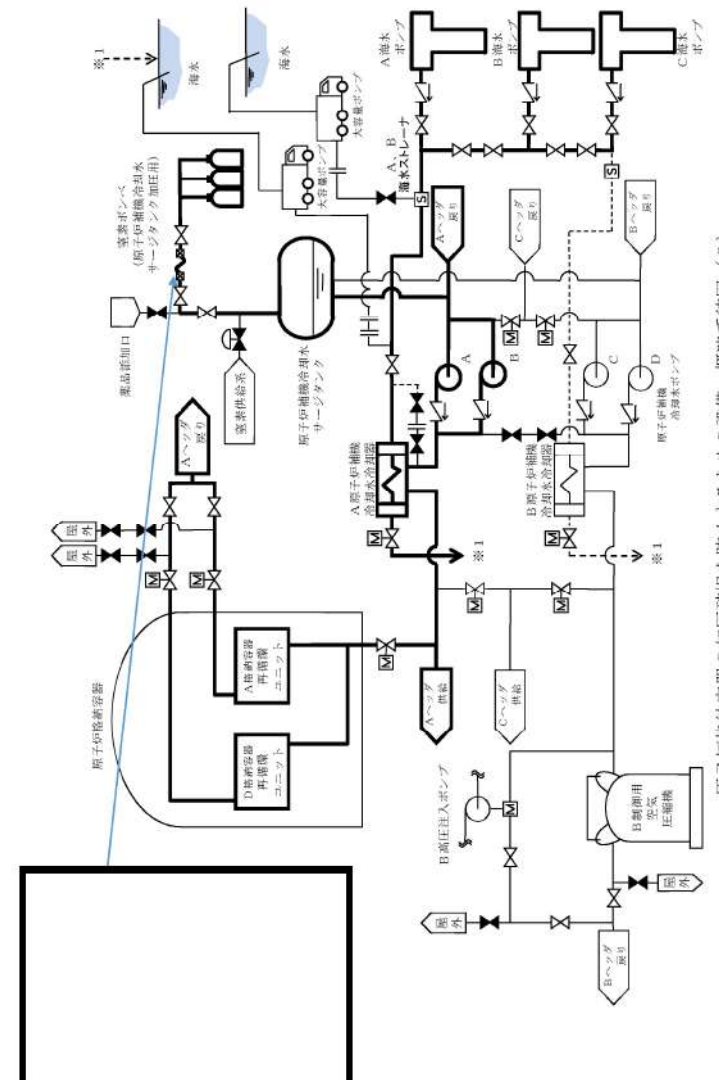
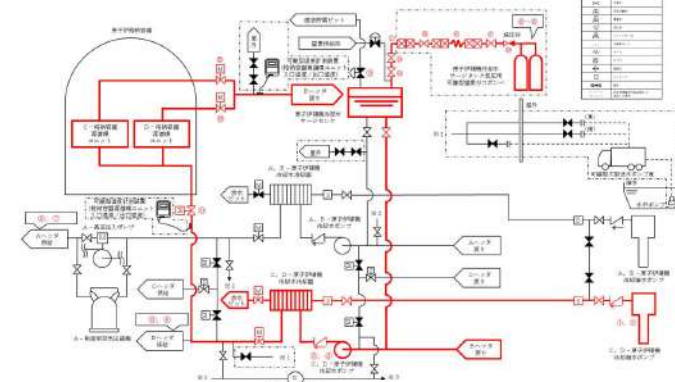
大飯発電所3/4号炉	泊発電所3号炉	相違理由
 <p>原子炉格納容器の過圧破損を防止するための設備 概略系統図(2)</p> <p>枠囲みの範囲は機密に係る事項ですので公開することはできません。</p>	 <p>図 50-4-1 C、D-格納容器再循環ユニットによる格納容器内自然対流冷却</p>	



赤字：設備、運用又は体制の相違（設計方針の相違）  
 青字：記載箇所又は記載内容の相違（記載方針の相違）  
 緑字：記載表現、設備名称の相違（実質的な相違なし）

第50条 原子炉格納容器の過圧破損を防止するための設備

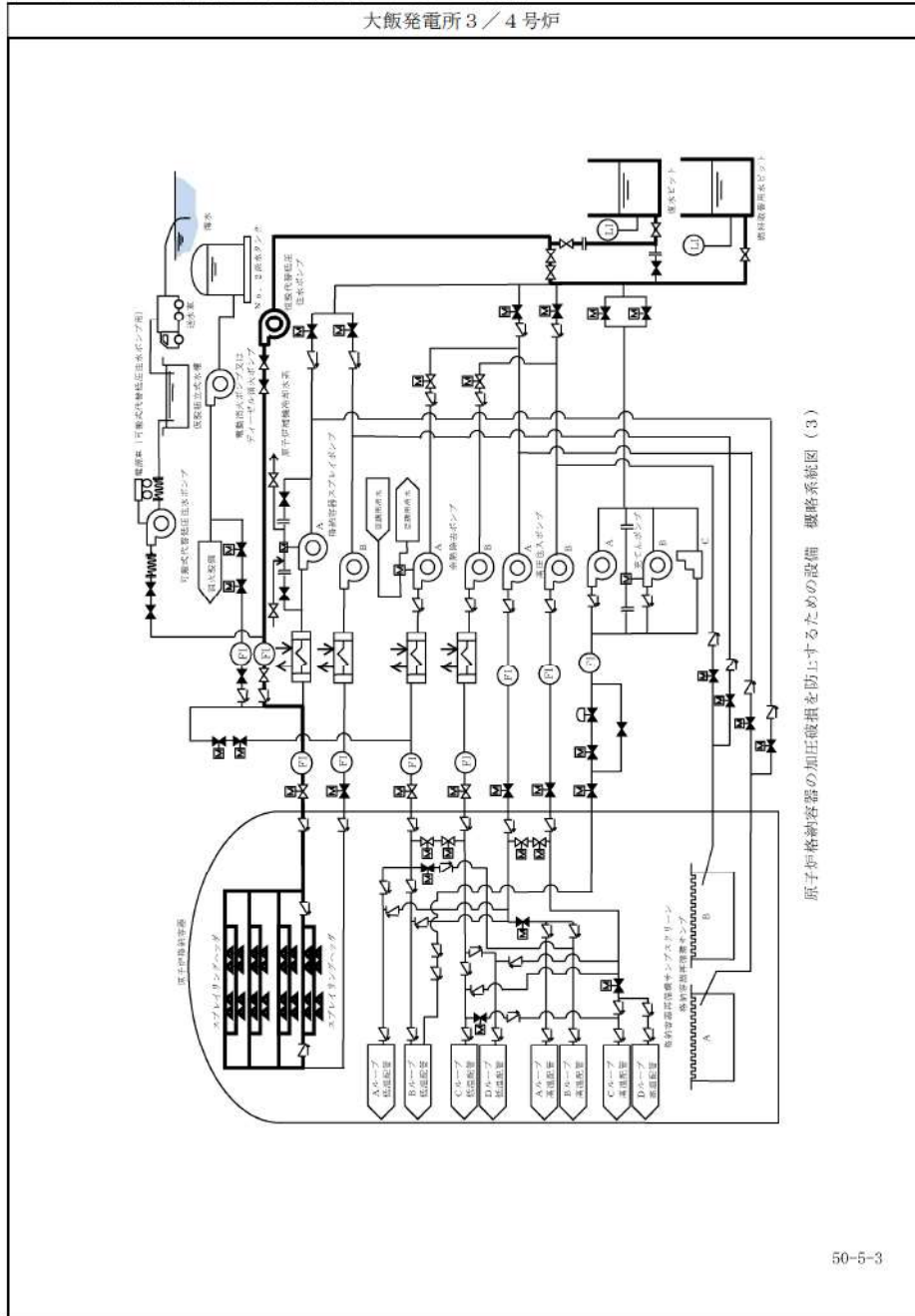

50-5-3

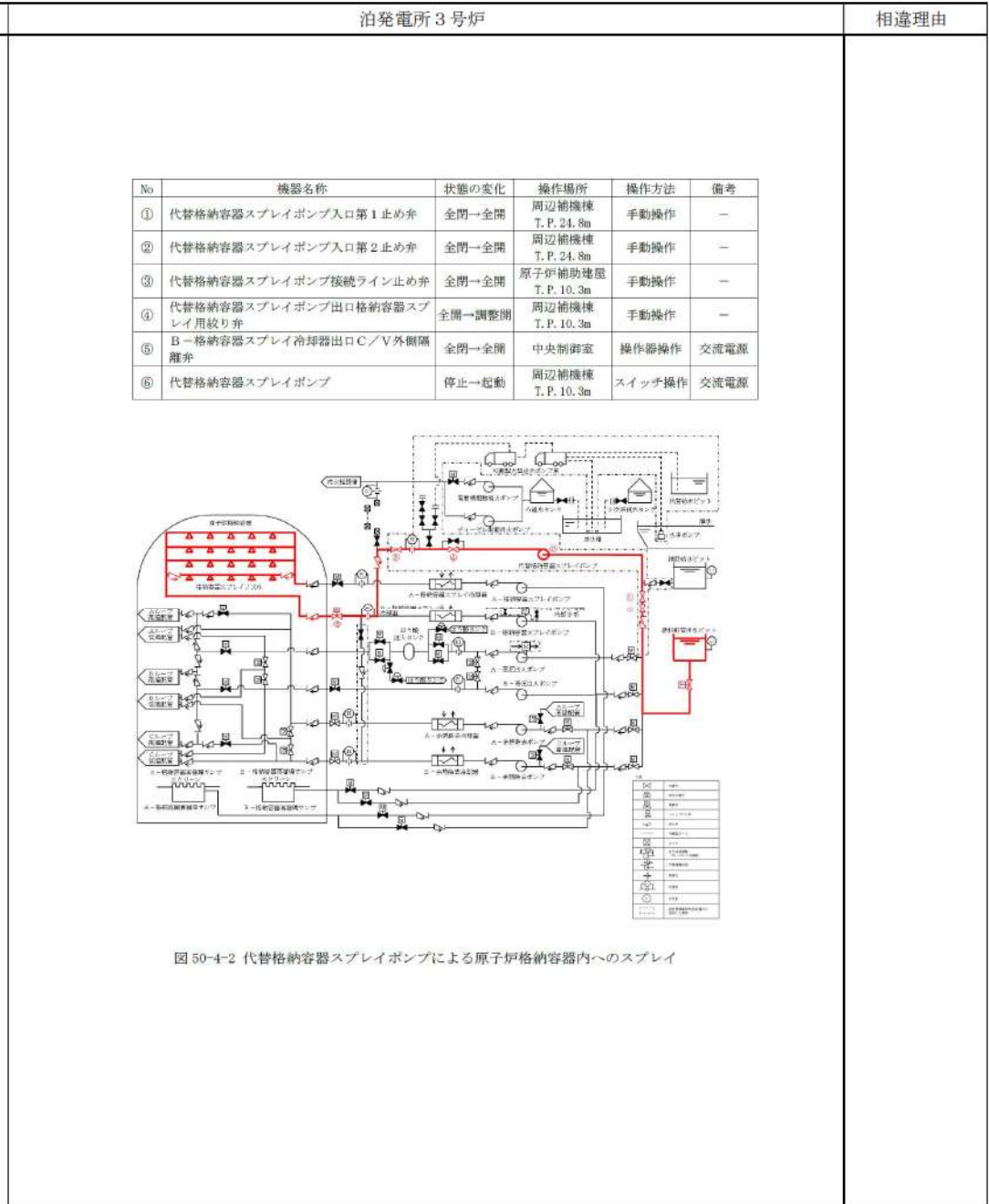

赤字：設備、運用又は体制の相違（設計方針の相違）  
 青字：記載箇所又は記載内容の相違（記載方針の相違）  
 緑字：記載表現、設備名称の相違（実質的な相違なし）

第50条 原子炉格納容器の過圧破損を防止するための設備

大飯発電所3/4号炉	泊発電所3号炉	相違理由																																																																																																																																																																		
	<table border="1"> <thead> <tr> <th>No</th> <th>機器名称</th> <th>状態の変化</th> <th>操作場所</th> <th>操作方法</th> <th>備考</th> </tr> </thead> <tbody> <tr> <td>①</td> <td>A-原子炉補機冷却水ポンプ</td> <td>入→切ロック</td> <td>中央制御室</td> <td>操作器操作</td> <td>交流電源</td> </tr> <tr> <td>②</td> <td>B-原子炉補機冷却水ポンプ</td> <td>入→切ロック</td> <td>中央制御室</td> <td>操作器操作</td> <td>交流電源</td> </tr> <tr> <td>③</td> <td>C-原子炉補機冷却水ポンプ</td> <td>入→切ロック</td> <td>中央制御室</td> <td>操作器操作</td> <td>交流電源</td> </tr> <tr> <td>④</td> <td>D-原子炉補機冷却水ポンプ</td> <td>入→切ロック</td> <td>中央制御室</td> <td>操作器操作</td> <td>交流電源</td> </tr> <tr> <td>⑤</td> <td>原子炉補機冷却水戻り母管B側連絡弁</td> <td>全開→全閉</td> <td>中央制御室</td> <td>操作器操作</td> <td>交流電源</td> </tr> <tr> <td>⑥</td> <td>C-原子炉補機冷却水冷却器補機冷却水出口弁</td> <td>全開→全閉</td> <td>中央制御室</td> <td>操作器操作</td> <td>交流電源</td> </tr> <tr> <td>⑦</td> <td>B-余熱除去冷却器補機冷却水出口弁</td> <td>全閉確認</td> <td>中央制御室</td> <td>操作器操作</td> <td>交流電源 Bヘッダ 供給負荷</td> </tr> <tr> <td>⑧</td> <td>B-格納容器スプレィ冷却器補機冷却水出口弁</td> <td>全閉確認</td> <td>中央制御室</td> <td>操作器操作</td> <td>交流電源 Bヘッダ 供給負荷</td> </tr> <tr> <td>⑨</td> <td>B-使用済燃料ピット冷却器補機冷却水入口弁</td> <td>全開→全閉</td> <td>中央制御室</td> <td>操作器操作</td> <td>交流電源 Bヘッダ 供給負荷</td> </tr> <tr> <td>⑩</td> <td>原子炉補機冷却水戻り母管A側連絡弁</td> <td>全開→全閉</td> <td>中央制御室</td> <td>操作器操作</td> <td>交流電源</td> </tr> <tr> <td>⑪</td> <td>A-原子炉補機冷却水冷却器補機冷却水出口弁</td> <td>全開→全閉</td> <td>中央制御室</td> <td>操作器操作</td> <td>交流電源</td> </tr> <tr> <td>⑫</td> <td>B-原子炉補機冷却水冷却器補機冷却水出口弁</td> <td>全開→全閉</td> <td>中央制御室</td> <td>操作器操作</td> <td>交流電源</td> </tr> <tr> <td>⑬</td> <td>A-余熱除去冷却器補機冷却水出口弁</td> <td>全閉確認</td> <td>中央制御室</td> <td>操作器操作</td> <td>交流電源 Aヘッダ 供給負荷</td> </tr> <tr> <td>⑭</td> <td>A-格納容器スプレィ冷却器補機冷却水出口弁</td> <td>全閉確認</td> <td>中央制御室</td> <td>操作器操作</td> <td>交流電源 Aヘッダ 供給負荷</td> </tr> <tr> <td>⑮</td> <td>A-使用済燃料ピット冷却器補機冷却水入口弁</td> <td>全開→全閉</td> <td>中央制御室</td> <td>操作器操作</td> <td>交流電源 Aヘッダ 供給負荷</td> </tr> <tr> <td>⑯</td> <td>A、B-C/V再循環ユニット補機冷却水入口C/V外側隔離弁</td> <td>全開→全閉</td> <td>中央制御室</td> <td>操作器操作</td> <td>交流電源 Aヘッダ 供給負荷</td> </tr> <tr> <td>⑰</td> <td>原子炉補機冷却水供給母管A側連絡弁</td> <td>全開→開ロック</td> <td>中央制御室</td> <td>操作器操作</td> <td>交流電源</td> </tr> <tr> <td>⑱</td> <td>原子炉補機冷却水供給母管B側連絡弁</td> <td>全開→開ロック</td> <td>中央制御室</td> <td>操作器操作</td> <td>交流電源</td> </tr> <tr> <td>⑲</td> <td>格納容器空気ガスサンプル冷却器補機冷却水入口弁</td> <td>全開→全閉</td> <td>周辺補機棟 T.P.24.8m</td> <td>手動操作</td> <td>Bヘッダ 供給負荷</td> </tr> <tr> <td>⑳</td> <td>A-サンプル冷却器補機冷却水入口弁</td> <td>全開→全閉</td> <td>周辺補機棟 T.P.17.8m</td> <td>手動操作</td> <td>Aヘッダ 供給負荷</td> </tr> <tr> <td>㉑</td> <td>B-サンプル冷却器補機冷却水入口弁</td> <td>全開→全閉</td> <td>周辺補機棟 T.P.17.8m</td> <td>手動操作</td> <td>Bヘッダ 供給負荷</td> </tr> <tr> <td>㉒</td> <td>B-充てんポンプ、電動機補機冷却水A供給ライン第1切替弁</td> <td>全開→全閉</td> <td>原子炉補助建屋 T.P.10.3m</td> <td>手動操作</td> <td>Aヘッダ 供給負荷</td> </tr> <tr> <td>㉓</td> <td>B-充てんポンプ、電動機補機冷却水A供給ライン第2切替弁</td> <td>全開→全閉</td> <td>原子炉補助建屋 T.P.10.3m</td> <td>手動操作</td> <td>Aヘッダ 供給負荷</td> </tr> <tr> <td>㉔</td> <td>A-充てんポンプ、電動機補機冷却水出口弁</td> <td>全開→全閉</td> <td>原子炉補助建屋 T.P.10.3m</td> <td>手動操作</td> <td>Aヘッダ 供給負荷</td> </tr> <tr> <td>㉕</td> <td>B-充てんポンプ、電動機補機冷却水B供給ライン第1切替弁</td> <td>全閉確認</td> <td>原子炉補助建屋 T.P.10.3m</td> <td>手動操作</td> <td>Bヘッダ 供給負荷</td> </tr> <tr> <td>㉖</td> <td>B-充てんポンプ、電動機補機冷却水B供給ライン第2切替弁</td> <td>全閉確認</td> <td>原子炉補助建屋 T.P.10.3m</td> <td>手動操作</td> <td>Bヘッダ 供給負荷</td> </tr> </tbody> </table>	No	機器名称	状態の変化	操作場所	操作方法	備考	①	A-原子炉補機冷却水ポンプ	入→切ロック	中央制御室	操作器操作	交流電源	②	B-原子炉補機冷却水ポンプ	入→切ロック	中央制御室	操作器操作	交流電源	③	C-原子炉補機冷却水ポンプ	入→切ロック	中央制御室	操作器操作	交流電源	④	D-原子炉補機冷却水ポンプ	入→切ロック	中央制御室	操作器操作	交流電源	⑤	原子炉補機冷却水戻り母管B側連絡弁	全開→全閉	中央制御室	操作器操作	交流電源	⑥	C-原子炉補機冷却水冷却器補機冷却水出口弁	全開→全閉	中央制御室	操作器操作	交流電源	⑦	B-余熱除去冷却器補機冷却水出口弁	全閉確認	中央制御室	操作器操作	交流電源 Bヘッダ 供給負荷	⑧	B-格納容器スプレィ冷却器補機冷却水出口弁	全閉確認	中央制御室	操作器操作	交流電源 Bヘッダ 供給負荷	⑨	B-使用済燃料ピット冷却器補機冷却水入口弁	全開→全閉	中央制御室	操作器操作	交流電源 Bヘッダ 供給負荷	⑩	原子炉補機冷却水戻り母管A側連絡弁	全開→全閉	中央制御室	操作器操作	交流電源	⑪	A-原子炉補機冷却水冷却器補機冷却水出口弁	全開→全閉	中央制御室	操作器操作	交流電源	⑫	B-原子炉補機冷却水冷却器補機冷却水出口弁	全開→全閉	中央制御室	操作器操作	交流電源	⑬	A-余熱除去冷却器補機冷却水出口弁	全閉確認	中央制御室	操作器操作	交流電源 Aヘッダ 供給負荷	⑭	A-格納容器スプレィ冷却器補機冷却水出口弁	全閉確認	中央制御室	操作器操作	交流電源 Aヘッダ 供給負荷	⑮	A-使用済燃料ピット冷却器補機冷却水入口弁	全開→全閉	中央制御室	操作器操作	交流電源 Aヘッダ 供給負荷	⑯	A、B-C/V再循環ユニット補機冷却水入口C/V外側隔離弁	全開→全閉	中央制御室	操作器操作	交流電源 Aヘッダ 供給負荷	⑰	原子炉補機冷却水供給母管A側連絡弁	全開→開ロック	中央制御室	操作器操作	交流電源	⑱	原子炉補機冷却水供給母管B側連絡弁	全開→開ロック	中央制御室	操作器操作	交流電源	⑲	格納容器空気ガスサンプル冷却器補機冷却水入口弁	全開→全閉	周辺補機棟 T.P.24.8m	手動操作	Bヘッダ 供給負荷	⑳	A-サンプル冷却器補機冷却水入口弁	全開→全閉	周辺補機棟 T.P.17.8m	手動操作	Aヘッダ 供給負荷	㉑	B-サンプル冷却器補機冷却水入口弁	全開→全閉	周辺補機棟 T.P.17.8m	手動操作	Bヘッダ 供給負荷	㉒	B-充てんポンプ、電動機補機冷却水A供給ライン第1切替弁	全開→全閉	原子炉補助建屋 T.P.10.3m	手動操作	Aヘッダ 供給負荷	㉓	B-充てんポンプ、電動機補機冷却水A供給ライン第2切替弁	全開→全閉	原子炉補助建屋 T.P.10.3m	手動操作	Aヘッダ 供給負荷	㉔	A-充てんポンプ、電動機補機冷却水出口弁	全開→全閉	原子炉補助建屋 T.P.10.3m	手動操作	Aヘッダ 供給負荷	㉕	B-充てんポンプ、電動機補機冷却水B供給ライン第1切替弁	全閉確認	原子炉補助建屋 T.P.10.3m	手動操作	Bヘッダ 供給負荷	㉖	B-充てんポンプ、電動機補機冷却水B供給ライン第2切替弁	全閉確認	原子炉補助建屋 T.P.10.3m	手動操作	Bヘッダ 供給負荷	
No	機器名称	状態の変化	操作場所	操作方法	備考																																																																																																																																																															
①	A-原子炉補機冷却水ポンプ	入→切ロック	中央制御室	操作器操作	交流電源																																																																																																																																																															
②	B-原子炉補機冷却水ポンプ	入→切ロック	中央制御室	操作器操作	交流電源																																																																																																																																																															
③	C-原子炉補機冷却水ポンプ	入→切ロック	中央制御室	操作器操作	交流電源																																																																																																																																																															
④	D-原子炉補機冷却水ポンプ	入→切ロック	中央制御室	操作器操作	交流電源																																																																																																																																																															
⑤	原子炉補機冷却水戻り母管B側連絡弁	全開→全閉	中央制御室	操作器操作	交流電源																																																																																																																																																															
⑥	C-原子炉補機冷却水冷却器補機冷却水出口弁	全開→全閉	中央制御室	操作器操作	交流電源																																																																																																																																																															
⑦	B-余熱除去冷却器補機冷却水出口弁	全閉確認	中央制御室	操作器操作	交流電源 Bヘッダ 供給負荷																																																																																																																																																															
⑧	B-格納容器スプレィ冷却器補機冷却水出口弁	全閉確認	中央制御室	操作器操作	交流電源 Bヘッダ 供給負荷																																																																																																																																																															
⑨	B-使用済燃料ピット冷却器補機冷却水入口弁	全開→全閉	中央制御室	操作器操作	交流電源 Bヘッダ 供給負荷																																																																																																																																																															
⑩	原子炉補機冷却水戻り母管A側連絡弁	全開→全閉	中央制御室	操作器操作	交流電源																																																																																																																																																															
⑪	A-原子炉補機冷却水冷却器補機冷却水出口弁	全開→全閉	中央制御室	操作器操作	交流電源																																																																																																																																																															
⑫	B-原子炉補機冷却水冷却器補機冷却水出口弁	全開→全閉	中央制御室	操作器操作	交流電源																																																																																																																																																															
⑬	A-余熱除去冷却器補機冷却水出口弁	全閉確認	中央制御室	操作器操作	交流電源 Aヘッダ 供給負荷																																																																																																																																																															
⑭	A-格納容器スプレィ冷却器補機冷却水出口弁	全閉確認	中央制御室	操作器操作	交流電源 Aヘッダ 供給負荷																																																																																																																																																															
⑮	A-使用済燃料ピット冷却器補機冷却水入口弁	全開→全閉	中央制御室	操作器操作	交流電源 Aヘッダ 供給負荷																																																																																																																																																															
⑯	A、B-C/V再循環ユニット補機冷却水入口C/V外側隔離弁	全開→全閉	中央制御室	操作器操作	交流電源 Aヘッダ 供給負荷																																																																																																																																																															
⑰	原子炉補機冷却水供給母管A側連絡弁	全開→開ロック	中央制御室	操作器操作	交流電源																																																																																																																																																															
⑱	原子炉補機冷却水供給母管B側連絡弁	全開→開ロック	中央制御室	操作器操作	交流電源																																																																																																																																																															
⑲	格納容器空気ガスサンプル冷却器補機冷却水入口弁	全開→全閉	周辺補機棟 T.P.24.8m	手動操作	Bヘッダ 供給負荷																																																																																																																																																															
⑳	A-サンプル冷却器補機冷却水入口弁	全開→全閉	周辺補機棟 T.P.17.8m	手動操作	Aヘッダ 供給負荷																																																																																																																																																															
㉑	B-サンプル冷却器補機冷却水入口弁	全開→全閉	周辺補機棟 T.P.17.8m	手動操作	Bヘッダ 供給負荷																																																																																																																																																															
㉒	B-充てんポンプ、電動機補機冷却水A供給ライン第1切替弁	全開→全閉	原子炉補助建屋 T.P.10.3m	手動操作	Aヘッダ 供給負荷																																																																																																																																																															
㉓	B-充てんポンプ、電動機補機冷却水A供給ライン第2切替弁	全開→全閉	原子炉補助建屋 T.P.10.3m	手動操作	Aヘッダ 供給負荷																																																																																																																																																															
㉔	A-充てんポンプ、電動機補機冷却水出口弁	全開→全閉	原子炉補助建屋 T.P.10.3m	手動操作	Aヘッダ 供給負荷																																																																																																																																																															
㉕	B-充てんポンプ、電動機補機冷却水B供給ライン第1切替弁	全閉確認	原子炉補助建屋 T.P.10.3m	手動操作	Bヘッダ 供給負荷																																																																																																																																																															
㉖	B-充てんポンプ、電動機補機冷却水B供給ライン第2切替弁	全閉確認	原子炉補助建屋 T.P.10.3m	手動操作	Bヘッダ 供給負荷																																																																																																																																																															

泊発電所3号炉 SA基準適合性 比較表

赤字：設備、運用又は体制の相違（設計方針の相違）  
 青字：記載箇所又は記載内容の相違（記載方針の相違）  
 緑字：記載表現、設備名称の相違（実質的な相違なし）

第50条 原子炉格納容器の過圧破損を防止するための設備

大飯発電所3 / 4号炉	泊発電所3号炉				相違理由	
	㉓	C-充てんポンプ、電動機補機冷却水出口弁	全開→全閉	原子炉補助建屋 T.P. 10. 3m	手動操作	Bヘッダ 供給負荷
	㉔	B-高圧注入ポンプ電動機補機冷却水出口弁	調整開→全閉	原子炉補助建屋 T.P. -1. 7m	手動操作	Bヘッダ 供給負荷
	㉕	B-高圧注入ポンプ、油冷却器補機冷却水出口弁	全開→全閉	原子炉補助建屋 T.P. -1. 7m	手動操作	Bヘッダ 供給負荷
	㉖	B-格納容器スプレイポンプ補機冷却水出口止め弁	全開→全閉	原子炉補助建屋 T.P. -1. 7m	手動操作	Bヘッダ 供給負荷
	㉗	B-余熱除去ポンプ電動機補機冷却水出口弁	調整開→全閉	原子炉補助建屋 T.P. -1. 7m	手動操作	Bヘッダ 供給負荷
	㉘	B-余熱除去ポンプ補機冷却水出口弁	調整開→全閉	原子炉補助建屋 T.P. -1. 7m	手動操作	Bヘッダ 供給負荷
	㉙	A-余熱除去ポンプ電動機補機冷却水出口弁	調整開→全閉	原子炉補助建屋 T.P. -1. 7m	手動操作	Aヘッダ 供給負荷
	㉚	A-余熱除去ポンプ補機冷却水出口弁	調整開→全閉	原子炉補助建屋 T.P. -1. 7m	手動操作	Aヘッダ 供給負荷
	㉛	A-格納容器スプレイポンプ電動機補機冷却水出口弁	調整開→全閉	原子炉補助建屋 T.P. -1. 7m	手動操作	Aヘッダ 供給負荷
	㉜	A-格納容器スプレイポンプ補機冷却水出口弁	調整開→全閉	原子炉補助建屋 T.P. -1. 7m	手動操作	Aヘッダ 供給負荷
	㉝	A-高圧注入ポンプ電動機補機冷却水出口弁	調整開→全閉	原子炉補助建屋 T.P. -1. 7m	手動操作	Aヘッダ 供給負荷
	㉞	A-高圧注入ポンプ、油冷却器補機冷却水出口弁	全開→全閉	原子炉補助建屋 T.P. -1. 7m	手動操作	Aヘッダ 供給負荷
	㉟	A-制御用空気圧縮装置補機冷却水入口弁	全開→全閉	周辺補機棟 T.P. 10. 3m	手動操作	Aヘッダ 供給負荷
	㊱	B-制御用空気圧縮装置補機冷却水入口弁	全開→全閉	周辺補機棟 T.P. 10. 3m	手動操作	Bヘッダ 供給負荷
	㊲	C-原子炉補機冷却水供給母管止め弁	全開→全閉	周辺補機棟 T.P. 2. 3m 中間床	手動操作	—
	㊳	原子炉補機冷却水モニタAライン入口止め弁	全開→全閉	周辺補機棟 T.P. 2. 3m 中間床	手動操作	—
	㊴	原子炉補機冷却水モニタAライン戻り弁	全開→全閉	周辺補機棟 T.P. 2. 3m 中間床	手動操作	—
	㊵	A、B-原子炉補機冷却水ポンプ電動機補機冷却水出口弁	全開→全閉	周辺補機棟 T.P. 2. 3m 中間床	手動操作	Aヘッダ 供給負荷
	㊶	原子炉補機冷却水モニタBライン入口止め弁	全開→全閉	周辺補機棟 T.P. 2. 3m 中間床	手動操作	—
	㊷	原子炉補機冷却水モニタBライン戻り弁	全開→全閉	周辺補機棟 T.P. 2. 3m 中間床	手動操作	—
	㊸	C、D-原子炉補機冷却水ポンプ電動機補機冷却水出口弁	全開→全閉	周辺補機棟 T.P. 2. 3m 中間床	手動操作	Bヘッダ 供給負荷
	㊹	原子炉補機冷却水Aサージライン止め弁	全開→全閉	周辺補機棟 T.P. 43. 6m	手動操作	—
	㊺	原子炉補機冷却水Bサージライン止め弁	全開→全閉	周辺補機棟 T.P. 43. 6m	手動操作	—
	㊻	可搬型ホース	ホース接続	屋外	接続操作	—
	㊼	原子炉補機冷却水東側接続用ライン止め弁 (SA対策)	全開→全閉	屋外	手動操作	—
	㊽	可搬型ホース	ホース接続	屋外	接続操作	—
	㊾	可搬型温度計測装置 (格納容器再循環ユニット入口温度/出口温度)	取付け	周辺補機棟 T.P. 10. 3m 中間床	—	—

赤字：設備、運用又は体制の相違（設計方針の相違）  
 青字：記載箇所又は記載内容の相違（記載方針の相違）  
 緑字：記載表現、設備名称の相違（実質的な相違なし）

第50条 原子炉格納容器の過圧破損を防止するための設備

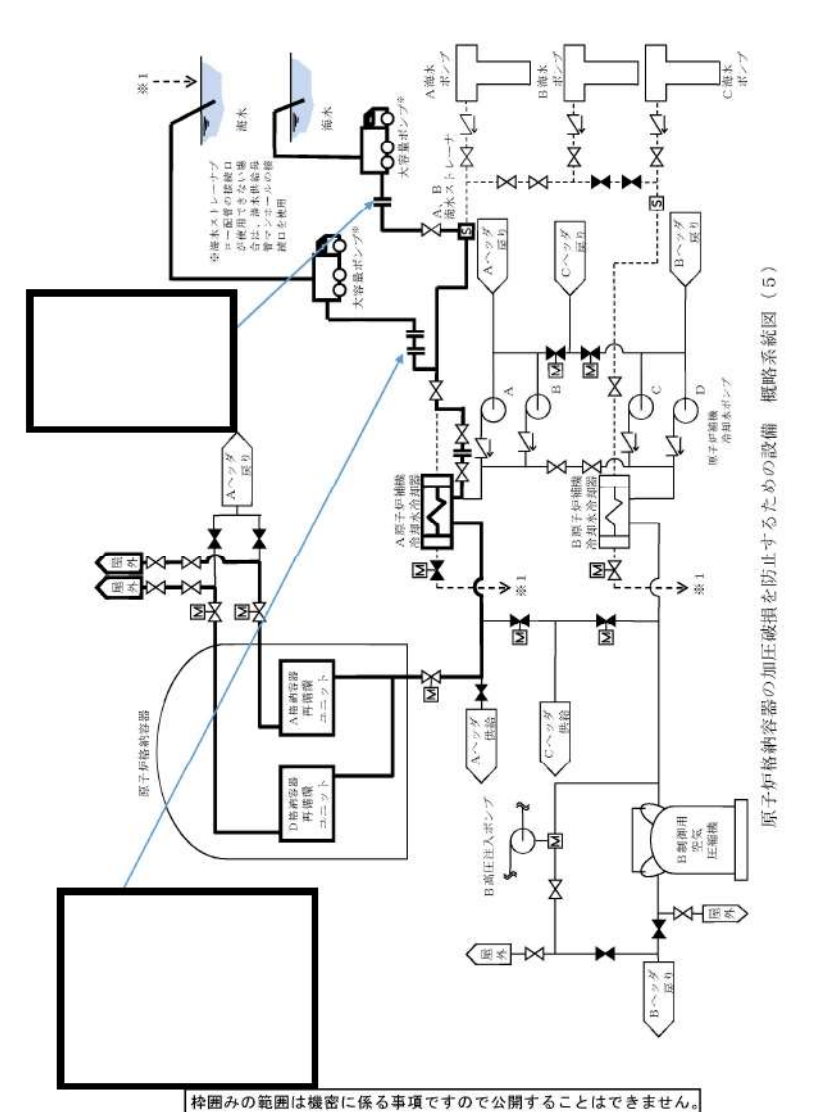
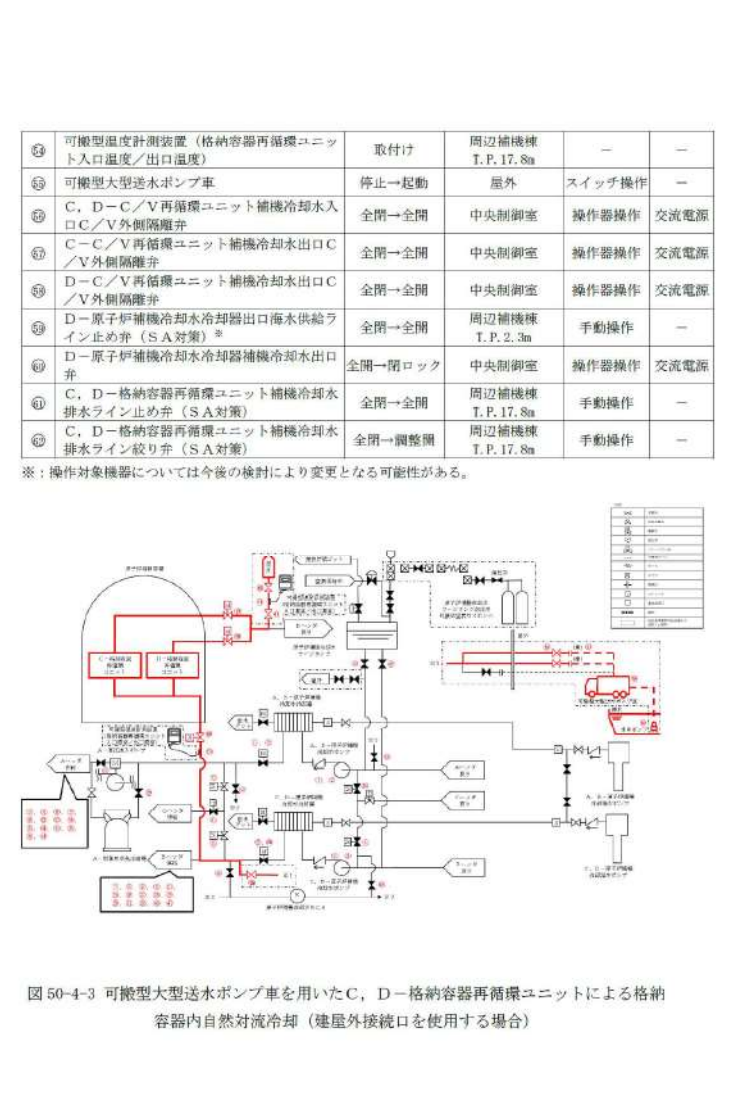
大飯発電所3/4号炉	泊発電所3号炉	相違理由																																																												
 <p>概略系統図(5) 原子炉格納容器の加圧破損を防止するための設備</p> <p>枠囲みの範囲は機密に係る事項ですので公開することはできません。</p>	 <p>図 50-4-3 可搬型大型送水ポンプ車を用いたC、D-格納容器再循環ユニットによる格納容器内自然対流冷却（建屋外接続口を使用する場合）</p> <table border="1" data-bbox="1164 367 1904 702"> <thead> <tr> <th>設備番号</th> <th>設備名</th> <th>取付け</th> <th>周辺補機棟</th> <th>操作</th> <th>電源</th> </tr> </thead> <tbody> <tr> <td>④</td> <td>可搬型温度計測装置（格納容器再循環ユニット入口温度/出口温度）</td> <td>取付け</td> <td>I.P. 17. 8a</td> <td>—</td> <td>—</td> </tr> <tr> <td>⑤</td> <td>可搬型大型送水ポンプ車</td> <td>停止→起動</td> <td>屋外</td> <td>スイッチ操作</td> <td>—</td> </tr> <tr> <td>⑥</td> <td>C、D-C/V再循環ユニット補機冷却水入口C/V外側隔離弁</td> <td>全閉→全開</td> <td>中央制御室</td> <td>操作器操作</td> <td>交流電源</td> </tr> <tr> <td>⑦</td> <td>C-C/V再循環ユニット補機冷却水出口C/V外側隔離弁</td> <td>全閉→全開</td> <td>中央制御室</td> <td>操作器操作</td> <td>交流電源</td> </tr> <tr> <td>⑧</td> <td>D-C/V再循環ユニット補機冷却水出口C/V外側隔離弁</td> <td>全閉→全開</td> <td>中央制御室</td> <td>操作器操作</td> <td>交流電源</td> </tr> <tr> <td>⑨</td> <td>D-原子炉補機冷却水冷却器出口海水供給ライン止め弁（SA対策）※</td> <td>全閉→全開</td> <td>周辺補機棟 I.P. 2. 3a</td> <td>手動操作</td> <td>—</td> </tr> <tr> <td>⑩</td> <td>D-原子炉補機冷却水冷却器補機冷却水出口弁</td> <td>全開→閉ロック</td> <td>中央制御室</td> <td>操作器操作</td> <td>交流電源</td> </tr> <tr> <td>⑪</td> <td>C、D-格納容器再循環ユニット補機冷却水排水ライン止め弁（SA対策）</td> <td>全閉→全開</td> <td>周辺補機棟 I.P. 17. 8a</td> <td>手動操作</td> <td>—</td> </tr> <tr> <td>⑫</td> <td>C、D-格納容器再循環ユニット補機冷却水排水ライン絞り弁（SA対策）</td> <td>全閉→調整開</td> <td>周辺補機棟 I.P. 17. 8a</td> <td>手動操作</td> <td>—</td> </tr> </tbody> </table> <p>※：操作対象機器については今後の検討により変更となる可能性がある。</p>	設備番号	設備名	取付け	周辺補機棟	操作	電源	④	可搬型温度計測装置（格納容器再循環ユニット入口温度/出口温度）	取付け	I.P. 17. 8a	—	—	⑤	可搬型大型送水ポンプ車	停止→起動	屋外	スイッチ操作	—	⑥	C、D-C/V再循環ユニット補機冷却水入口C/V外側隔離弁	全閉→全開	中央制御室	操作器操作	交流電源	⑦	C-C/V再循環ユニット補機冷却水出口C/V外側隔離弁	全閉→全開	中央制御室	操作器操作	交流電源	⑧	D-C/V再循環ユニット補機冷却水出口C/V外側隔離弁	全閉→全開	中央制御室	操作器操作	交流電源	⑨	D-原子炉補機冷却水冷却器出口海水供給ライン止め弁（SA対策）※	全閉→全開	周辺補機棟 I.P. 2. 3a	手動操作	—	⑩	D-原子炉補機冷却水冷却器補機冷却水出口弁	全開→閉ロック	中央制御室	操作器操作	交流電源	⑪	C、D-格納容器再循環ユニット補機冷却水排水ライン止め弁（SA対策）	全閉→全開	周辺補機棟 I.P. 17. 8a	手動操作	—	⑫	C、D-格納容器再循環ユニット補機冷却水排水ライン絞り弁（SA対策）	全閉→調整開	周辺補機棟 I.P. 17. 8a	手動操作	—	
設備番号	設備名	取付け	周辺補機棟	操作	電源																																																									
④	可搬型温度計測装置（格納容器再循環ユニット入口温度/出口温度）	取付け	I.P. 17. 8a	—	—																																																									
⑤	可搬型大型送水ポンプ車	停止→起動	屋外	スイッチ操作	—																																																									
⑥	C、D-C/V再循環ユニット補機冷却水入口C/V外側隔離弁	全閉→全開	中央制御室	操作器操作	交流電源																																																									
⑦	C-C/V再循環ユニット補機冷却水出口C/V外側隔離弁	全閉→全開	中央制御室	操作器操作	交流電源																																																									
⑧	D-C/V再循環ユニット補機冷却水出口C/V外側隔離弁	全閉→全開	中央制御室	操作器操作	交流電源																																																									
⑨	D-原子炉補機冷却水冷却器出口海水供給ライン止め弁（SA対策）※	全閉→全開	周辺補機棟 I.P. 2. 3a	手動操作	—																																																									
⑩	D-原子炉補機冷却水冷却器補機冷却水出口弁	全開→閉ロック	中央制御室	操作器操作	交流電源																																																									
⑪	C、D-格納容器再循環ユニット補機冷却水排水ライン止め弁（SA対策）	全閉→全開	周辺補機棟 I.P. 17. 8a	手動操作	—																																																									
⑫	C、D-格納容器再循環ユニット補機冷却水排水ライン絞り弁（SA対策）	全閉→調整開	周辺補機棟 I.P. 17. 8a	手動操作	—																																																									

赤字：設備、運用又は体制の相違（設計方針の相違）  
 青字：記載箇所又は記載内容の相違（記載方針の相違）  
 緑字：記載表現、設備名称の相違（実質的な相違なし）

第50条 原子炉格納容器の過圧破損を防止するための設備

大飯発電所3/4号炉	泊発電所3号炉	相違理由																																																																																																																																																																		
	<table border="1"> <thead> <tr> <th>No</th> <th>機器名称</th> <th>状態の変化</th> <th>操作場所</th> <th>操作方法</th> <th>備考</th> </tr> </thead> <tbody> <tr> <td>①</td> <td>A-原子炉補機冷却水ポンプ</td> <td>入→切ロック</td> <td>中央制御室</td> <td>操作器操作</td> <td>交流電源</td> </tr> <tr> <td>②</td> <td>B-原子炉補機冷却水ポンプ</td> <td>入→切ロック</td> <td>中央制御室</td> <td>操作器操作</td> <td>交流電源</td> </tr> <tr> <td>③</td> <td>C-原子炉補機冷却水ポンプ</td> <td>入→切ロック</td> <td>中央制御室</td> <td>操作器操作</td> <td>交流電源</td> </tr> <tr> <td>④</td> <td>D-原子炉補機冷却水ポンプ</td> <td>入→切ロック</td> <td>中央制御室</td> <td>操作器操作</td> <td>交流電源</td> </tr> <tr> <td>⑤</td> <td>原子炉補機冷却水戻り母管B側連絡弁</td> <td>全開→全閉</td> <td>中央制御室</td> <td>操作器操作</td> <td>交流電源</td> </tr> <tr> <td>⑥</td> <td>C-原子炉補機冷却水冷却器補機冷却水出口弁</td> <td>全開→全閉</td> <td>中央制御室</td> <td>操作器操作</td> <td>交流電源</td> </tr> <tr> <td>⑦</td> <td>B-余熱除去冷却器補機冷却水出口弁</td> <td>全閉確認</td> <td>中央制御室</td> <td>操作器操作</td> <td>交流電源 Bヘッダ 供給負荷</td> </tr> <tr> <td>⑧</td> <td>B-格納容器スプレイ冷却器補機冷却水出口弁</td> <td>全閉確認</td> <td>中央制御室</td> <td>操作器操作</td> <td>交流電源 Bヘッダ 供給負荷</td> </tr> <tr> <td>⑨</td> <td>B-使用済燃料ピット冷却器補機冷却水入口弁</td> <td>全開→全閉</td> <td>中央制御室</td> <td>操作器操作</td> <td>交流電源 Bヘッダ 供給負荷</td> </tr> <tr> <td>⑩</td> <td>原子炉補機冷却水戻り母管A側連絡弁</td> <td>全開→全閉</td> <td>中央制御室</td> <td>操作器操作</td> <td>交流電源</td> </tr> <tr> <td>⑪</td> <td>A-原子炉補機冷却水冷却器補機冷却水出口弁</td> <td>全開→全閉</td> <td>中央制御室</td> <td>操作器操作</td> <td>交流電源</td> </tr> <tr> <td>⑫</td> <td>B-原子炉補機冷却水冷却器補機冷却水出口弁</td> <td>全開→全閉</td> <td>中央制御室</td> <td>操作器操作</td> <td>交流電源</td> </tr> <tr> <td>⑬</td> <td>A-余熱除去冷却器補機冷却水出口弁</td> <td>全閉確認</td> <td>中央制御室</td> <td>操作器操作</td> <td>交流電源 Aヘッダ 供給負荷</td> </tr> <tr> <td>⑭</td> <td>A-格納容器スプレイ冷却器補機冷却水出口弁</td> <td>全閉確認</td> <td>中央制御室</td> <td>操作器操作</td> <td>交流電源 Aヘッダ 供給負荷</td> </tr> <tr> <td>⑮</td> <td>A-使用済燃料ピット冷却器補機冷却水入口弁</td> <td>全開→全閉</td> <td>中央制御室</td> <td>操作器操作</td> <td>交流電源 Aヘッダ 供給負荷</td> </tr> <tr> <td>⑯</td> <td>A、B-C/V再循環ユニット補機冷却水入口C/V外側隔離弁</td> <td>全開→全閉</td> <td>中央制御室</td> <td>操作器操作</td> <td>Aヘッダ 供給負荷</td> </tr> <tr> <td>⑰</td> <td>原子炉補機冷却水供給母管A側連絡弁</td> <td>全開→開ロック</td> <td>中央制御室</td> <td>操作器操作</td> <td>交流電源</td> </tr> <tr> <td>⑱</td> <td>原子炉補機冷却水供給母管B側連絡弁</td> <td>全開→開ロック</td> <td>中央制御室</td> <td>操作器操作</td> <td>交流電源</td> </tr> <tr> <td>⑲</td> <td>格納容器雰囲気ガスサンプル冷却器補機冷却水入口弁</td> <td>全開→全閉</td> <td>周辺補機棟 T.P.24.8m</td> <td>手動操作</td> <td>Bヘッダ 供給負荷</td> </tr> <tr> <td>⑳</td> <td>A-サンプル冷却器補機冷却水入口弁</td> <td>全開→全閉</td> <td>周辺補機棟 T.P.17.8m</td> <td>手動操作</td> <td>Aヘッダ 供給負荷</td> </tr> <tr> <td>㉑</td> <td>B-サンプル冷却器補機冷却水入口弁</td> <td>全開→全閉</td> <td>周辺補機棟 T.P.17.8m</td> <td>手動操作</td> <td>Bヘッダ 供給負荷</td> </tr> <tr> <td>㉒</td> <td>B-充てんポンプ、電動機補機冷却水A供給ライン第1切替弁</td> <td>全開→全閉</td> <td>原子炉補助建屋 T.P.10.3m</td> <td>手動操作</td> <td>Aヘッダ 供給負荷</td> </tr> <tr> <td>㉓</td> <td>B-充てんポンプ、電動機補機冷却水A供給ライン第2切替弁</td> <td>全開→全閉</td> <td>原子炉補助建屋 T.P.10.3m</td> <td>手動操作</td> <td>Aヘッダ 供給負荷</td> </tr> <tr> <td>㉔</td> <td>A-充てんポンプ、電動機補機冷却水出口弁</td> <td>全開→全閉</td> <td>原子炉補助建屋 T.P.10.3m</td> <td>手動操作</td> <td>Aヘッダ 供給負荷</td> </tr> <tr> <td>㉕</td> <td>B-充てんポンプ、電動機補機冷却水B供給ライン第1切替弁</td> <td>全閉確認</td> <td>原子炉補助建屋 T.P.10.3m</td> <td>手動操作</td> <td>Bヘッダ 供給負荷</td> </tr> <tr> <td>㉖</td> <td>B-充てんポンプ、電動機補機冷却水B供給ライン第2切替弁</td> <td>全閉確認</td> <td>原子炉補助建屋 T.P.10.3m</td> <td>手動操作</td> <td>Bヘッダ 供給負荷</td> </tr> </tbody> </table>	No	機器名称	状態の変化	操作場所	操作方法	備考	①	A-原子炉補機冷却水ポンプ	入→切ロック	中央制御室	操作器操作	交流電源	②	B-原子炉補機冷却水ポンプ	入→切ロック	中央制御室	操作器操作	交流電源	③	C-原子炉補機冷却水ポンプ	入→切ロック	中央制御室	操作器操作	交流電源	④	D-原子炉補機冷却水ポンプ	入→切ロック	中央制御室	操作器操作	交流電源	⑤	原子炉補機冷却水戻り母管B側連絡弁	全開→全閉	中央制御室	操作器操作	交流電源	⑥	C-原子炉補機冷却水冷却器補機冷却水出口弁	全開→全閉	中央制御室	操作器操作	交流電源	⑦	B-余熱除去冷却器補機冷却水出口弁	全閉確認	中央制御室	操作器操作	交流電源 Bヘッダ 供給負荷	⑧	B-格納容器スプレイ冷却器補機冷却水出口弁	全閉確認	中央制御室	操作器操作	交流電源 Bヘッダ 供給負荷	⑨	B-使用済燃料ピット冷却器補機冷却水入口弁	全開→全閉	中央制御室	操作器操作	交流電源 Bヘッダ 供給負荷	⑩	原子炉補機冷却水戻り母管A側連絡弁	全開→全閉	中央制御室	操作器操作	交流電源	⑪	A-原子炉補機冷却水冷却器補機冷却水出口弁	全開→全閉	中央制御室	操作器操作	交流電源	⑫	B-原子炉補機冷却水冷却器補機冷却水出口弁	全開→全閉	中央制御室	操作器操作	交流電源	⑬	A-余熱除去冷却器補機冷却水出口弁	全閉確認	中央制御室	操作器操作	交流電源 Aヘッダ 供給負荷	⑭	A-格納容器スプレイ冷却器補機冷却水出口弁	全閉確認	中央制御室	操作器操作	交流電源 Aヘッダ 供給負荷	⑮	A-使用済燃料ピット冷却器補機冷却水入口弁	全開→全閉	中央制御室	操作器操作	交流電源 Aヘッダ 供給負荷	⑯	A、B-C/V再循環ユニット補機冷却水入口C/V外側隔離弁	全開→全閉	中央制御室	操作器操作	Aヘッダ 供給負荷	⑰	原子炉補機冷却水供給母管A側連絡弁	全開→開ロック	中央制御室	操作器操作	交流電源	⑱	原子炉補機冷却水供給母管B側連絡弁	全開→開ロック	中央制御室	操作器操作	交流電源	⑲	格納容器雰囲気ガスサンプル冷却器補機冷却水入口弁	全開→全閉	周辺補機棟 T.P.24.8m	手動操作	Bヘッダ 供給負荷	⑳	A-サンプル冷却器補機冷却水入口弁	全開→全閉	周辺補機棟 T.P.17.8m	手動操作	Aヘッダ 供給負荷	㉑	B-サンプル冷却器補機冷却水入口弁	全開→全閉	周辺補機棟 T.P.17.8m	手動操作	Bヘッダ 供給負荷	㉒	B-充てんポンプ、電動機補機冷却水A供給ライン第1切替弁	全開→全閉	原子炉補助建屋 T.P.10.3m	手動操作	Aヘッダ 供給負荷	㉓	B-充てんポンプ、電動機補機冷却水A供給ライン第2切替弁	全開→全閉	原子炉補助建屋 T.P.10.3m	手動操作	Aヘッダ 供給負荷	㉔	A-充てんポンプ、電動機補機冷却水出口弁	全開→全閉	原子炉補助建屋 T.P.10.3m	手動操作	Aヘッダ 供給負荷	㉕	B-充てんポンプ、電動機補機冷却水B供給ライン第1切替弁	全閉確認	原子炉補助建屋 T.P.10.3m	手動操作	Bヘッダ 供給負荷	㉖	B-充てんポンプ、電動機補機冷却水B供給ライン第2切替弁	全閉確認	原子炉補助建屋 T.P.10.3m	手動操作	Bヘッダ 供給負荷	
No	機器名称	状態の変化	操作場所	操作方法	備考																																																																																																																																																															
①	A-原子炉補機冷却水ポンプ	入→切ロック	中央制御室	操作器操作	交流電源																																																																																																																																																															
②	B-原子炉補機冷却水ポンプ	入→切ロック	中央制御室	操作器操作	交流電源																																																																																																																																																															
③	C-原子炉補機冷却水ポンプ	入→切ロック	中央制御室	操作器操作	交流電源																																																																																																																																																															
④	D-原子炉補機冷却水ポンプ	入→切ロック	中央制御室	操作器操作	交流電源																																																																																																																																																															
⑤	原子炉補機冷却水戻り母管B側連絡弁	全開→全閉	中央制御室	操作器操作	交流電源																																																																																																																																																															
⑥	C-原子炉補機冷却水冷却器補機冷却水出口弁	全開→全閉	中央制御室	操作器操作	交流電源																																																																																																																																																															
⑦	B-余熱除去冷却器補機冷却水出口弁	全閉確認	中央制御室	操作器操作	交流電源 Bヘッダ 供給負荷																																																																																																																																																															
⑧	B-格納容器スプレイ冷却器補機冷却水出口弁	全閉確認	中央制御室	操作器操作	交流電源 Bヘッダ 供給負荷																																																																																																																																																															
⑨	B-使用済燃料ピット冷却器補機冷却水入口弁	全開→全閉	中央制御室	操作器操作	交流電源 Bヘッダ 供給負荷																																																																																																																																																															
⑩	原子炉補機冷却水戻り母管A側連絡弁	全開→全閉	中央制御室	操作器操作	交流電源																																																																																																																																																															
⑪	A-原子炉補機冷却水冷却器補機冷却水出口弁	全開→全閉	中央制御室	操作器操作	交流電源																																																																																																																																																															
⑫	B-原子炉補機冷却水冷却器補機冷却水出口弁	全開→全閉	中央制御室	操作器操作	交流電源																																																																																																																																																															
⑬	A-余熱除去冷却器補機冷却水出口弁	全閉確認	中央制御室	操作器操作	交流電源 Aヘッダ 供給負荷																																																																																																																																																															
⑭	A-格納容器スプレイ冷却器補機冷却水出口弁	全閉確認	中央制御室	操作器操作	交流電源 Aヘッダ 供給負荷																																																																																																																																																															
⑮	A-使用済燃料ピット冷却器補機冷却水入口弁	全開→全閉	中央制御室	操作器操作	交流電源 Aヘッダ 供給負荷																																																																																																																																																															
⑯	A、B-C/V再循環ユニット補機冷却水入口C/V外側隔離弁	全開→全閉	中央制御室	操作器操作	Aヘッダ 供給負荷																																																																																																																																																															
⑰	原子炉補機冷却水供給母管A側連絡弁	全開→開ロック	中央制御室	操作器操作	交流電源																																																																																																																																																															
⑱	原子炉補機冷却水供給母管B側連絡弁	全開→開ロック	中央制御室	操作器操作	交流電源																																																																																																																																																															
⑲	格納容器雰囲気ガスサンプル冷却器補機冷却水入口弁	全開→全閉	周辺補機棟 T.P.24.8m	手動操作	Bヘッダ 供給負荷																																																																																																																																																															
⑳	A-サンプル冷却器補機冷却水入口弁	全開→全閉	周辺補機棟 T.P.17.8m	手動操作	Aヘッダ 供給負荷																																																																																																																																																															
㉑	B-サンプル冷却器補機冷却水入口弁	全開→全閉	周辺補機棟 T.P.17.8m	手動操作	Bヘッダ 供給負荷																																																																																																																																																															
㉒	B-充てんポンプ、電動機補機冷却水A供給ライン第1切替弁	全開→全閉	原子炉補助建屋 T.P.10.3m	手動操作	Aヘッダ 供給負荷																																																																																																																																																															
㉓	B-充てんポンプ、電動機補機冷却水A供給ライン第2切替弁	全開→全閉	原子炉補助建屋 T.P.10.3m	手動操作	Aヘッダ 供給負荷																																																																																																																																																															
㉔	A-充てんポンプ、電動機補機冷却水出口弁	全開→全閉	原子炉補助建屋 T.P.10.3m	手動操作	Aヘッダ 供給負荷																																																																																																																																																															
㉕	B-充てんポンプ、電動機補機冷却水B供給ライン第1切替弁	全閉確認	原子炉補助建屋 T.P.10.3m	手動操作	Bヘッダ 供給負荷																																																																																																																																																															
㉖	B-充てんポンプ、電動機補機冷却水B供給ライン第2切替弁	全閉確認	原子炉補助建屋 T.P.10.3m	手動操作	Bヘッダ 供給負荷																																																																																																																																																															

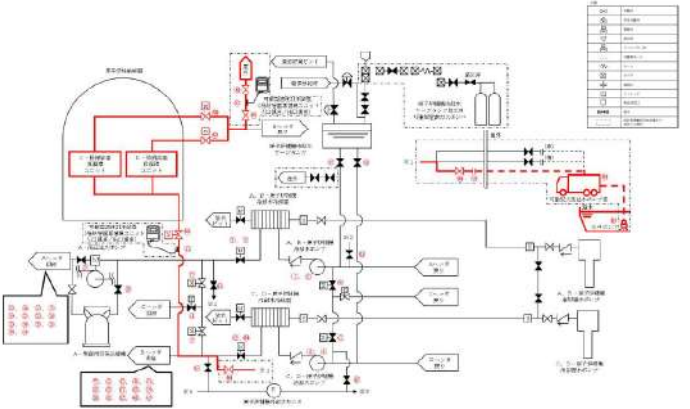

赤字：設備、運用又は体制の相違（設計方針の相違）  
 青字：記載箇所又は記載内容の相違（記載方針の相違）  
 緑字：記載表現、設備名称の相違（実質的な相違なし）

大飯発電所 3 / 4 号炉	泊発電所 3 号炉	相違理由																																																
	<table border="1"> <tr> <td>㉔</td> <td>C、D-C/V 再循環ユニット補機冷却水入口 C/V 外側隔離弁</td> <td>全閉→全開</td> <td>中央制御室</td> <td>操作器操作</td> <td>交流電源</td> </tr> <tr> <td>㉕</td> <td>C-C/V 再循環ユニット補機冷却水出口 C/V 外側隔離弁</td> <td>全閉→全開</td> <td>中央制御室</td> <td>操作器操作</td> <td>交流電源</td> </tr> <tr> <td>㉖</td> <td>D-C/V 再循環ユニット補機冷却水出口 C/V 外側隔離弁</td> <td>全閉→全開</td> <td>中央制御室</td> <td>操作器操作</td> <td>交流電源</td> </tr> <tr> <td>㉗</td> <td>原子炉補機冷却水屋内接続用ライン止め弁 (SA 対策)</td> <td>全閉→全開</td> <td>原子炉補助建屋 T. P. 10. 3m</td> <td>手動操作</td> <td>—</td> </tr> <tr> <td>㉘</td> <td>D-原子炉補機冷却水冷却器出口海水供給ライン止め弁 (SA 対策) *</td> <td>全閉→全開</td> <td>周辺補機棟 T. P. 2. 3m</td> <td>手動操作</td> <td>—</td> </tr> <tr> <td>㉙</td> <td>D-原子炉補機冷却水冷却器補機冷却水出口弁</td> <td>全開→閉ロック</td> <td>中央制御室</td> <td>操作器操作</td> <td>交流電源</td> </tr> <tr> <td>㉚</td> <td>C、D-格納容器再循環ユニット補機冷却水排水ライン止め弁 (SA 対策)</td> <td>全閉→全開</td> <td>周辺補機棟 T. P. 17. 8m</td> <td>手動操作</td> <td>—</td> </tr> <tr> <td>㉛</td> <td>C、D-格納容器再循環ユニット補機冷却水排水ライン絞り弁 (SA 対策)</td> <td>全閉→調整開</td> <td>周辺補機棟 T. P. 17. 8m</td> <td>手動操作</td> <td>—</td> </tr> </table> <p>※：操作対象機器については今後の検討により変更となる可能性がある。</p>  <p>図 50-4-4 格納容器内自然対流冷却（建屋内接続口を使用する場合）</p>	㉔	C、D-C/V 再循環ユニット補機冷却水入口 C/V 外側隔離弁	全閉→全開	中央制御室	操作器操作	交流電源	㉕	C-C/V 再循環ユニット補機冷却水出口 C/V 外側隔離弁	全閉→全開	中央制御室	操作器操作	交流電源	㉖	D-C/V 再循環ユニット補機冷却水出口 C/V 外側隔離弁	全閉→全開	中央制御室	操作器操作	交流電源	㉗	原子炉補機冷却水屋内接続用ライン止め弁 (SA 対策)	全閉→全開	原子炉補助建屋 T. P. 10. 3m	手動操作	—	㉘	D-原子炉補機冷却水冷却器出口海水供給ライン止め弁 (SA 対策) *	全閉→全開	周辺補機棟 T. P. 2. 3m	手動操作	—	㉙	D-原子炉補機冷却水冷却器補機冷却水出口弁	全開→閉ロック	中央制御室	操作器操作	交流電源	㉚	C、D-格納容器再循環ユニット補機冷却水排水ライン止め弁 (SA 対策)	全閉→全開	周辺補機棟 T. P. 17. 8m	手動操作	—	㉛	C、D-格納容器再循環ユニット補機冷却水排水ライン絞り弁 (SA 対策)	全閉→調整開	周辺補機棟 T. P. 17. 8m	手動操作	—	
㉔	C、D-C/V 再循環ユニット補機冷却水入口 C/V 外側隔離弁	全閉→全開	中央制御室	操作器操作	交流電源																																													
㉕	C-C/V 再循環ユニット補機冷却水出口 C/V 外側隔離弁	全閉→全開	中央制御室	操作器操作	交流電源																																													
㉖	D-C/V 再循環ユニット補機冷却水出口 C/V 外側隔離弁	全閉→全開	中央制御室	操作器操作	交流電源																																													
㉗	原子炉補機冷却水屋内接続用ライン止め弁 (SA 対策)	全閉→全開	原子炉補助建屋 T. P. 10. 3m	手動操作	—																																													
㉘	D-原子炉補機冷却水冷却器出口海水供給ライン止め弁 (SA 対策) *	全閉→全開	周辺補機棟 T. P. 2. 3m	手動操作	—																																													
㉙	D-原子炉補機冷却水冷却器補機冷却水出口弁	全開→閉ロック	中央制御室	操作器操作	交流電源																																													
㉚	C、D-格納容器再循環ユニット補機冷却水排水ライン止め弁 (SA 対策)	全閉→全開	周辺補機棟 T. P. 17. 8m	手動操作	—																																													
㉛	C、D-格納容器再循環ユニット補機冷却水排水ライン絞り弁 (SA 対策)	全閉→調整開	周辺補機棟 T. P. 17. 8m	手動操作	—																																													

赤字：設備、運用又は体制の相違（設計方針の相違）  
 青字：記載箇所又は記載内容の相違（記載方針の相違）  
 緑字：記載表現、設備名称の相違（実質的な相違なし）

第50条 原子炉格納容器の過圧破損を防止するための設備

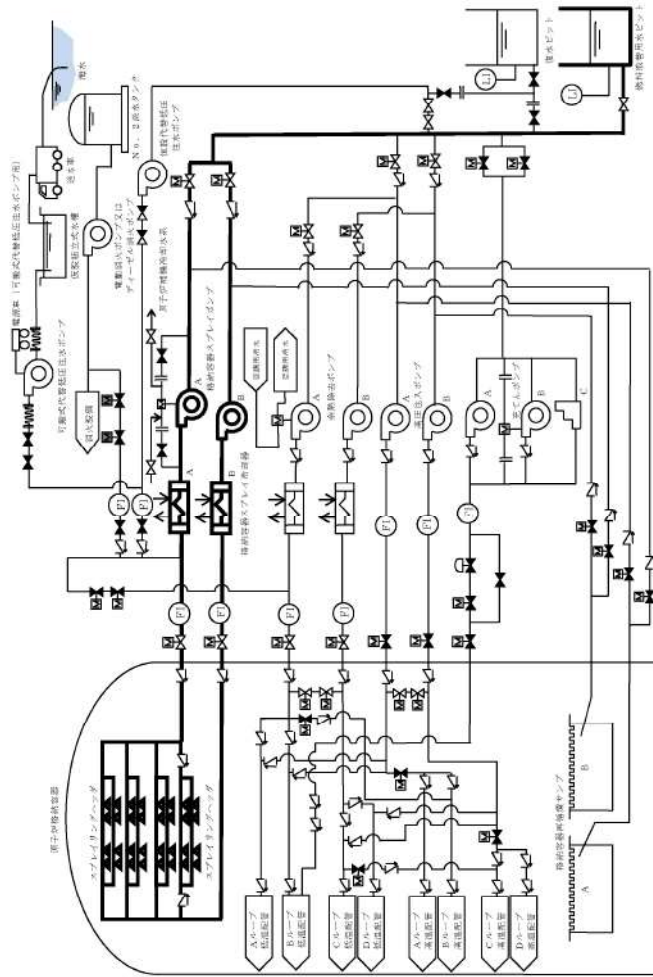
大飯発電所3/4号炉	泊発電所3号炉	相違理由
 <p style="text-align: center;">原子炉格納容器の加圧破損を防止するための設備 概略系統図（1）</p>		



赤字：設備、運用又は体制の相違（設計方針の相違）  
 青字：記載箇所又は記載内容の相違（記載方針の相違）  
 緑字：記載表現、設備名称の相違（実質的な相違なし）

第50条 原子炉格納容器の過圧破損を防止するための設備

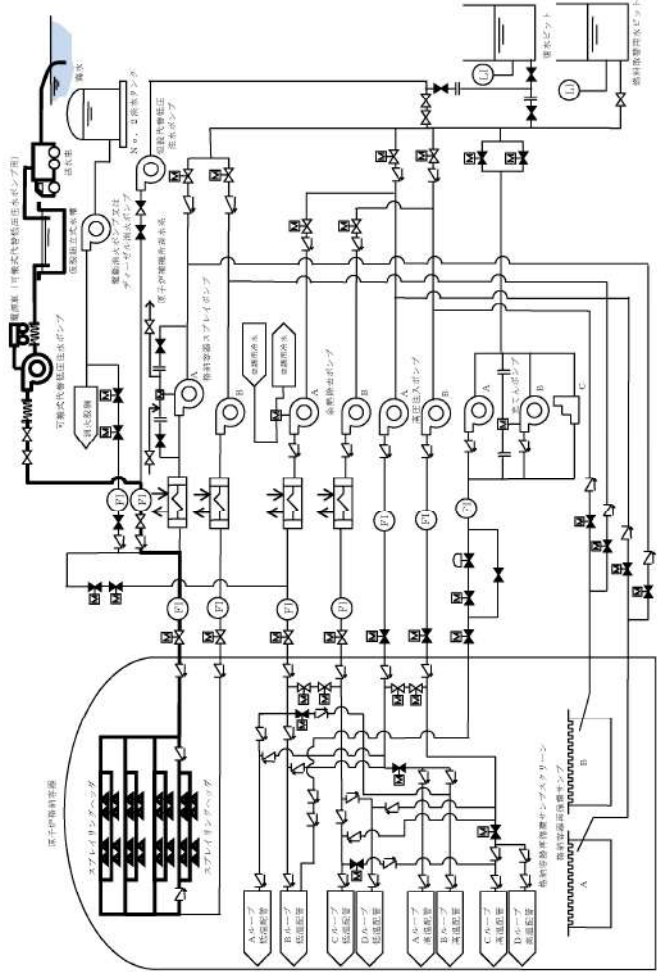
大飯発電所3/4号炉	泊発電所3号炉	相違理由
 <p style="text-align: center;">原子炉格納容器の加圧破損を防止するための設備 概略系統図(4)</p>		

泊発電所3号炉 SA基準適合性 比較表

赤字：設備、運用又は体制の相違（設計方針の相違）  
 青字：記載箇所又は記載内容の相違（記載方針の相違）  
 緑字：記載表現、設備名称の相違（実質的な相違なし）

第50条 原子炉格納容器の過圧破損を防止するための設備

大飯発電所3 / 4号炉	泊発電所3号炉	相違理由
<p>50-6 容量設定根拠 3号炉</p>	<p>50-5 容量設定根拠</p>	

赤字：設備、運用又は体制の相違（設計方針の相違）  
 青字：記載箇所又は記載内容の相違（記載方針の相違）  
 緑字：記載表現、設備名称の相違（実質的な相違なし）

第50条 原子炉格納容器の過圧破損を防止するための設備

大飯発電所3/4号炉	泊発電所3号炉	相違理由
<p>水源評価結果について（全交流動力電源喪失）</p> <p>水源に関する評価（蒸気発生器注水）</p> <p>重要事故シーケンス【全交流動力電源喪失+原子炉補機冷却機能喪失+RCPシールLOCA】</p> <p>○ 水源</p> <p>・復水ピット： <input type="text"/> m<sup>3</sup>（有効水量）</p> <p>○ 水使用パターン：</p> <p>復水ピット枯渇時間の評価に用いる蒸気発生器（SG）への必要注水量を以下に示す。</p> <p>【必要注水量内訳】 注水温度 <input type="text"/> C</p> <p>① 出力運転状態から高温停止状態までの顕熱除去：<input type="text"/> m<sup>3</sup>                  （原子炉トリップ遅れ、燃料及び1次冷却材蓄積熱量他）</p> <p>② 高温停止状態から冷却維持温度（<input type="text"/> C）までの顕熱除去：<input type="text"/> m<sup>3</sup>                  （1次冷却材及び蒸気発生器保有水等の顕熱）</p> <p>③ 蒸気発生器水位回復：<input type="text"/> m<sup>3</sup></p> <p>上記①～③の合計：<input type="text"/> m<sup>3</sup></p> <p>④ 崩壊熱除去：<input type="text"/> m<sup>3</sup></p> <div style="border: 2px solid black; height: 150px; width: 100%; margin: 10px 0;"></div> <p>復水ピットの水位低警報値までの水量 <input type="text"/> m<sup>3</sup>（有効水量）から、1次冷却系を出力運転状態から <input type="text"/> C一定維持まで冷却するために必要な注水量（<input type="text"/> m<sup>3</sup>）を引いた量 <input type="text"/> m<sup>3</sup>の water がなくなる時間を崩壊熱除去に応じた注水量カーブから求め、<input type="text"/> 時間</p> <div style="border: 1px solid black; padding: 5px; width: fit-content; margin: 10px auto;">枠囲みの範囲は機密に係る事項ですので公開することはできません。</div>	<p>2. 水源に関する評価（蒸気発生器注水）</p> <p>重要事故シーケンス</p> <p>【全交流動力電源喪失+原子炉補機冷却機能喪失+RCPシールLOCA】及び</p> <p>【全交流動力電源喪失+原子炉補機冷却機能喪失+RCPシールLOCAが発生しない場合】</p> <p>○ 水源</p> <p>補助給水ピット：570m<sup>3</sup>（有効水量）</p> <p>○ 水使用パターン</p> <p>補助給水ピット枯渇時間の評価に用いる蒸気発生器への必要注水量を以下に示す。</p> <p>【必要注水量内訳】 注水温度 40℃</p> <p>① 出力運転状態から高温停止状態までの顕熱除去：<input type="text"/> m<sup>3</sup>                  （原子炉トリップ遅れ、燃料及び1次冷却材蓄積熱量他）</p> <p>② 高温停止状態から冷却維持温度（170℃）までの顕熱除去：<input type="text"/> m<sup>3</sup>                  （1次冷却材及び蒸気発生器保有水量等の顕熱）</p> <p>③ 蒸気発生器水位回復：<input type="text"/> m<sup>3</sup></p> <p>上記①～③の合計：<input type="text"/> m<sup>3</sup></p> <p>④ 崩壊熱除去：<input type="text"/> m<sup>3</sup></p> <div style="text-align: center;"> </div> <p>補助給水ピットの有効水量 570m<sup>3</sup>から、1次冷却材系統を出力運転状態から170℃まで減温するために必要な給水量等（249.3m<sup>3</sup>）を引いた量（320.7m<sup>3</sup>）の水がなくなる時間を崩壊熱除去に応じた注水量カーブから求め、7.4時間後となる。</p> <p>7.4時間までに、可搬型大型送水ポンプ車による補助給水ピットへの補給を行うことにより対応可能である。</p> <p>補助給水ピットへの補給は、海から取水する。</p>	

赤字：設備、運用又は体制の相違（設計方針の相違）  
 青字：記載箇所又は記載内容の相違（記載方針の相違）  
 緑字：記載表現、設備名称の相違（実質的な相違なし）

第50条 原子炉格納容器の過圧破損を防止するための設備

大飯発電所3 / 4号炉	泊発電所3号炉	相違理由
<p>後になる。</p> <p>■時間までに、送水車による復水ピットへの補給を行うことにより対応可能である。</p> <p>復水ピットへの補給は、海から取水する。</p> <p>○ 水源評価結果</p> <p>事象発生■時間後までに、送水車による復水ピットへの補給を行うことにより対応可能である。</p> <p>■時間までに、送水車で補給が可能なのは成立性評価（所要時間）にて確認。</p> <p>■枠囲みの範囲は機密に係る事項ですので公開することはできません。</p>	<p>○水源評価結果</p> <p>事故後、7.4時間までに、可搬型大型送水ポンプ車による補助給水ピットへの補給を行うことにより、対応可能である。</p> <p>7.4時間までに、可搬型大型送水ポンプ車により補給が可能なのは成立性評価（所要時間）にて確認した。</p>	

赤字：設備、運用又は体制の相違（設計方針の相違）  
 青字：記載箇所又は記載内容の相違（記載方針の相違）  
 緑字：記載表現、設備名称の相違（実質的な相違なし）

第50条 原子炉格納容器の過圧破損を防止するための設備

大飯発電所3/4号炉	泊発電所3号炉	相違理由												
<p>7日間における水源の対応                  &lt;大破断LOCA+ECCS注入失敗+格納容器スプレイ失敗&gt;</p> <p>【格納容器注水】</p> <p>○水源                  燃料取替用水ピット：□m<sup>3</sup>（有効水量）</p> <p>○水使用パターン                  恒設代替低圧注水ポンプ：□m<sup>3</sup>/h                  事象発生後約□分（□時間）時間以降運転</p> <p>○時間評価（燃料取替用水ピット水が枯渇するまでの時間評価）                  □m<sup>3</sup>÷□m<sup>3</sup>/h=約□時間（事故後約□時間）                  （なお、原子炉格納容器への注水総量は約15.15時間までに可搬式代替低圧注水ポンプによる注水を開始し、約□時間まで注水継続する。□m<sup>3</sup>/h×□h=約□m<sup>3</sup>）</p> <p>○水源評価結果                  事象発生後約□時間までに可搬式代替低圧注水ポンプによる海水注水及び□時間までに大容量ポンプ、格納容器再循環ユニットによる格納容器内自然対流冷却に移行することにより対応可能。</p> <div data-bbox="257 826 896 1209" data-label="Diagram"> <p style="text-align: center;">系統概略図</p> </div> <div data-bbox="309 1316 873 1353" data-label="Text"> <p>枠囲みの範囲は機密に係る事項ですので公開することはできません。</p> </div>	<p style="text-align: center;">容-2(1/8)</p> <table border="1" data-bbox="1182 306 1881 443"> <thead> <tr> <th>名称</th> <th colspan="2">燃料取替用水ピット</th> </tr> </thead> <tbody> <tr> <td>容量</td> <td>m<sup>3</sup>/個</td> <td>□以上(2,000)</td> </tr> <tr> <td>最高使用圧力</td> <td>MPa</td> <td>大気圧</td> </tr> <tr> <td>最高使用温度</td> <td>℃</td> <td>95</td> </tr> </tbody> </table> <p>( )内は公称値を示す。</p> <p>計測制御系統施設のうちほう酸注入機能を有する設備、原子炉格納施設のうち圧力低減設備その他の安全設備（格納容器安全設備）及びその他発電用原子炉の附属施設（火災防護設備）のうち消火設備と兼用。</p> <p>最高使用圧力及び温度は、原子炉格納施設のうち圧力低減設備その他の安全設備（格納容器安全設備）に使用する場合は記載事項であり、重大事故等対処設備としての値。</p> <p>【設定根拠】</p> <ul style="list-style-type: none"> <li>設計基準対象施設                     <ul style="list-style-type: none"> <li>設計基準対象施設の燃料取替用水ピットの概要、容量、個数の設定根拠については、平成15年11月21日付け平成15・07・22原第25号にて認可された工事計画の参考資料1-1「設備別記載事項の設定根拠に関する説明書（原子炉冷却系統設備）」による。</li> </ul> </li> <li>その他発電用原子炉の附属施設（火災防護設備）のうち消火設備として使用する燃料取替用水ピットは、原子炉格納容器内で火災が発生した際、消火要員による消火活動が困難である場合に、原子炉格納容器内にスプレイすることにより、原子炉格納容器全体の雰囲気水を水滴で覆い消火を行うために設置する。</li> <li>重大事故等対処設備                     <ul style="list-style-type: none"> <li>重大事故等時に原子炉冷却系統施設のうち非常用炉心冷却設備その他原子炉注水設備として使用する燃料取替用水ピットは、以下の機能を有する。</li> <li>燃料取替用水ピットは、原子炉冷却材圧力バウンダリが高圧の状態であって、設計基準事故対処設備が有する原子炉の冷却機能が喪失した場合においても炉心の著しい損傷を防止するため、原子炉を冷却するために設置する。</li> </ul> </li> </ul> <div data-bbox="1355 1248 1818 1273" data-label="Text"> <p>□枠囲みの内容は機密情報に属しますので公開できません。</p> </div>	名称	燃料取替用水ピット		容量	m <sup>3</sup> /個	□以上(2,000)	最高使用圧力	MPa	大気圧	最高使用温度	℃	95	
名称	燃料取替用水ピット													
容量	m <sup>3</sup> /個	□以上(2,000)												
最高使用圧力	MPa	大気圧												
最高使用温度	℃	95												

赤字：設備、運用又は体制の相違（設計方針の相違）  
 青字：記載箇所又は記載内容の相違（記載方針の相違）  
 緑字：記載表現、設備名称の相違（実質的な相違なし）

第50条 原子炉格納容器の過圧破損を防止するための設備

大飯発電所3 / 4号炉	泊発電所3号炉	相違理由
	<p style="text-align: right;">容-2(2/8)</p> <div style="border: 1px solid black; padding: 5px;"> <p>系統構成は、電動補助給水ポンプ及びタービン動補助給水ポンプ、補助給水ピット又は主蒸気速がし弁の故障等により2次冷却系からの除熱機能が喪失した場合の1次系のフィードアンドブリードとして、燃料取替用水ピットを水源とした高圧注入ポンプは、安全注入系統により炉心へほう酸水を注水し、加圧器速がし弁を開操作することでフィードアンドブリードできる設計とする。</p> <p>これらの系統構成については、設備別記載事項の設定根拠に関する説明書別添3「技術基準規則第60条系統図」による。</p> <p>燃料取替用水ピットは、原子炉冷却材圧力バウンダリが高圧の状態であって、設計基準事故対処設備が有する原子炉の減圧機能が喪失した場合においても炉心の著しい損傷及び原子炉格納容器の破損を防止するため、原子炉冷却材圧力バウンダリを減圧するために設置する。</p> <p>系統構成は、電動補助給水ポンプ及びタービン動補助給水ポンプ、補助給水ピット又は主蒸気速がし弁の故障等により蒸気発生器2次側による炉心冷却を用いた1次冷却系統の減圧機能が喪失した場合の1次系のフィードアンドブリードとして、燃料取替用水ピットを水源とした高圧注入ポンプは、安全注入系統により炉心へほう酸水を注水し、格納容器再循環サンプ水位が再循環切替可能水位に到達後、格納容器再循環サンプを水源とした高圧注入ポンプは、再循環により炉心へほう酸水の注水を継続することで1次冷却系統をフィードアンドブリードできる設計とする。</p> <p>これらの系統構成については、設備別記載事項の設定根拠に関する説明書別添3「技術基準規則第61条系統図」による。</p> <p>燃料取替用水ピットは、原子炉冷却材圧力バウンダリが低圧の状態であって、設計基準事故対処設備が有する原子炉の冷却機能が喪失した場合においても炉心の著しい損傷及び原子炉格納容器の破損を防止するため、原子炉を冷却するために設置する。</p> </div>	

赤字：設備、運用又は体制の相違（設計方針の相違）  
 青字：記載箇所又は記載内容の相違（記載方針の相違）  
 緑字：記載表現、設備名称の相違（実質的な相違なし）

第50条 原子炉格納容器の過圧破損を防止するための設備

大飯発電所3/4号炉	泊発電所3号炉	相違理由
	<p style="text-align: center;">容-2(3/8)</p> <div style="border: 1px solid black; padding: 5px;"> <p>運転中の1次冷却材喪失事象時において余熱除去ポンプ及び高圧注入ポンプの故障等により炉心注水機能が喪失した場合、運転中の1次冷却材喪失事象時において余熱除去ポンプ若しくは高圧注入ポンプによる再循環又はB-格納容器スプレイポンプによる代替再循環で格納容器再循環サンプスクリーン閉塞の兆候が見られた場合並びに原子炉の冷却機能が喪失し、炉心の著しい損傷が発生した場合であって交流動力電源及び原子炉補機冷却機能が健全である場合の炉心注水として、燃料取替用水ビットを水源とする充てんポンプは、化学体積制御系統により炉心へ注水できる設計とする。</p> <p>運転中の1次冷却材喪失事象時において、余熱除去ポンプ及び高圧注入ポンプの故障等により炉心注水機能が喪失した場合、運転中の1次冷却材喪失事象時において、余熱除去ポンプ若しくは高圧注入ポンプによる再循環又はB-格納容器スプレイポンプによる代替再循環で格納容器再循環サンプスクリーン閉塞の兆候が見られた場合、運転停止中において、余熱除去ポンプ又は余熱除去冷却器の故障等により余熱除去設備による崩壊熱除去機能が喪失した場合並びに原子炉の冷却機能が喪失し、炉心の著しい損傷が発生した場合であって交流動力電源及び原子炉補機冷却機能が健全である場合の代替炉心注水として、燃料取替用水ビットを水源とするB-格納容器スプレイポンプは、格納容器スプレイ系統と余熱除去系統間の連絡ラインを介して炉心へ注水できる設計とする。</p> <p>運転中の1次冷却材喪失事象時において、余熱除去ポンプ及び高圧注入ポンプの故障等により炉心注水機能が喪失した場合、運転中の1次冷却材喪失事象時において、余熱除去ポンプ若しくは高圧注入ポンプによる再循環又はB-格納容器スプレイポンプによる代替再循環で格納容器再循環サンプスクリーン閉塞の兆候が見られた場合、運転中の1次冷却材喪失事象時において、全交流動力電源又は原子炉補機冷却機能が喪失した場合、運転停止中において、余熱除去ポンプ又は余熱除去冷却器の故障等により余熱除去設備による崩壊熱除去機能が喪失した場合、運転停止中において、全交流動力電源又は原子炉補機冷却機能が喪失した場合並びに原子炉の冷却機能が喪失し、炉心の著しい損傷が発生した場合の代替炉心注水として、燃料取替用水ビット又は補助給水ビットを水源とする代替格納容器スプレイポンプは、格納容器スプレイ系統と余熱除去系統間の連絡ラインを介して炉心へ注水できる設計とする。</p> </div>	

赤字：設備、運用又は体制の相違（設計方針の相違）  
 青字：記載箇所又は記載内容の相違（記載方針の相違）  
 緑字：記載表現、設備名称の相違（実質的な相違なし）

第50条 原子炉格納容器の過圧破損を防止するための設備

大飯発電所3 / 4号炉	泊発電所3号炉	相違理由
	<p style="text-align: center;">容-2(4/8)</p> <div style="border: 1px solid black; padding: 5px;"> <p>運転中の1次冷却材喪失事象時において、余熱除去ポンプ若しくは高压注入ポンプによる再循環又はB-格納容器スプレイポンプによる代替再循環で格納容器再循環サブスクリーン閉塞の兆候が見られた場合、運転停止中において余熱除去ポンプ又は余熱除去冷却器の故障等により余熱除去設備による崩壊熱除去機能が喪失した場合並びに原子炉の冷却機能が喪失し、炉心の著しい損傷が発生した場合であって交流動力電源及び原子炉補機冷却機能が健全である場合の炉心注水として、燃料取替用水ビットを水源とした高压注入ポンプは、安全注入システムにより炉心へ注水できる設計とする。</p> <p>運転中の1次冷却材喪失事象時において、全交流動力電源又は原子炉補機冷却機能が喪失した場合、運転停止中において、全交流動力電源又は原子炉補機冷却機能が喪失した場合並びに原子炉の冷却機能が喪失し、炉心の著しい損傷が発生した場合であって全交流動力電源又は原子炉補機冷却機能が喪失した場合の代替炉心注水として、燃料取替用水ビットを水源とするB-充てんポンプは、自己冷却ラインを用いることにより運転でき、化学体積制御系により炉心へ注水できる設計とする。</p> <p>炉心の著しい損傷、溶融が発生した場合において、原子炉容器に残存溶融デブリが存在する場合の格納容器スプレイとして、燃料取替用水ビットを水源とする格納容器スプレイポンプは、原子炉格納容器内上部にあるスプレイリングのスプレイノズルより注水できる設計とする。</p> <p>炉心の著しい損傷、溶融が発生した場合において、原子炉容器に残存溶融デブリが存在する場合の代替格納容器スプレイとして、燃料取替用水ビット又は補助給水ビットを水源とする代替格納容器スプレイポンプは、格納容器スプレイシステムを介して、原子炉格納容器内上部にあるスプレイリングのスプレイノズルより注水できる設計とする。</p> <p>原子炉の冷却機能が喪失し、炉心の著しい損傷が発生した場合であって交流動力電源及び原子炉補機冷却機能が健全である場合の炉心注水として、燃料取替用水ビットを水源とする余熱除去ポンプは、低圧注入システムにより炉心へ注水できる設計とする。</p> <p>これらの系統構成については、設備別記載事項の設定根拠に関する説明書別添3「技術基準規則第62条系統図」による。</p> </div>	



赤字：設備、運用又は体制の相違（設計方針の相違）  
 青字：記載箇所又は記載内容の相違（記載方針の相違）  
 緑字：記載表現、設備名称の相違（実質的な相違なし）

第50条 原子炉格納容器の過圧破損を防止するための設備

大飯発電所3 / 4号炉	泊発電所3号炉	相違理由
	<p style="text-align: center;">容-2(5/8)</p> <div style="border: 1px solid black; padding: 5px;"> <p>燃料取替用水ビットは、炉心の著しい損傷が発生した場合において原子炉格納容器の破損を防止するため、溶融し、原子炉格納容器の下部に落下した炉心を冷却するために設置する。</p> <p>系統構成は、炉心の著しい損傷が発生した場合であって交流動力電源及び原子炉補機冷却機能が健全である場合の格納容器スプレイとして、燃料取替用水ビットを水源とした格納容器スプレイポンプは、原子炉格納容器内上部にあるスプレイリングのスプレイノズルより注水し、格納容器スプレイ水が原子炉格納容器とフロア最外周部間の隙間等を通じ原子炉格納容器最下階フロアまで流下し、さらに連通管及び小扉を経由して原子炉下部キャビティへ流入することで、溶融炉心が落下するまでに原子炉下部キャビティに十分な水量を蓄水できる設計とする。</p> <p>炉心の著しい損傷が発生した場合の代替格納容器スプレイとして、燃料取替用水ビット又は補助給水ビットを水源とする代替格納容器スプレイポンプは、格納容器スプレイ系統を介して、原子炉格納容器内上部にあるスプレイリングのスプレイノズルより注水し、代替格納容器スプレイ水が原子炉格納容器とフロア最外周部間の隙間等を通じ原子炉格納容器最下階フロアまで流下し、さらに連通管及び小扉を経由して原子炉下部キャビティへ流入することで、溶融炉心が落下するまでに原子炉下部キャビティに十分な水量を蓄水できる設計とする。</p> <p>これらの系統構成については、設備別記載事項の設定根拠に関する説明書別添3「技術基準規則第66条系統図」による。</p> <p>燃料取替用水ビットは、設計基準事故の収束に必要な水源とは別に、重大事故等の収束に必要な十分な量の水を有する水源を確保することに加えて、原子炉施設には、設計基準事故対処設備及び重大事故等対処設備に対して重大事故等の収束に必要な十分な量の水を供給するために設置する。</p> <p>系統構成は、重大事故等により、蒸気発生器2次側への注水手段の水源となる補助給水ビットが枯渇又は破損した場合の代替手段である1次系のフィードアンドブリードの水源として、代替水源である非常用炉心冷却設備の燃料取替用水ビットを使用する。</p> <p>これらの系統構成については、設備別記載事項の設定根拠に関する説明書別添3「技術基準規則第71条系統図」による。</p> </div>	

赤字：設備、運用又は体制の相違（設計方針の相違）  
 青字：記載箇所又は記載内容の相違（記載方針の相違）  
 緑字：記載表現、設備名称の相違（実質的な相違なし）

第50条 原子炉格納容器の過圧破損を防止するための設備

大飯発電所3 / 4号炉	泊発電所3号炉	相違理由
	<p style="text-align: center;">容-2(6/8)</p> <div style="border: 1px solid black; padding: 10px;"> <p>重大事故等時に計測制御系統施設のうちほう酸注入機能を有する設備として使用する燃料取替用水ピットは、以下の機能を有する。</p> <p>燃料取替用水ピットは、運転時の異常な過渡変化時において原子炉の運転を緊急に停止することができない事象が発生するおそれがある場合又は当該事象が発生した場合においても炉心の著しい損傷を防止するため、原子炉冷却材圧力バウンダリ及び原子炉格納容器の健全性を維持するとともに、原子炉を未臨界に移行するために設置する。</p> <p>系統構成は、ほう酸ポンプが故障により使用できない場合のほう酸水注入として、燃料取替用水ピットを水源とした充てんポンプは、化学体積制御系統により、炉心に十分な量のほう酸水を注入できる設計とする。さらに、充てんポンプが使用できない場合のほう酸水注入として、燃料取替用水ピットを水源とした高圧注入ポンプは、ほう酸注入タンクを介して炉心に十分な量のほう酸水を注入できる設計とする。</p> <p>これらの系統構成については、設備別記載事項の設定根拠に関する説明書別添3「技術基準規則第59条系統図」による。</p> <p>重大事故等時に原子炉格納施設のうち圧力低減設備その他の安全設備として使用する燃料取替用水ピットは、以下の機能を有する。</p> <p>燃料取替用水ピットは、設計基準事故対処設備が有する原子炉格納容器内の冷却機能が喪失した場合において炉心の著しい損傷を防止するため、原子炉格納容器内の圧力及び温度を低下させるために設置する。また、炉心の著しい損傷が発生した場合において原子炉格納容器の破損を防止するため、原子炉格納容器内の圧力及び温度並びに放射性物質の濃度を低下させるために設置する。</p> </div>	

赤字：設備、運用又は体制の相違（設計方針の相違）  
 青字：記載箇所又は記載内容の相違（記載方針の相違）  
 緑字：記載表現、設備名称の相違（実質的な相違なし）

第50条 原子炉格納容器の過圧破損を防止するための設備

大飯発電所3/4号炉	泊発電所3号炉	相違理由
	<p style="text-align: center;">容-2(7/8)</p> <div style="border: 1px solid black; padding: 5px;"> <p>系統構成は、1次冷却材喪失事象時において、格納容器スプレイポンプ又は燃料取替用水ビットの故障等により原子炉格納容器内の冷却機能が喪失した場合、全交流動力電源又は原子炉補機冷却機能が喪失した場合、1次冷却材喪失事象時に格納容器スプレイポンプ又は燃料取替用水ビットの故障等により原子炉格納容器内の冷却機能が喪失し、炉心の著しい損傷が発生した場合並びに全交流動力電源又は原子炉補機冷却機能が喪失し、炉心の著しい損傷が発生した場合の代替格納容器スプレイとして、燃料取替用水ビット又は補助給水ビットを水源とする代替格納容器スプレイポンプは、格納容器スプレイ系統を介して、原子炉格納容器内上部にあるスプレイリングのスプレイノズルより原子炉格納容器内にスプレイできる設計とする。</p> <p>これらの系統構成については、設備別記載事項の設定根拠に関する説明書別添3「技術基準規則第64条系統図」による。</p> <p>燃料取替用水ビットは、炉心の著しい損傷が発生した場合において原子炉格納容器の破損を防止するため、原子炉格納容器内の圧力及び温度を低下させるために設置する。</p> <p>系統構成は、炉心の著しい損傷が発生した場合であって交流動力電源及び原子炉補機冷却機能が健全である場合の格納容器スプレイとして、燃料取替用水ビットを水源とする格納容器スプレイポンプは、原子炉格納容器内上部にあるスプレイリングのスプレイノズルより原子炉格納容器内にスプレイできる設計とする。</p> <p>炉心の著しい損傷が発生した場合の代替格納容器スプレイとして、燃料取替用水ビット又は補助給水ビットを水源とする代替格納容器スプレイポンプは、格納容器スプレイ系統を介して、原子炉格納容器内上部にあるスプレイリングのスプレイノズルより原子炉格納容器内にスプレイできる設計とする。</p> <p>これらの系統構成については、設備別記載事項の設定根拠に関する説明書別添3「技術基準規則第65条系統図」による。</p> <p>1. 容量</p> <p>設計基準対象施設のその他発電用原子炉の附属施設（火災防護設備）のうち消火設備として使用する燃料取替用水ビットの容量は、原子炉冷却系等施設としての設計基準対象施設と同仕様で設計し、<span style="border: 1px solid black; padding: 0 5px;"> </span>以上とする。</p> </div> <p style="text-align: center;"><span style="border: 1px solid black; padding: 0 5px;"> </span> 枠囲みの内容は機密情報に属しますので公開できません。</p>	

赤字：設備、運用又は体制の相違（設計方針の相違）  
 青字：記載箇所又は記載内容の相違（記載方針の相違）  
 緑字：記載表現、設備名称の相違（実質的な相違なし）

第50条 原子炉格納容器の過圧破損を防止するための設備

大飯発電所3 / 4号炉	泊発電所3号炉	相違理由
	<p style="text-align: right;">容-2(8/8)</p> <div style="border: 1px solid black; padding: 5px;"> <p>燃料取替用水ビットを重大事故等時において代替格納容器スプレイポンプ等による炉心注入の水源として使用する場合は、有効性評価において格納容器スプレイポンプによる代替再循環運転又は高圧注入ポンプによる高圧再循環運転、可搬型大型送水ポンプ車及び格納容器再循環ユニットによる格納容器内自然対流冷却へ移行可能な容量 <math>\square \text{ m}^3</math> (注1) が確認されている。</p> <p>また、燃料取替用水ビットを重大事故等時において代替格納容器スプレイポンプによる格納容器スプレイの水源として使用する場合は、有効性評価において可搬型大型送水ポンプ車による燃料取替用水ビットへの補給と合わせて、事故後24時間までに可搬型大型送水ポンプ車、格納容器再循環ユニットによる格納容器内自然対流冷却へ移行可能な容量 <math>\square \text{ m}^3</math> (注1) が確認されている。</p> <p>以上より、燃料取替用水ビットを重大事故等時に使用する場合は、<math>\square \text{ m}^3</math>/個とする。</p> <p>公称値については、要求される容量 <math>\square \text{ m}^3</math>/個を上回る<math>2,000 \text{ m}^3</math>/個とする。</p> <p>2. 最高使用圧力</p> <p>設計基準対象施設として使用する燃料取替用水ビットの最高使用圧力は、燃料取替用水ビットが大気開放であることから大気圧とする。</p> <p>燃料取替用水ビットを重大事故等時において使用する場合は、燃料取替用水ビットが大気開放であることから、設計基準対象施設と同仕様で設計し、大気圧とする。</p> <p>3. 最高使用温度</p> <p>設計基準対象施設として使用する燃料取替用水ビットの最高使用温度は、燃料取替用水ビットの通常運転温度が約<math>30^\circ\text{C}</math>であるため、これを上回る温度として<math>95^\circ\text{C}</math>とする。</p> <p>燃料取替用水ビットを重大事故等時において使用する場合は、燃料取替用水ビットの通常運転温度が約<math>30^\circ\text{C}</math>であることから、設計基準対象施設と同仕様で設計し、<math>30^\circ\text{C}</math>を上回る<math>95^\circ\text{C}</math>とする。</p> <p>(注1) 燃料取替用水ビットの有効水量</p> </div> <p style="text-align: center;"><math>\square</math> 枠囲みの内容は機密情報に属しますので公開できません。</p>	

赤字：設備、運用又は体制の相違（設計方針の相違）  
 青字：記載箇所又は記載内容の相違（記載方針の相違）  
 緑字：記載表現、設備名称の相違（実質的な相違なし）

第50条 原子炉格納容器の過圧破損を防止するための設備

大飯発電所3/4号炉	泊発電所3号炉	相違理由																																				
<table border="1" data-bbox="257 303 963 486"> <thead> <tr> <th>名称</th> <th colspan="2">恒設代替低圧注水ポンプ</th> </tr> </thead> <tbody> <tr> <td>容量<sup>(注1)</sup></td> <td>m<sup>3</sup>/h/個</td> <td>110 以上、130 以上<sup>(注2)</sup> (150<sup>(注3)</sup>)</td> </tr> <tr> <td>揚程<sup>(注1)</sup></td> <td>m</td> <td>□ 以上、□ 以上<sup>(注2)</sup> (150<sup>(注3)</sup>)</td> </tr> <tr> <td>最高使用圧力<sup>(注1)</sup></td> <td>MPa</td> <td>□</td> </tr> <tr> <td>最高使用温度<sup>(注1)</sup></td> <td>℃</td> <td>95</td> </tr> <tr> <td>原動機出力</td> <td>kW/個</td> <td>□</td> </tr> </tbody> </table> <p>(注1) 重大事故等時における使用時の値                  (注2) 原子炉格納施設のうち圧力低減設備その他の安全設備（格納容器安全設備）で使用する場合の値                  (注3) 公称値</p> <p><b>【設定根拠】</b>                  ・重大事故等対処設備                  重大事故等時に原子炉冷却系統施設のうち非常用炉心冷却設備その他原子炉注水設備として炉心注水時に使用する恒設代替低圧注水ポンプは、以下の機能を有する。</p> <p>恒設代替低圧注水ポンプは、原子炉冷却材圧力バウンダリが低圧の状態であって、設計基準事故対処設備が有する発電用原子炉の冷却機能が喪失した場合においても炉心の著しい損傷及び原子炉格納容器の破損を防止するため、発電用原子炉を冷却するために設置する。</p> <p>系統構成は、運転中の1次冷却材喪失事象時において、余熱除去ポンプ及び高圧注入ポンプの故障等により炉心注水機能が喪失した場合に燃料取替用水ビット又は復水ビットを水源とする恒設代替低圧注水ポンプより、格納容器スプレイ系統と余熱除去系統間の連絡ラインを介して原子炉へ注水することにより炉心の著しい損傷及び原子炉格納容器の破損を防止する設計とする。</p> <p>また、炉心の著しい損傷が発生した場合には、同様の運転にて熔融炉心の原子炉容器下部への落下を遅延・防止することで原子炉格納容器の損傷を防止する設計とする。</p> <p>恒設代替低圧注水ポンプは、設計基準事故の取束に必要な水源とは別に、重大事故等の取束に必要な十分な量の水を有する水源を確保することに加えて、発電用原子炉施設には、設計基準事故対処設備及び重大事故等対処設備に対して重大事故等の取束に必要と</p> <p style="border: 1px solid black; padding: 2px;">枠囲みの範囲は機密に係る事項のため公開することはできません。</p>	名称	恒設代替低圧注水ポンプ		容量 <sup>(注1)</sup>	m <sup>3</sup> /h/個	110 以上、130 以上 <sup>(注2)</sup> (150 <sup>(注3)</sup> )	揚程 <sup>(注1)</sup>	m	□ 以上、□ 以上 <sup>(注2)</sup> (150 <sup>(注3)</sup> )	最高使用圧力 <sup>(注1)</sup>	MPa	□	最高使用温度 <sup>(注1)</sup>	℃	95	原動機出力	kW/個	□	<p style="text-align: center;">容-5(1/7)</p> <table border="1" data-bbox="1164 311 1870 494"> <thead> <tr> <th>名称</th> <th colspan="2">代替格納容器スプレイポンプ</th> </tr> </thead> <tbody> <tr> <td>容量</td> <td>m<sup>3</sup>/h/個</td> <td>□ 以上、□ 以上(150)</td> </tr> <tr> <td>揚程</td> <td>m</td> <td>□ 以上、□ 以上(300)</td> </tr> <tr> <td>最高使用圧力</td> <td>MPa</td> <td>4.1</td> </tr> <tr> <td>最高使用温度</td> <td>℃</td> <td>95</td> </tr> <tr> <td>原動機出力</td> <td>kW/個</td> <td>200以上</td> </tr> </tbody> </table> <p>原子炉格納施設のうち圧力低減その他の安全設備に係るものと兼用</p> <p><b>【設定根拠】</b>                  ・重大事故等対処設備                  重大事故等時に原子炉冷却系統施設のうち非常用炉心冷却設備その他原子炉注水設備及び原子炉格納施設のうち圧力低減その他の安全設備に係るものとして使用する代替格納容器スプレイポンプは、以下の機能を有する。</p> <p>重大事故時に原子炉冷却系統施設のうち非常用炉心冷却設備として使用する代替格納容器スプレイポンプは、原子炉冷却材圧力バウンダリが低圧時に原子炉を冷却するための設備のうち、炉心を冷却し、炉心の著しい損傷及び原子炉格納容器の破損を防止するため及び、炉心の著しい損傷に至るまでの時間的余裕のない場合に対応するために設置する。</p> <p>系統構成は、燃料取替用水ビット又は補助給水ビットを水源とする代替格納容器スプレイポンプは、格納容器スプレイ系統と余熱除去系統間の連絡ラインを介して炉心へ注水できる設計とする。これらの系統構成については、設備別記載事項の設定根拠に関する説明書別添3「技術基準規則 第62条系統図」による。</p> <p>重大事故時に原子炉冷却系統施設のうち非常用炉心冷却設備として使用する代替格納容器スプレイポンプは、炉心の著しい損傷、熔融が発生した場合において、原子炉容器に残存熔融デブリが存在する場合、原子炉格納容器水振り（格納容器スプレイ）により残存熔融デブリを冷却し、原子炉格納容器の破損を防止するための設備として設置する。</p> <p>系統構成は、燃料取替用水ビット又は補助給水ビットを水源とする代替格納容器スプレイポンプは、格納容器スプレイ系統を介して、原子炉格納容器内上部にあるスプレイリングのスプレイノズルより注水できる設計とする。これらの系統構成については、設備別記載事項</p> <p style="border: 1px solid black; padding: 2px;">枠囲みの内容は機密情報に属しますので公開できません。</p>	名称	代替格納容器スプレイポンプ		容量	m <sup>3</sup> /h/個	□ 以上、□ 以上(150)	揚程	m	□ 以上、□ 以上(300)	最高使用圧力	MPa	4.1	最高使用温度	℃	95	原動機出力	kW/個	200以上	
名称	恒設代替低圧注水ポンプ																																					
容量 <sup>(注1)</sup>	m <sup>3</sup> /h/個	110 以上、130 以上 <sup>(注2)</sup> (150 <sup>(注3)</sup> )																																				
揚程 <sup>(注1)</sup>	m	□ 以上、□ 以上 <sup>(注2)</sup> (150 <sup>(注3)</sup> )																																				
最高使用圧力 <sup>(注1)</sup>	MPa	□																																				
最高使用温度 <sup>(注1)</sup>	℃	95																																				
原動機出力	kW/個	□																																				
名称	代替格納容器スプレイポンプ																																					
容量	m <sup>3</sup> /h/個	□ 以上、□ 以上(150)																																				
揚程	m	□ 以上、□ 以上(300)																																				
最高使用圧力	MPa	4.1																																				
最高使用温度	℃	95																																				
原動機出力	kW/個	200以上																																				

赤字：設備、運用又は体制の相違（設計方針の相違）  
 青字：記載箇所又は記載内容の相違（記載方針の相違）  
 緑字：記載表現、設備名称の相違（実質的な相違なし）

第50条 原子炉格納容器の過圧破損を防止するための設備

大飯発電所3/4号炉	泊発電所3号炉	相違理由
<p>なる十分な量の水を供給するために設置する。</p> <p>系統構成は、燃料取替用水ピット又は復水ピットを水源とする恒設代替低圧注水ポンプより、格納容器スプレイ系統と余熱除去系統間の連絡ラインを介して原子炉へ注水することができる設計とする。</p> <p>重大事故等時に原子炉冷却系統施設のうち非常用炉心冷却設備その他原子炉注水設備として格納容器スプレイ時に使用する恒設代替低圧注水ポンプは、以下の機能を有する。</p> <p>恒設代替低圧注水ポンプは、原子炉冷却材圧力バウンダリが低圧の状態であって、設計基準事故対処設備が有する発電用原子炉の冷却機能が喪失した場合においても炉心の著しい損傷及び原子炉格納容器の破損を防止するため、発電用原子炉を冷却するために設置する。</p> <p>系統構成は、炉心の著しい損傷、溶融が発生した場合において、原子炉容器に残存溶融デブリが存在する場合、原子炉格納容器水張り（格納容器スプレイ）により残存溶融デブリを冷却するため、燃料取替用水ピット又は復水ピットを水源とした恒設代替低圧注水ポンプにより、格納容器スプレイ系統を介して原子炉格納容器上部にあるスプレイリングのスプレイノズルからの注水により原子炉格納容器内に水を張ることで残存溶融デブリの冷却を行い、原子炉格納容器の破損を防止する設計とする。</p> <p>重大事故等時に原子炉格納施設のうち圧力低減設備その他の安全設備として使用する恒設代替低圧注水ポンプは、以下の機能を有する。</p> <p>恒設代替低圧注水ポンプは、設計基準事故対処設備が有する原子炉格納容器内の冷却機能が喪失した場合において炉心の著しい損傷を防止するため、原子炉格納容器内の圧力及び温度を低下させるため、また、炉心の著しい損傷が発生した場合において原子炉格納容器の破損を防止するため、原子炉格納容器内の圧力及び温度並びに放射性物質の濃度を低下させるために設置する。</p> <p>恒設代替低圧注水ポンプは、炉心の著しい損傷が発生した場合において原子炉格納容器の破損を防止するため、原子炉格納容器内の圧力及び温度を低下させるために設置する。</p> <p>これらの系統構成は、1次系冷却材喪失事象時において格納容器スプレイポンプ及び燃料取替用水ピットの故障等により原子炉格納容器内の冷却機能が喪失した場合に燃料取替用水ピット又は復水ピットを水源とする恒設代替低圧注水ポンプにより、格納容器スプレイ系統</p> <p style="border: 1px solid black; padding: 2px;">枠囲みの範囲は機密に係る事項のため公開することはできません。</p>	<p style="text-align: center;">容-5(2/7)</p> <p>の設定根拠に関する説明書別添3「技術基準規則 第62条系統図」による。</p> <p>重大事故時に原子炉冷却系統施設のうち非常用炉心冷却設備として使用する代替格納容器スプレイポンプは、原子炉の冷却機能が喪失し、炉心の著しい損傷が発生した場合に溶融炉心の原子炉格納容器下部への落下を遅延・防止することで、原子炉格納容器の破損を防止する設備として設置する。</p> <p>系統構成は、燃料取替用水ピット又は補助給水ピットを水源とする代替格納容器スプレイポンプは、格納容器スプレイ系統と余熱除去系統間の連絡ラインを介して炉心へ注水できる設計とする。これらの系統構成については、設備別記載事項の設定根拠に関する説明書別添3「技術基準規則 第62条系統図」による。</p> <p>重大事故時に原子炉格納施設のうち圧力低減設備その他の安全設備に係るものとして使用する代替格納容器スプレイポンプは、原子炉格納容器内の冷却等のための設備のうち、炉心の著しい損傷を防止するため、原子炉格納容器内の圧力及び温度を低下させるために設置する。</p> <p>系統構成は、燃料取替用水ピット又は補助給水ピットを水源とする代替格納容器スプレイポンプは、格納容器スプレイ系統を介して、原子炉格納容器内上部にあるスプレイリングのスプレイノズルより原子炉格納容器内にスプレイできる設計とする。これらの系統構成については、設備別記載事項の設定根拠に関する説明書別添3「技術基準規則 第64条系統図」による。</p> <p>重大事故時に原子炉格納施設のうち圧力低減設備その他の安全設備に係るものとして使用する代替格納容器スプレイポンプは、原子炉格納容器内の冷却等のための設備のうち、炉心の著しい損傷が発生した場合において原子炉格納容器の破損を防止するため、原子炉格納容器内の圧力及び温度並びに放射性物質の濃度を低下させるために設置する。</p> <p>系統構成は、燃料取替用水ピット又は補助給水ピットを水源とする代替格納容器スプレイポンプは、格納容器スプレイ系統を介して、原子炉格納容器内上部にあるスプレイリングのスプレイノズルより原子炉格納容器内にスプレイできる設計とする。これらの系統構成については、設備別記載事項の設定根拠に関する説明書別添3「技術基準規則 第64条系統図」による。</p>	

赤字：設備、運用又は体制の相違（設計方針の相違）  
 青字：記載箇所又は記載内容の相違（記載方針の相違）  
 緑字：記載表現、設備名称の相違（実質的な相違なし）

第50条 原子炉格納容器の過圧破損を防止するための設備

大飯発電所3/4号炉	泊発電所3号炉	相違理由
<p>を介して原子炉格納容器上部にあるスプレイリングのスプレイノズルより原子炉格納容器内にスプレイすることにより圧力及び温度を低下させる設計とする。</p> <p>また、炉心の著しい損傷が発生した場合には、同様の運転にて原子炉格納容器内の圧力及び温度並びに放射性物質の濃度を低下させる設計とする。</p> <p>恒設代替低圧注水ポンプは、炉心の著しい損傷が発生した場合において原子炉格納容器の破損を防止するため、溶融し、原子炉格納容器の下部に落下した炉心を冷却するために設置する。</p> <p>系統構成は、燃料取替用水ピット又は復水ピットを水源とする恒設代替低圧注水ポンプより、格納容器スプレイ系統を介して原子炉格納容器内上部にあるスプレイリングのスプレイノズルより原子炉格納容器内に注水し、代替格納容器スプレイ水が格納容器とフロア最外周部間の隙間等を通じ、格納容器最下階フロアまで流下し、さらに連通穴を経由して原子炉下部キャビティへ流入することで、溶融炉心が落下するまでに原子炉下部キャビティに十分な水量を蓄水することにより原子炉格納容器の破損を防止する設計とする。</p> <p>恒設代替低圧注水ポンプは、設計基準事故の収束に必要な水源とは別に、重大事故等の収束に必要な十分な量の水を有する水源を確保することに加えて、発電用原子炉施設には、設計基準事故対処設備及び重大事故等対処設備に対して重大事故等の収束に必要な十分な量の水を供給するために設置する。</p> <p>系統構成は、燃料取替用水ピット又は復水ピットを水源とする恒設代替低圧注水ポンプより、格納容器スプレイ系統を介して、原子炉格納容器上部にあるスプレイリングのスプレイノズルより原子炉格納容器内にスプレイできる設計とする。</p> <p>恒設代替低圧注水ポンプの設置個数は、1個とする。</p> <p>1. 容量</p> <p>1.1 原子炉に注水する場合の容量（110m<sup>3</sup>/h/個以上）</p> <p>原子炉冷却系統施設のうち非常用炉心冷却設備その他原子炉注水設備として炉心注水に使用する恒設代替低圧注水ポンプの容量は、炉心の著しい損傷の防止の重要事故シーケンスのうち、中破断LOCA時に高圧注入機能が喪失する事故のうち破断口が小さい場合</p> <p style="border: 1px solid black; padding: 2px;">枠囲みの範囲は機密に係る事項のため公開することはできません。</p>	<p style="text-align: center;">容-5(3/7)</p> <p>重大事故時に原子炉格納施設のうち圧力低減設備その他の安全設備に係るものとして使用する代替格納容器スプレイポンプは、原子炉格納容器の過圧破損を防止するための設備のうち、炉心の著しい損傷が発生した場合に原子炉格納容器内の圧力及び温度を低下させるために設置する。</p> <p>系統構成は、燃料取替用水ピット又は補助給水ピットを水源とする代替格納容器スプレイポンプは、格納容器スプレイ系統を介して、原子炉格納容器内上部にあるスプレイリングのスプレイノズルより原子炉格納容器内にスプレイできる設計とする。設備別記載事項の設定根拠に関する説明書別添3「技術基準規則 第65条系統図」による。</p> <p>重大事故時に原子炉格納施設のうち圧力低減設備その他の安全設備に係るものとして使用する代替格納容器スプレイポンプは、原子炉格納容器下部の溶融炉心を冷却するための設備のうち、炉心の著しい損傷が発生した場合に原子炉格納容器の下部に落下した溶融炉心を冷却するために設置する。</p> <p>系統構成は、燃料取替用水ピット又は補助給水ピットを水源とする代替格納容器スプレイポンプは、格納容器スプレイ系統を介して、原子炉格納容器内上部にあるスプレイリングのスプレイノズルより注水し、代替格納容器スプレイ水が原子炉格納容器とフロア最外周部間の隙間等を通じ、原子炉格納容器最下階フロアまで流下し、さらに小扉及び連通穴を経由して原子炉下部キャビティへ流入することで、溶融炉心が落下するまでに原子炉下部キャビティに十分な水量を蓄水できる設計とする。これらの系統構成については、設備別記載事項の設定根拠に関する説明書別添3「技術基準規則 第66条系統図」による。</p> <p>重大事故時に原子炉冷却系統施設のうち非常用炉心冷却設備及び原子炉格納施設のうち圧力低減設備その他の安全設備に係るものとして使用する代替格納容器スプレイポンプは、重大事故等の収束に必要な水の供給設備のうち、設計基準事故の収束に必要な水源とは別に、重大事故等の収束に必要な十分な量の水を有する水源を確保することに加えて、原子炉施設には、設計基準事故対処設備及び重大事故等対処設備に対して重大事故等の収束に必要な十分な量の水を供給するために設置する。</p> <p>系統構成は、代替格納容器スプレイポンプの電源は全交流動力電源が喪失した場合においても代替電源設備である空冷式非常用発電装置より、代替所内電気設備変圧器を経由して給電できる設計とする。これらの系統構成については、設備別記載事項の設定根拠に関する説明書別添3「技術基準規則 第71条系統図」による。</p>	

赤字：設備、運用又は体制の相違（設計方針の相違）  
 青字：記載箇所又は記載内容の相違（記載方針の相違）  
 緑字：記載表現、設備名称の相違（実質的な相違なし）

第50条 原子炉格納容器の過圧破損を防止するための設備

大飯発電所3/4号炉	泊発電所3号炉	相違理由
<p style="text-align: center;">大飯発電所3/4号炉</p> <div style="border: 1px solid black; padding: 5px; margin: 10px 0;"> <p>において、1次冷却材の保有水量を確保し、蒸気発生器において2次冷却材との熱交換を行い、主蒸気逃がし弁を開として2次系強制冷却を行うことで炉心崩壊熱を除去する場合に、有効性評価解析（原子炉設置変更許可申請書添付書類十）において有効性が確認されている原子炉への注水流量が110m<sup>3</sup>/hのため110m<sup>3</sup>/h/個以上とする。</p> </div> <p>1.2 原子炉格納容器内にスプレイする場合の容量（130m<sup>3</sup>/h/個以上）</p> <p>原子炉格納施設のうち圧力低減設備その他の安全設備又は、原子炉冷却系統施設のうち非常用炉心冷却設備その他原子炉注水設備として格納容器スプレイ時に使用する恒設代替低圧注水ポンプの容量は、原子炉格納容器の破損の防止の重要事故シナリオのうち、大破断LOCA+非常用炉心冷却設備注水失敗+格納容器スプレイ失敗事象などの格納容器過圧破損事象や、全交流動力電源喪失+補助給水機能喪失などの格納容器過温破損事象などにおいて、燃料取替用水ビット又は復水ビットから、ほう酸水又は淡水を原子炉格納容器内にスプレイし、原子炉格納容器内の放射性物質濃度及び圧力を低下させるために必要な容量を基に設定する。</p> <p>原子炉格納施設のうち圧力低減設備その他の安全設備又は、原子炉冷却系統施設のうち非常用炉心冷却設備その他原子炉注水設備として使用する恒設代替低圧注水ポンプの容量は、130m<sup>3</sup>/hの流量にて評価した結果、原子炉格納容器内の放射性物質濃度を低下させるために、エアロゾル除去効果が確認されているスプレイ液滴径を満足し、格納容器過圧破損事象において原子炉格納容器内の最高圧力が0.43MPaとなり、また、格納容器過温破損事象において原子炉格納容器内の最高温度が144℃となることから、重大事故対策の有効性評価解析（原子炉設置変更許可申請書添付書類十）において、放射性物質濃度を低下させ、代替最終ヒートシンクによる格納容器の除熱手段確立までの間、原子炉格納容器内の圧力を原子炉格納容器の最高使用圧力近傍で維持することが可能である流量130m<sup>3</sup>/h/個以上を当該ポンプの容量とする。</p> <p>公称値については、要求される最大容量130m<sup>3</sup>/hを上回る150m<sup>3</sup>/h/個とする。</p> <p>2. 揚程</p> <p>2.1 原子炉に注水する場合の揚程（<input type="text" value=""/>m以上）</p> <p>原子炉冷却系統施設のうち非常用炉心冷却設備その他原子炉注水設備として炉心注水時に使用する恒設代替低圧注水ポンプの揚程は、ほう酸水及び淡水を原子炉に注水する場合の水源と移送先の圧力差、静水頭、機器圧損、配管及び弁類圧損を基に設定する。</p> <div style="border: 1px solid black; padding: 2px; margin-top: 10px; text-align: center;"> <p>枠囲みの範囲は機密に係る事項のため公開することはできません。</p> </div>	<p style="text-align: center;">泊発電所3号炉</p> <p style="text-align: center;">容-5(4/7)</p> <p>代替格納容器スプレイポンプの設置個数は、1個とする。</p> <p>1. 容量</p> <p>1.1 原子炉に注入する場合の容量 <input type="text" value=""/>m<sup>3</sup>/h/個以上</p> <p>原子炉冷却系統施設のうち非常用炉心冷却設備その他原子炉注水設備として炉心注水時に使用する代替格納容器スプレイポンプの容量は、炉心の著しい損傷の防止の重要事故シナリオのうち、外部電源喪失時に非常用所内交流動力電源が喪失し、原子炉補機冷却機能の喪失及びRCPシールLOCAが発生する事故において、1次冷却材の保有水量を確保し、蒸気発生器において2次冷却材との熱交換を行い、主蒸気逃がし弁を開として2次系強制冷却を行うことで炉心崩壊熱を除去する場合に、有効性評価解析（原子炉設置変更許可申請書添付書類十）において有効性が確認されている原子炉への注水流量が<input type="text" value=""/>m<sup>3</sup>/hのため<input type="text" value=""/>m<sup>3</sup>/h/個以上とする。</p> <p>1.2 原子炉格納容器内にスプレイする場合の容量 <input type="text" value=""/>m<sup>3</sup>/h/個以上</p> <p>原子炉格納施設のうち圧力低減設備その他の安全設備又は、原子炉冷却系統施設のうち非常用炉心冷却設備その他原子炉注水設備として格納容器スプレイ時に使用する代替格納容器スプレイポンプの容量は、原子炉格納容器の破損の防止の重要事故シナリオのうち、大破断LOCA+非常用炉心冷却設備注水失敗+格納容器スプレイ失敗事象などの格納容器過圧破損事象や、全交流動力電源喪失+補助給水機能喪失などの格納容器過温破損事象などにおいて、燃料取替用水ビット又は補助給水ビットから、ほう酸水又は淡水を原子炉格納容器内にスプレイし、原子炉格納容器内の圧力を、原子炉格納容器の最高使用圧力近傍で維持するために必要な容量を基に設定する。</p> <p>原子炉格納施設のうち圧力低減設備その他の安全設備として使用する代替格納容器スプレイポンプの容量は、格納容器過圧破損事象において<input type="text" value=""/>m<sup>3</sup>/hの流量にて評価した結果、原子炉格納容器内の最高圧力が約0.36MPaとなり、また、格納容器過温破損事象においては同流量で評価した結果、原子炉格納容器内の最高温度が約141℃となることから、重大事故対策の有効性評価解析（原子炉設置変更許可申請書添付書類十）において、代替最終ヒートシンクによる格納容器の除熱手段確立までの間、原子炉格納容器内の圧力を原子炉格納容器の最高使用圧力近傍で維持することが可能である<input type="text" value=""/>m<sup>3</sup>/h/個以上とする。</p> <p>公称値については、<input type="text" value=""/>50m<sup>3</sup>/h/個とする。</p> <div style="border: 1px solid black; padding: 2px; margin-top: 10px; text-align: center;"> <p>枠囲みの内容は機密情報に属しますので公開できません。</p> </div>	



赤字：設備、運用又は体制の相違（設計方針の相違）  
 青字：記載箇所又は記載内容の相違（記載方針の相違）  
 緑字：記載表現、設備名称の相違（実質的な相違なし）

第50条 原子炉格納容器の過圧破損を防止するための設備

大飯発電所3/4号炉	泊発電所3号炉	相違理由																														
<p style="text-align: center;">大飯発電所3/4号炉</p> <div style="border: 1px solid black; padding: 5px; margin: 10px 0;"> <p>なお、1次冷却材圧力0.7MPaについては、有効性評価解析（原子炉設置変更許可申請書添付書類十）において、有効性が確認されている圧力である。</p> <table style="width: 100%; border-collapse: collapse;"> <tr> <td style="width: 60%;">水源と移送先の圧力差</td> <td style="width: 40%; text-align: center;">□</td> </tr> <tr> <td>静水頭</td> <td style="text-align: center;">□</td> </tr> <tr> <td>機器圧損</td> <td style="text-align: center;">□</td> </tr> <tr> <td>配管及び弁類圧損</td> <td style="text-align: center;">□</td> </tr> <tr> <td style="text-align: center;">合計</td> <td style="text-align: center;">□</td> </tr> </table> <p>以上より、原子炉冷却系統施設のうち非常用炉心冷却設備その他原子炉注水設備として炉心注水時に使用する恒設代替低圧注水ポンプの揚程は□以上とする。</p> <p>2.2 原子炉格納容器内にスプレイする場合の揚程（□以上）</p> <p>原子炉格納施設のうち圧力低減設備その他の安全設備又は、原子炉冷却系統施設のうち非常用炉心冷却設備その他原子炉注水設備として格納容器スプレイ時に使用する恒設代替低圧注水ポンプの揚程は、ほう酸水及び淡水を原子炉格納容器内にスプレイする場合の水源と移送先の圧力差、静水頭、機器圧損、配管及び弁類圧損を基に設定する。</p> <table style="width: 100%; border-collapse: collapse;"> <tr> <td style="width: 60%;">水源と移送先の圧力差</td> <td style="width: 40%; text-align: center;">□</td> </tr> <tr> <td>静水頭</td> <td style="text-align: center;">□</td> </tr> <tr> <td>機器圧損</td> <td style="text-align: center;">□</td> </tr> <tr> <td>配管及び弁類圧損</td> <td style="text-align: center;">□</td> </tr> <tr> <td style="text-align: center;">合計</td> <td style="text-align: center;">□</td> </tr> </table> <p>以上より、原子炉格納施設のうち圧力低減設備その他の安全設備又は、原子炉冷却系統施設のうち非常用炉心冷却設備その他原子炉注水設備として格納容器スプレイ時に使用する恒設代替低圧注水ポンプの揚程は□以上とする。</p> <p>公称値については、要求される最大揚程□を上回る150mとする。</p> <p>3. 最高使用圧力（□MPa）</p> <p>恒設代替低圧注水ポンプを重大事故等時において使用する場合の圧力は、ポンプ締切点の揚程1.55MPaおよび静水頭を考慮し、□MPaとする。</p> </div> <div style="border: 1px solid black; padding: 5px; margin-top: 10px;"> <p>枠囲みの範囲は機密に係る事項のため公開することはできません。</p> </div>	水源と移送先の圧力差	□	静水頭	□	機器圧損	□	配管及び弁類圧損	□	合計	□	水源と移送先の圧力差	□	静水頭	□	機器圧損	□	配管及び弁類圧損	□	合計	□	<p style="text-align: center;">泊発電所3号炉</p> <p style="text-align: right;">容-5(5/7)</p> <div style="border: 1px solid black; padding: 5px; margin: 10px 0;"> <p>2. 揚程</p> <p>2.1 原子炉に注入する場合の揚程 □以上</p> <p>原子炉冷却系統施設のうち非常用炉心冷却設備その他原子炉注水設備として炉心注水時に使用する代替格納容器スプレイポンプの揚程は、ほう酸水及び淡水を原子炉に注水する場合の水源と移送先の圧力差、静水頭、機器圧損、配管及び弁類圧損を基に設定する。なお、1次冷却材圧力0.7MPaについては、有効性評価解析（原子炉設置変更許可申請書添付書類十）において、有効性が確認されている圧力である。</p> <table style="width: 100%; border-collapse: collapse;"> <tr> <td style="width: 60%;">水源と移送先の圧力差</td> <td style="width: 40%; text-align: center;">約 72m</td> </tr> <tr> <td>静水頭</td> <td style="text-align: center;">約 -2m</td> </tr> <tr> <td>機器圧損</td> <td style="text-align: center;">約 □</td> </tr> <tr> <td>配管及び弁類圧損</td> <td style="text-align: center;">約 □</td> </tr> <tr> <td style="text-align: center;">合計</td> <td style="text-align: center;">約 □</td> </tr> </table> <p>以上より、原子炉冷却系統施設のうち非常用炉心冷却設備その他原子炉注水設備として使用する代替格納容器スプレイポンプの揚程は、□以上とする。</p> <p>2.2 原子炉格納容器内にスプレイする場合の揚程 □以上</p> <p>原子炉格納施設のうち圧力低減設備その他の安全設備又は、原子炉冷却系統施設のうち非常用炉心冷却設備その他原子炉注水設備として格納容器スプレイ時に使用する代替格納容器スプレイポンプの揚程は、大破断LOCA+非常用炉心冷却設備注水失敗+格納容器スプレイ失敗事象などの格納容器過圧破損事象や、全交流動力電源喪失+補助給水機能喪失などの格納容器過温破損事象などにおいて、燃料取替用ホットから、ほう酸水又は海水を原子炉格納容器内にスプレイする場合の水源と移送先の圧力差、静水頭、機器圧損、配管及び弁類圧損を基に設定する。</p> </div> <p style="text-align: center;">□ 枠囲みの内容は機密情報に属しますので公開できません。</p>	水源と移送先の圧力差	約 72m	静水頭	約 -2m	機器圧損	約 □	配管及び弁類圧損	約 □	合計	約 □	
水源と移送先の圧力差	□																															
静水頭	□																															
機器圧損	□																															
配管及び弁類圧損	□																															
合計	□																															
水源と移送先の圧力差	□																															
静水頭	□																															
機器圧損	□																															
配管及び弁類圧損	□																															
合計	□																															
水源と移送先の圧力差	約 72m																															
静水頭	約 -2m																															
機器圧損	約 □																															
配管及び弁類圧損	約 □																															
合計	約 □																															

赤字：設備、運用又は体制の相違（設計方針の相違）  
 青字：記載箇所又は記載内容の相違（記載方針の相違）  
 緑字：記載表現、設備名称の相違（実質的な相違なし）

第50条 原子炉格納容器の過圧破損を防止するための設備

大飯発電所3/4号炉	泊発電所3号炉	相違理由										
<p style="text-align: center;">大飯発電所3/4号炉</p> <div style="border: 1px solid black; padding: 5px; margin: 10px 0;"> <p>4. 最高使用温度 (95℃)                      恒設代替低圧注水ポンプを重大事故等時において使用する場合は、水源である燃料取替用水ピットの使用温度と同じ、95℃とする。</p> <p>5. 原動機出力 <input type="text"/> (W/個)                      恒設代替低圧注水ポンプの原動機出力は、流量150m<sup>3</sup>/h時の軸動力を基に設定する。                      恒設代替低圧注水ポンプの定格容量150m<sup>3</sup>/h、定格揚程150m、そのときの同ポンプの必要軸動力は、以下のとおり <input type="text"/> (W)となる。</p> <div style="border: 2px solid black; width: 150px; height: 150px; margin: 10px auto;"></div> <p style="text-align: center;">(参考文献：「ターボポンプ用語」(JIS B 0131-2002))</p> <p>以上より、恒設代替低圧注水ポンプの原動機出力は、必要軸動力112kwを上回る <input type="text"/> (W/個)とする。</p> <p style="border: 1px solid black; padding: 2px; text-align: center;">枠囲みの範囲は機密に係る事項のため公開することはできません。</p> </div>	<p style="text-align: center;">泊発電所3号炉</p> <p style="text-align: right;">容-5(6/7)</p> <table style="margin-left: auto; margin-right: auto; border-collapse: collapse;"> <tr> <td style="padding: 2px;">水源と移送先の圧力差</td> <td style="padding: 2px;">約 29m</td> </tr> <tr> <td style="padding: 2px;">静水頭</td> <td style="padding: 2px;">約 28m</td> </tr> <tr> <td style="padding: 2px;">機器圧損</td> <td style="padding: 2px;">約 <input type="text"/> m</td> </tr> <tr> <td style="padding: 2px;">配管及び弁類圧損</td> <td style="padding: 2px;">約 <input type="text"/> m</td> </tr> <tr> <td style="padding: 2px; text-align: center;">合計</td> <td style="padding: 2px;">約 <input type="text"/> m</td> </tr> </table> <p>以上より、原子炉格納施設のうち圧力低減設備その他の安全設備として使用する代替格納容器スプレイポンプの揚程は <input type="text"/> m以上とする。</p> <p>公称値については、定格流量である150m<sup>3</sup>/hの時の揚程である300mとする。</p> <p>3. 最高使用圧力                      代替格納容器スプレイポンプの最高使用圧力は、締切点の揚程から、これを上回る標準的な圧力級を選定する。                      代替格納容器スプレイポンプ締切点の揚程が約380m (=約3.7MPa) となることから、これを上回る圧力級として、4.1MPaを選定する。                      以上より、代替格納容器スプレイポンプの最高使用圧力は4.1MPaとする。</p> <p>4. 最高使用温度                      代替格納容器スプレイポンプを重大事故等時において使用する場合は、水源である燃料取替用水ピットの使用温度と同じ95℃とする。</p> <p>5. 原動機出力                      代替格納容器スプレイポンプの原動機出力は、定格運転時の軸動力を基に設定する。                      代替格納容器スプレイポンプの定格流量が150m<sup>3</sup>/h、揚程が300m、そのときの同ポンプの必要軸動力は、以下のとおり <input type="text"/> (W)となる。</p> <p style="text-align: center;"><input type="text"/> 枠囲みの内容は機密情報に属しますので公開できません。</p>	水源と移送先の圧力差	約 29m	静水頭	約 28m	機器圧損	約 <input type="text"/> m	配管及び弁類圧損	約 <input type="text"/> m	合計	約 <input type="text"/> m	
水源と移送先の圧力差	約 29m											
静水頭	約 28m											
機器圧損	約 <input type="text"/> m											
配管及び弁類圧損	約 <input type="text"/> m											
合計	約 <input type="text"/> m											

赤字：設備、運用又は体制の相違（設計方針の相違）  
 青字：記載箇所又は記載内容の相違（記載方針の相違）  
 緑字：記載表現、設備名称の相違（実質的な相違なし）

泊発電所3号炉 SA基準適合性 比較表

第50条 原子炉格納容器の過圧破損を防止するための設備

大飯発電所3/4号炉	泊発電所3号炉	相違理由
	<p style="text-align: right;">容-5(7/7)</p> <div style="border: 1px solid black; padding: 10px; margin: 10px auto; width: 80%;"> <math display="block">L = 10^{-3} \times \rho \times g \times \frac{\left( \frac{Q}{3,600} \right) \times H}{\eta}</math> <math display="block">= 10^{-3} \times 1,030 \times 9.80665 \times \frac{\left( \frac{150}{3,600} \right) \times 300}{\square} = \square \text{ W}</math> <p>L：必要軸動力 (kW)            ρ：流体の密度 (kg/m<sup>3</sup>) = 1,030            g：重力加速度 (m/s<sup>2</sup>) = 9.80665            Q：ポンプ流量 (m<sup>3</sup>/h) = 150            H：ポンプ揚程 (m) = 300            η：ポンプ効率 = <input style="width: 30px;" type="text"/></p> <p>(参考文献：「ターボポンプ用語」(JIS B 0131-2002))</p> <p>以上より、代替格納容器スプレイポンプの原動機出力は、必要軸動力 <input style="width: 30px;" type="text"/> kWを上回る200kW/個とする。</p> </div> <p style="text-align: center; margin-top: 20px;"><input style="width: 30px;" type="text"/> 枠囲みの内容は機密情報に属しますので公開できません。</p>	



赤字：設備、運用又は体制の相違（設計方針の相違）  
 青字：記載箇所又は記載内容の相違（記載方針の相違）  
 緑字：記載表現、設備名称の相違（実質的な相違なし）

第50条 原子炉格納容器の過圧破損を防止するための設備

大飯発電所3/4号炉	泊発電所3号炉	相違理由
<p style="text-align: center;">大飯発電所3/4号炉</p> <div style="border: 1px solid black; padding: 5px; margin: 10px 0;"> <p>大容量ポンプは、設計基準対象施設が有する原子炉格納容器内の冷却機能が喪失した場合において炉心の著しい損傷を防止するため、原子炉格納容器内の圧力及び温度を低下させるため、また、炉心の著しい損傷が発生した場合において原子炉格納容器の破損を防止するため、原子炉格納容器内の圧力及び温度を低下させるために設置する。</p> <p>大容量ポンプは、炉心の著しい損傷が発生した場合において原子炉格納容器の破損を防止するため、原子炉格納容器内の圧力及び温度を低下させるために設置する。</p> <p>これらの系統構成は、全交流動力電源及び原子炉補機冷却機能が喪失した場合に、A、B海水ストレーナブロー配管又はA系海水供給母管マンホールと可搬型ホースを接続し、海を水源とする大容量ポンプにより原子炉補機冷却水系統を介して、A、D格納容器再循環ユニットへ海水を直接供給し、原子炉格納容器内の自然対流冷却を行うことで原子炉格納容器内の圧力及び温度を低下させる設計とする。</p> <p>大容量ポンプは、炉心の著しい損傷が発生した場合において原子炉格納容器内における水素による爆発（以下「水素爆発」という。）による破損を防止するための設備のうち、格納容器内の水素濃度が変動する可能性のある範囲で測定するための設備として設置する。</p> <p>これらの系統構成は、全交流動力電源及び原子炉補機冷却機能が喪失した場合に、A、B海水ストレーナブロー配管又はA系海水供給母管マンホールと可搬型ホースを接続し、海を水源とする大容量ポンプによりサンプリングガスの冷却として、原子炉補機冷却水系統へ海水を直接供給できる設計とする。</p> <p>設計基準事故の収束に必要な水源とは別に、重大事故等の収束に必要な十分な量の水を有する水源を確保することに加えて、原子炉施設には、設計基準対象施設及び重大事故等対処設備に対して重大事故等の収束に必要な十分な量の水を供給するために設置する。</p> <p>系統構成は、海を水源とし、大容量ポンプは、A、B海水ストレーナブロー配管又はA系海水供給母管マンホールと可搬型ホースを接続することで、原子炉補機冷却水系統に海水を直接供給し、代替補機冷却ができる設計とする。</p> <p>なお、大容量ポンプは、定格容量 <span style="border: 1px solid black; padding: 0 5px;">  </span> m<sup>3</sup>/h/個、吐出圧力 <span style="border: 1px solid black; padding: 0 5px;">  </span> MPaの水中ポンプにて海水を取水し、うず巻式ポンプまで送水する設計とし、水中ポンプは2個設置する。</p> <p>大容量ポンプ（3・4号機共用）の保有数は、3・4号機で2セット2台、予備1台の合計3台を分散して保管する。</p> </div> <div style="border: 1px solid black; padding: 5px; margin-top: 10px; text-align: center;"> <p>枠囲みの範囲は機密に係る事項ですので公開することはできません。</p> </div>	<p style="text-align: center;">泊発電所3号炉</p> <p style="text-align: right;">容-6(2/12)</p> <div style="border: 1px solid black; padding: 5px; margin: 10px 0;"> <p>るために設置する。</p> <p>系統構成は、重大事故等対処設備（大気への拡散抑制）として、海を水源として可搬型大型送水ポンプ車にて送水し、可搬型スプレインゾルを介して燃料取扱建屋へ放水を行う設計とする。</p> <p>可搬型大型送水ポンプ車は、設計基準事故の収束に必要な水源とは別に、重大事故等の収束に必要な十分な量の水を有する水源を確保することに加えて、発電用原子炉施設には、設計基準事故対処設備及び重大事故等対処設備に対して重大事故等の収束に必要な十分な量の水を供給するために設置する。</p> <p>系統構成は、海を水源とする可搬型大型送水ポンプ車に可搬型ホース等を取り付けることにより可搬型スプレインゾルへ送水し、使用済燃料ビットへスプレイを行う設計とする。</p> <p>重大事故等時に原子炉冷却系統施設のうち非常用炉心冷却設備その他原子炉注水設備として炉心注水時に使用する可搬型大型送水ポンプ車は、以下の機能を有する。</p> <p>可搬型大型送水ポンプ車は、原子炉冷却材圧力バウンダリが低圧の状態であって、設計基準事故対処設備が有する発電用原子炉の冷却機能が喪失した場合においても炉心の著しい損傷及び原子炉格納容器の破損を防止するため、発電用原子炉を冷却するための代替格納容器スプレイポンプ等の水源となる燃料取替用水ビット若しくは原子炉へ直接海水等を注水するために設置する。</p> <p>系統構成は、運転中の1次冷却材喪失事象時において余熱除去ポンプ及び高圧注入ポンプの故障等により炉心注入機能が喪失した場合に海を水源とする可搬型大型送水ポンプ車に可搬型ホース等を接続することで、代替格納容器スプレイポンプの水源である燃料取替用水ビットへ海水等を補給し、若しくは格納容器スプレイ系統と余熱除去系統間の連絡ラインを介して炉心へ直接注水できる設計とする。</p> <p>重大事故等時に原子炉冷却系統施設のうち非常用炉心冷却設備その他原子炉注水設備として格納容器スプレイ時に使用する可搬型大型送水ポンプ車は、以下の機能を有する。</p> <p>可搬型大型送水ポンプ車は、原子炉冷却材圧力バウンダリが低圧の状態であって、設計</p> </div>	

赤字：設備、運用又は体制の相違（設計方針の相違）  
 青字：記載箇所又は記載内容の相違（記載方針の相違）  
 緑字：記載表現、設備名称の相違（実質的な相違なし）

第50条 原子炉格納容器の過圧破損を防止するための設備

大飯発電所3/4号炉	泊発電所3号炉	相違理由																																												
<p style="text-align: center;">大飯発電所3/4号炉</p> <div style="border: 1px solid black; padding: 5px;"> <p>1. 容量</p> <p>1.1 容量 ( <math>\square</math> m<sup>3</sup>/h/個以上 ( <math>\square</math> m<sup>3</sup>/h/個) )</p> <p>大容量ポンプ（3・4号機共用）の容量は、各機器に供給する冷却海水流量を基に設定する。大容量ポンプ（3・4号機共用）が供給する冷却海水流量は、第1表に示すとおり通水流量の合計が <math>\square</math> m<sup>3</sup>/hとなる。</p> <p>以上より、大容量ポンプの容量はこれを上回る容量として、 <math>\square</math> m<sup>3</sup>/h/個とする。</p> <p style="text-align: center;">第1表 必要冷却海水流量</p> <table border="1" style="width: 100%; border-collapse: collapse;"> <thead> <tr> <th rowspan="2">機器</th> <th colspan="2">3号機</th> <th colspan="2">4号機</th> </tr> <tr> <th>設計冷却海水流量</th> <th>台数</th> <th>設計冷却海水流量</th> <th>台数</th> </tr> </thead> <tbody> <tr> <td>格納容器再循環ユニット</td> <td><math>\square</math> m<sup>3</sup>/h</td> <td>2</td> <td><math>\square</math> m<sup>3</sup>/h</td> <td>2</td> </tr> <tr> <td>高圧注入ポンプ(海水冷却)</td> <td><math>\square</math> m<sup>3</sup>/h</td> <td>1</td> <td><math>\square</math> m<sup>3</sup>/h</td> <td>1</td> </tr> <tr> <td>ガスサンプル冷却器</td> <td><math>\square</math> m<sup>3</sup>/h</td> <td>1</td> <td><math>\square</math> m<sup>3</sup>/h</td> <td>1</td> </tr> <tr> <td>冷却海水流量の合計</td> <td><math>\square</math> m<sup>3</sup>/h</td> <td></td> <td><math>\square</math> m<sup>3</sup>/h</td> <td></td> </tr> <tr> <td></td> <td></td> <td><math>\square</math> m<sup>3</sup>/h</td> <td></td> <td></td> </tr> </tbody> </table> <p>なお、公称値については、大容量ポンプに要求される最大容量 <math>\square</math> m<sup>3</sup>/h/個を満足するものとして、定格容量 <math>\square</math> m<sup>3</sup>/h/個とする。</p> <p>2. 吐出圧力 ( <math>\square</math> MPa以上 ( <math>\square</math> MPa) )</p> <p>大容量ポンプ（3・4号機共用）の吐出圧力は、再循環ユニットへの海水通水ラインの静水頭差、ライン圧力損失等を基に設定する。</p> <table border="1" style="width: 100%; border-collapse: collapse;"> <thead> <tr> <th>項目</th> <th>圧力損失 (MPa)</th> </tr> </thead> <tbody> <tr> <td>ライン損失 (大容量ポンプ～格納容器再循環ユニット出口)</td> <td><math>\square</math> (注1)</td> </tr> <tr> <td>静水頭差 (大容量ポンプ～格納容器再循環ユニット)</td> <td><math>\square</math> (注2)</td> </tr> <tr> <td>再循環ユニット出口背圧確保 (沸騰防止)</td> <td><math>\square</math> (注3)</td> </tr> <tr> <td>合計</td> <td><math>\square</math></td> </tr> </tbody> </table> <p>(注1) 配管圧損は、最大の圧損にて評価                  (注2) 大容量ポンプをE.L. <math>\square</math> mに設置した場合の評価                  (注3) 格納容器過温破損（全交流動力電源喪失＋補助給水失敗）における格納容器雰囲気温度の最高値（約 <math>\square</math> °C）が冷却水に全て伝熱すると仮定しての飽和蒸気圧力を沸騰防止圧力として適用</p> </div>	機器	3号機		4号機		設計冷却海水流量	台数	設計冷却海水流量	台数	格納容器再循環ユニット	$\square$ m <sup>3</sup> /h	2	$\square$ m <sup>3</sup> /h	2	高圧注入ポンプ(海水冷却)	$\square$ m <sup>3</sup> /h	1	$\square$ m <sup>3</sup> /h	1	ガスサンプル冷却器	$\square$ m <sup>3</sup> /h	1	$\square$ m <sup>3</sup> /h	1	冷却海水流量の合計	$\square$ m <sup>3</sup> /h		$\square$ m <sup>3</sup> /h				$\square$ m <sup>3</sup> /h			項目	圧力損失 (MPa)	ライン損失 (大容量ポンプ～格納容器再循環ユニット出口)	$\square$ (注1)	静水頭差 (大容量ポンプ～格納容器再循環ユニット)	$\square$ (注2)	再循環ユニット出口背圧確保 (沸騰防止)	$\square$ (注3)	合計	$\square$	<p style="text-align: right;">容-6(3/12)</p> <p>基準事故対処設備が有する発電用原子炉の冷却機能が喪失した場合においても炉心の著しい損傷及び原子炉格納容器の破損を防止するため、発電用原子炉を冷却するために設置する。</p> <p>系統構成は、炉心の著しい損傷、溶融が発生した場合において、原子炉に残存溶融デブリが存在する場合、格納容器水張り（格納容器スプレイ）により残存溶融デブリを冷却するため、海を水源とする可搬型大型送水ポンプ車に可搬型ホース等を取り付けることにより燃料取替用水ビットへ送水し、格納容器スプレイ系統を介して、原子炉格納容器内上部にあるスプレイングのスプレイノズルからの通水により原子炉格納容器内に水を張ることで残存溶融デブリの冷却を行い、原子炉格納容器の破損を防止する設計とする。</p> <p>重大事故等時に原子炉格納施設のうち圧力低減設備その他の安全設備として使用する可搬型大型送水ポンプ車は、以下の機能を有する。</p> <p>可搬型大型送水ポンプ車は、炉心の著しい損傷が発生した場合において原子炉格納容器の破損を防止するため、原子炉格納容器内の圧力及び温度並びに放射性物質の濃度を低下させるため燃料取替用水ビットに海水等を補給するために設置する。</p> <p>可搬型大型送水ポンプ車は、炉心の著しい損傷が発生した場合において原子炉格納容器の破損を防止するため、原子炉格納容器内の圧力及び温度を低下させるため代替格納容器スプレイポンプの水源である燃料取替用水ビットに海水等を補給するために設置する。</p> <p>これらの系統構成は、1次冷却材喪失事象において格納容器スプレイポンプの故障等により原子炉格納容器内の冷却機能が喪失し、炉心の著しい損傷が発生した場合に海を水源とする可搬型大型送水ポンプ車に可搬型ホース等を取り付けることにより燃料取替用水ビットへ送水し、格納容器スプレイ系統を介して原子炉格納容器内上部にあるスプレイングのスプレイノズルより原子炉格納容器内にスプレイすることにより圧力及び温度並びに放射性物質の濃度を低下させる設計とする。</p> <p>可搬型大型送水ポンプ車は、使用済燃料貯蔵槽からの大量の水の漏えいその他の要因により当該使用済燃料貯蔵槽の水位が異常に低下した場合において使用済燃料貯蔵槽内の燃料体等の著しい損傷の進行を緩和し、及び臨界を防止するために設置する。</p>	
機器		3号機		4号機																																										
	設計冷却海水流量	台数	設計冷却海水流量	台数																																										
格納容器再循環ユニット	$\square$ m <sup>3</sup> /h	2	$\square$ m <sup>3</sup> /h	2																																										
高圧注入ポンプ(海水冷却)	$\square$ m <sup>3</sup> /h	1	$\square$ m <sup>3</sup> /h	1																																										
ガスサンプル冷却器	$\square$ m <sup>3</sup> /h	1	$\square$ m <sup>3</sup> /h	1																																										
冷却海水流量の合計	$\square$ m <sup>3</sup> /h		$\square$ m <sup>3</sup> /h																																											
		$\square$ m <sup>3</sup> /h																																												
項目	圧力損失 (MPa)																																													
ライン損失 (大容量ポンプ～格納容器再循環ユニット出口)	$\square$ (注1)																																													
静水頭差 (大容量ポンプ～格納容器再循環ユニット)	$\square$ (注2)																																													
再循環ユニット出口背圧確保 (沸騰防止)	$\square$ (注3)																																													
合計	$\square$																																													

枠囲みの範囲は機密に係る事項ですので公開することはできません。

赤字：設備、運用又は体制の相違（設計方針の相違）  
 青字：記載箇所又は記載内容の相違（記載方針の相違）  
 緑字：記載表現、設備名称の相違（実質的な相違なし）

第50条 原子炉格納容器の過圧破損を防止するための設備

大飯発電所3/4号炉	泊発電所3号炉	相違理由
<p style="text-align: center;">大飯発電所3/4号炉</p> <div style="border: 1px solid black; padding: 10px; margin: 10px 0;"> <p>以上より、大容量ポンプ（3・4号機共用）の吐出圧力は<math>\square</math>MPa以上とする。</p> <p>なお、公称値については、大容量ポンプに要求される吐出圧力<math>\square</math>MPaを満足するものとして、定格圧力が<math>\square</math>MPaのポンプとする。</p> <p>3. 最高使用圧力（<math>\square</math>MPa）                      大容量ポンプ（3・4号機共用）を重大事故等時において使用する場合は、ポンプ吐出圧力を電氣的に<math>\square</math>MPaに制限していることから、その制限値である<math>\square</math>MPaとする。</p> <p>4. 最高使用温度（<math>\square</math>℃）                      大容量ポンプ（3・4号機共用）を重大事故等時において使用する場合は、水源である海水の温度を上回る<math>\square</math>℃とする。</p> <p>5. 原動機出力（<math>\square</math>kW）                      大容量ポンプ（3・4号機共用）の原動機出力は、定格流量点（容量：<math>\square</math>m<sup>3</sup>/h、吐出圧力：<math>\square</math>MPa）での軸動力を考慮し、<math>\square</math>kWとする。</p> </div> <div style="border: 1px solid black; padding: 5px; margin-top: 20px; text-align: center;"> <p>枠囲みの範囲は機密に係る事項ですので公開することはできません。</p> </div>	<p style="text-align: center;">泊発電所3号炉</p> <p style="text-align: right;">容-6(4/12)</p> <p>系統構成は、使用済燃料ピットから大量の水の漏えいが発生し、使用済燃料ピット水位が使用済燃料ピット出口配管下端未満かつ水位低下が継続する場合に海を水源とする可搬型大型送水ポンプ車に可搬型ホース等を取り付けることにより可搬型スプレインゾルへ送水し、使用済燃料ピット全面へスプレイすることにより使用済燃料ピット内の燃料体等の著しい損傷の進行緩和、臨界防止及び放射性物質の放出低減を行う設計とする。</p> <p>可搬型大型送水ポンプ車は原子炉補機冷却水設備への送水とそれ以外の設備への送水のために2台必要であることから、保有数は4台、故障時及び保守点検による待機除外時のバックアップ用として2台の合計6台を分散して保管する。</p> <p>1. 容量</p> <p>1.1 使用済燃料ピットへ注水する場合の容量 <math>\square</math>m<sup>3</sup>/h/個以上                      核燃料物質の取扱施設及び貯蔵施設のうち使用済燃料貯蔵槽冷却浄化設備として使用済燃料ピットへ注水する可搬型大型送水ポンプ車の容量は、使用済燃料ピット水の小規模の漏えいによる水位低下について、使用済燃料ピット入口配管からの漏えいの場合には、サイフォンブレーカの効果によりサイフォンブレーカ開口部の高さで水位低下は止まり、最も水位が低下する使用済燃料ピット出口配管からの漏えいの場合には、出口配管の高さまで水位が低下することで漏えいは止まるため、出口配管の水位から遮蔽基準値に相当する水位に到達するまでは余裕があることから、使用済燃料ピットの蒸発量<math>\square</math>m<sup>3</sup>/hを上回る容量として、<math>\square</math>m<sup>3</sup>/h/個以上とする。</p> <p>1.2 使用済燃料ピットへスプレイする場合の容量 <math>\square</math>m<sup>3</sup>/h/個以上                      核燃料物質の取扱施設及び貯蔵施設のうち使用済燃料貯蔵槽冷却浄化設備として使用済燃料ピットへスプレイする可搬型大型送水ポンプ車の容量は、使用済燃料ピットから大量の水の漏えいが発生し、可搬型代替注水設備による注水を行っても使用済燃料ピット水位が使用済燃料ピット出口配管下端未満かつ水位低下が継続する場合において、使用済燃料ピット全面にスプレイ又は大量の水を放水することにより、できる限り環境への放射性物質の放出を低減できることを添付資料21「使用済燃料貯蔵槽の冷却能力に関する説明書」にて確認しており、そのときの容量が<math>\square</math>m<sup>3</sup>/hであることから<math>\square</math>m<sup>3</sup>/h/個以上とする。</p> <p>1.3 代替炉心注水を行う場合の容量 <math>\square</math>m<sup>3</sup>/h/個以上                      原子炉冷却系統施設のうち非常用炉心冷却設備その他原子炉注水設備として炉心注水</p> <p style="text-align: center;"><math>\square</math> 枠囲みの内容は機密情報に属しますので公開できません。</p>	

赤字：設備、運用又は体制の相違（設計方針の相違）  
 青字：記載箇所又は記載内容の相違（記載方針の相違）  
 緑字：記載表現、設備名称の相違（実質的な相違なし）

第50条 原子炉格納容器の過圧破損を防止するための設備

大飯発電所3/4号炉	泊発電所3号炉	相違理由
	<p style="text-align: right;">容-6(5/12)</p> <div style="border: 1px solid black; padding: 5px;"> <p>時に海水等を原子炉へ注水する可搬型大型送水ポンプ車の容量は、可搬型大型送水ポンプ車は設計基準対象施設の機能喪失時に使用する代替格納容器スプレイポンプの代替設備であることから、燃料取替用水ピットを水源とする代替格納容器スプレイポンプの有効性評価解析において、有効性が確認されている原子炉への注入流量を確保できる流量である <math>\square</math> m<sup>3</sup>/h/個以上とする。</p> <p>1.4 燃料取替用水ピットへ補給を行う場合の容量 <math>\square</math> m<sup>3</sup>/h/個以上                      原子炉冷却系統施設のうち非常用炉心冷却設備その他原子炉注水設備として炉心注水時に代替格納容器スプレイポンプの水源となる燃料取替用水ピットへ海水等を供給する可搬型大型送水ポンプ車の容量は、燃料取替用水ピットを水源とする代替格納容器スプレイポンプの有効性評価解析において、有効性が確認されている原子炉への注入流量を確保できる流量である <math>\square</math> m<sup>3</sup>/h/個以上とする。</p> <p>1.5 代替補機冷却及び格納容器内自然対流冷却を行う場合の容量 <math>\square</math> m<sup>3</sup>/h/個以上                      原子炉冷却系統施設のうち原子炉補機冷却設備として代替補機冷却及び格納容器内自然対流冷却を行う可搬型大型送水ポンプ車の容量は、原子炉補機冷却系統を介して高圧注入ポンプ、PASS及び格納容器再循環ユニットへ海水等を送水し、各補機種の冷却及び格納容器内を自然対流冷却する設備であることから、高圧注入ポンプ、PASSの冷却及び格納容器再循環ユニットを用いた格納容器自然対流冷却を行うために必要な容量である <math>\square</math> m<sup>3</sup>/h/個以上とする。</p> <p>1.6 補助給水ピットへ補給する場合の容量 <math>\square</math> m<sup>3</sup>/h/個以上                      原子炉冷却系統施設のうち蒸気タービンの附属設備として補助給水ピットへの補給を行う可搬型大型送水ポンプ車の容量は、蒸気発生器2次側へ給水する補助給水ポンプの水源である補助給水ピットへ補給する設備であることから、補助給水ポンプの給水流量を確保できる容量である <math>\square</math> m<sup>3</sup>/h/個以上とする。</p> <p>1.7 燃料取替用水ピットへ補給する場合の容量 <math>\square</math> m<sup>3</sup>/h/個以上                      原子炉格納施設のうち圧力低減設備その他の安全設備として格納容器スプレイ時に燃料取替用水ピットへ海水等を補給する可搬型大型送水ポンプ車の容量は、可搬型大型送水ポンプ車は設計基準対象施設の機能喪失時に使用する代替格納容器スプレイポンプの水源である燃料取替用水ピットへ補給する設備であることから、代替格納容器スプレイポンプの有効性評価解析において有効性が確認されている格納容器への注水流量を確保できる容量である <math>\square</math> m<sup>3</sup>/h/個以上とする。</p> <p style="text-align: center;"><math>\square</math> 枠囲みの内容は機密情報に属しますので公開できません。</p> </div>	



赤字：設備、運用又は体制の相違（設計方針の相違）  
 青字：記載箇所又は記載内容の相違（記載方針の相違）  
 緑字：記載表現、設備名称の相違（実質的な相違なし）

泊発電所3号炉 SA基準適合性 比較表

第50条 原子炉格納容器の過圧破損を防止するための設備

大飯発電所3/4号炉	泊発電所3号炉	相違理由																								
	<p style="text-align: right;">容-6(6/12)</p> <p>公称値については、本設備は使用済燃料ピットへの注水と燃料取替用水ピットへの補給、使用済燃料ピットへの注水と補助給水ピットへの補給、若しくは代替補機冷却及び格納容器内自然対流冷却をそれぞれ1台の可搬型大型送水ポンプ車で同時に供給することがあるため、同時に供給する最大容量である代替補機冷却と格納容器自然対流冷却を行う場合の<math>\square</math> <math>\text{m}^3/\text{h}</math>を上回る<math>\square</math> <math>\text{m}^3/\text{h}</math>とする。</p> <p>2. 吐出圧力</p> <p>2.1 使用済燃料ピットへ注水する場合の吐出圧力 <math>\square</math> MPa以上</p> <p>核燃料物質の取扱施設及び貯蔵施設のうち使用済燃料貯蔵槽冷却浄化設備として使用済燃料ピットへ注水する場合の可搬型大型送水ポンプ車の吐出圧力は、海水を使用済燃料ピットへ注水する場合の水源と移送先の圧力差、静水頭、機器圧損、配管・ホース及び弁類圧損を基に、同時送水を考慮して設定する。</p> <table border="1" style="margin-left: auto; margin-right: auto;"> <tr> <td>水源と移送先の圧力差</td> <td>約</td> <td>0MPa</td> </tr> <tr> <td>静水頭</td> <td>約</td> <td>0.227MPa</td> </tr> <tr> <td>機器圧損</td> <td>約</td> <td><math>\square</math> MPa</td> </tr> <tr> <td>配管・ホース及び弁類圧損</td> <td>約</td> <td><math>\square</math> MPa</td> </tr> <tr> <td>合計</td> <td>約</td> <td><math>\square</math> MPa</td> </tr> </table> <p>以上より、核燃料物質の取扱施設及び貯蔵施設のうち使用済燃料貯蔵槽冷却浄化設備として使用済燃料ピットへ注水する場合の可搬型大型送水ポンプ車の吐出圧力は、<math>\square</math> MPa以上とする。</p> <p>2.2 使用済燃料ピットへスプレイする場合の吐出圧力 <math>\square</math> MPa以上</p> <p>核燃料物質の取扱施設及び貯蔵施設のうち使用済燃料貯蔵槽冷却浄化設備として使用済燃料ピットへスプレイする場合の可搬型大型送水ポンプ車の吐出圧力は、海水を使用済燃料ピットへスプレイする場合の水源と移送先の圧力差、静水頭、機器圧損、配管・ホース及び弁類圧損を基に設定する。</p> <table border="1" style="margin-left: auto; margin-right: auto;"> <tr> <td>水源と移送先の圧力差</td> <td>約</td> <td>0MPa</td> </tr> <tr> <td>静水頭</td> <td>約</td> <td>0.227MPa</td> </tr> <tr> <td>機器圧損（スプレイノズル）</td> <td>約</td> <td><math>\square</math> MPa</td> </tr> </table> <p style="text-align: center;"><math>\square</math> 枠囲みの内容は機密情報に属しますので公開できません。</p>	水源と移送先の圧力差	約	0MPa	静水頭	約	0.227MPa	機器圧損	約	$\square$ MPa	配管・ホース及び弁類圧損	約	$\square$ MPa	合計	約	$\square$ MPa	水源と移送先の圧力差	約	0MPa	静水頭	約	0.227MPa	機器圧損（スプレイノズル）	約	$\square$ MPa	
水源と移送先の圧力差	約	0MPa																								
静水頭	約	0.227MPa																								
機器圧損	約	$\square$ MPa																								
配管・ホース及び弁類圧損	約	$\square$ MPa																								
合計	約	$\square$ MPa																								
水源と移送先の圧力差	約	0MPa																								
静水頭	約	0.227MPa																								
機器圧損（スプレイノズル）	約	$\square$ MPa																								

赤字：設備、運用又は体制の相違（設計方針の相違）  
 青字：記載箇所又は記載内容の相違（記載方針の相違）  
 緑字：記載表現、設備名称の相違（実質的な相違なし）

大飯発電所 3 / 4 号炉	泊発電所 3 号炉	相違理由																																				
	<p style="text-align: right;">容-6(7/12)</p> <table border="1" style="margin-left: auto; margin-right: auto;"> <tr> <td>配管・ホース及び弁類圧損</td> <td>約</td> <td>□ MPa</td> </tr> <tr> <td>合計</td> <td>約</td> <td>□ MPa</td> </tr> </table> <p>以上より、核燃料物質の取扱施設及び貯蔵施設のうち使用済燃料貯蔵槽冷却浄化設備として使用済燃料ビットヘスプレイする場合の可搬型大型送水ポンプ車の吐出圧力は、□ MPa以上とする。</p> <p>2.3 代替炉心注水を行う場合の吐出圧力 □ MPa以上</p> <p>原子炉冷却系統施設のうち非常用炉心冷却設備その他原子炉注水設備として代替炉心注水を行う可搬型大型送水ポンプ車の吐出圧力は、海水を原子炉に注水する場合の水源と移送先の圧力差、静水頭、機器圧損、配管・ホース及び弁類圧損を基に設定する。</p> <table border="1" style="margin-left: auto; margin-right: auto;"> <tr> <td>水源と移送先の圧力差</td> <td>約</td> <td>0.700MPa</td> </tr> <tr> <td>静水頭</td> <td>約</td> <td>0.124MPa</td> </tr> <tr> <td>機器圧損</td> <td>約</td> <td>□ MPa</td> </tr> <tr> <td>配管・ホース及び弁類圧損</td> <td>約</td> <td>□ MPa</td> </tr> <tr> <td>合計</td> <td>約</td> <td>□ MPa</td> </tr> </table> <p>以上より、原子炉冷却系統施設のうち非常用炉心冷却設備その他原子炉注水設備として代替炉心注水を行う可搬型大型送水ポンプ車の吐出圧力は、□ MPa以上とする。</p> <p>2.4 燃料取替用水ビットへ補給する場合の吐出圧力 □ MPa以上</p> <p>原子炉冷却系統施設のうち非常用炉心冷却設備その他原子炉注水設備として燃料取替用水ビットへ補給する可搬型大型送水ポンプ車の吐出圧力は、海水を燃料取替用水ビットへ補給する場合の水源と移送先の圧力差、静水頭、機器圧損、配管・ホース及び弁類圧損を基に設定する。</p> <table border="1" style="margin-left: auto; margin-right: auto;"> <tr> <td>水源と移送先の圧力差</td> <td>約</td> <td>0MPa</td> </tr> <tr> <td>静水頭</td> <td>約</td> <td>0.295MPa</td> </tr> <tr> <td>機器圧損</td> <td>約</td> <td>□ MPa</td> </tr> <tr> <td>配管・ホース及び弁類圧損</td> <td>約</td> <td>□ MPa</td> </tr> <tr> <td>合計</td> <td>約</td> <td>□ MPa</td> </tr> </table> <p>以上より、原子炉冷却系統施設のうち非常用炉心冷却設備その他原子炉注水設備とし</p> <p style="text-align: center;">□ 枠囲みの内容は機密情報に属しますので公開できません。</p>	配管・ホース及び弁類圧損	約	□ MPa	合計	約	□ MPa	水源と移送先の圧力差	約	0.700MPa	静水頭	約	0.124MPa	機器圧損	約	□ MPa	配管・ホース及び弁類圧損	約	□ MPa	合計	約	□ MPa	水源と移送先の圧力差	約	0MPa	静水頭	約	0.295MPa	機器圧損	約	□ MPa	配管・ホース及び弁類圧損	約	□ MPa	合計	約	□ MPa	
配管・ホース及び弁類圧損	約	□ MPa																																				
合計	約	□ MPa																																				
水源と移送先の圧力差	約	0.700MPa																																				
静水頭	約	0.124MPa																																				
機器圧損	約	□ MPa																																				
配管・ホース及び弁類圧損	約	□ MPa																																				
合計	約	□ MPa																																				
水源と移送先の圧力差	約	0MPa																																				
静水頭	約	0.295MPa																																				
機器圧損	約	□ MPa																																				
配管・ホース及び弁類圧損	約	□ MPa																																				
合計	約	□ MPa																																				

大飯発電所 3 / 4 号炉	泊発電所 3 号炉	相違理由																														
	<p style="text-align: right;">容-6 (8/12)</p> <p>て燃料取替用水ビットへ補給する可搬型大型送水ポンプ車の吐出圧力は、<span style="border: 1px solid black; padding: 0 5px;">  </span>MPa以上とする。</p> <p>2.5 代替補機冷却及び格納容器内自然対流冷却を行う場合の吐出圧力 <span style="border: 1px solid black; padding: 0 5px;">  </span>MPa以上</p> <p>原子炉冷却系統施設のうち補機冷却水設備として代替補機冷却及び格納容器内自然対流冷却を行う場合の可搬型大型送水ポンプ車の吐出圧力は、海水を原子炉補機冷却水系統に送水する場合の水源と移送先の圧力差、静水頭、機器圧損、配管・ホース及び弁類圧損を基に設定する。</p> <table border="0" style="margin-left: auto; margin-right: auto;"> <tr> <td>水源と移送先の圧力差</td> <td>約</td> <td>0.275MPa</td> </tr> <tr> <td>静水頭</td> <td>約</td> <td>0.323MPa</td> </tr> <tr> <td>機器圧損</td> <td>約</td> <td><span style="border: 1px solid black; padding: 0 5px;">  </span>MPa</td> </tr> <tr> <td>配管・ホース及び弁類圧損</td> <td>約</td> <td><span style="border: 1px solid black; padding: 0 5px;">  </span>MPa</td> </tr> <tr> <td style="text-align: center;">合 計</td> <td>約</td> <td><span style="border: 1px solid black; padding: 0 5px;">  </span>MPa</td> </tr> </table> <p>以上より、原子炉冷却系統施設のうち補機冷却水設備として代替補機冷却及び格納容器内自然対流冷却を行う場合の可搬型大型送水ポンプ車の吐出圧力は、<span style="border: 1px solid black; padding: 0 5px;">  </span>MPa以上とする。</p> <p>2.6 補助給水ビットへ補給する場合の吐出圧力 <span style="border: 1px solid black; padding: 0 5px;">  </span>MPa以上</p> <p>原子炉冷却系統施設のうち、蒸気タービン附属設備として補助給水ビットへ補給する可搬型大型送水ポンプ車の吐出圧力は、海水を補助給水ビットへ補給する場合の水源と移送先の圧力差、静水頭、機器圧損、配管・ホース及び弁類圧損を基に同時送水を考慮して設定する。</p> <table border="0" style="margin-left: auto; margin-right: auto;"> <tr> <td>水源と移送先の圧力差</td> <td>約</td> <td>0MPa</td> </tr> <tr> <td>静水頭</td> <td>約</td> <td>0.190MPa</td> </tr> <tr> <td>機器圧損</td> <td>約</td> <td><span style="border: 1px solid black; padding: 0 5px;">  </span>MPa</td> </tr> <tr> <td>配管・ホース及び弁類圧損</td> <td>約</td> <td><span style="border: 1px solid black; padding: 0 5px;">  </span>MPa</td> </tr> <tr> <td style="text-align: center;">合 計</td> <td>約</td> <td><span style="border: 1px solid black; padding: 0 5px;">  </span>MPa</td> </tr> </table> <p>以上より、原子炉冷却系統施設のうち、蒸気タービン附属設備として補助給水ビットへ補給する可搬型大型送水ポンプ車の吐出圧力は、<span style="border: 1px solid black; padding: 0 5px;">  </span>MPa以上とする。</p> <p style="text-align: center;"><span style="border: 1px solid black; padding: 0 5px;">  </span> 枠囲みの内容は機密情報に属しますので公開できません。</p>	水源と移送先の圧力差	約	0.275MPa	静水頭	約	0.323MPa	機器圧損	約	<span style="border: 1px solid black; padding: 0 5px;">  </span> MPa	配管・ホース及び弁類圧損	約	<span style="border: 1px solid black; padding: 0 5px;">  </span> MPa	合 計	約	<span style="border: 1px solid black; padding: 0 5px;">  </span> MPa	水源と移送先の圧力差	約	0MPa	静水頭	約	0.190MPa	機器圧損	約	<span style="border: 1px solid black; padding: 0 5px;">  </span> MPa	配管・ホース及び弁類圧損	約	<span style="border: 1px solid black; padding: 0 5px;">  </span> MPa	合 計	約	<span style="border: 1px solid black; padding: 0 5px;">  </span> MPa	
水源と移送先の圧力差	約	0.275MPa																														
静水頭	約	0.323MPa																														
機器圧損	約	<span style="border: 1px solid black; padding: 0 5px;">  </span> MPa																														
配管・ホース及び弁類圧損	約	<span style="border: 1px solid black; padding: 0 5px;">  </span> MPa																														
合 計	約	<span style="border: 1px solid black; padding: 0 5px;">  </span> MPa																														
水源と移送先の圧力差	約	0MPa																														
静水頭	約	0.190MPa																														
機器圧損	約	<span style="border: 1px solid black; padding: 0 5px;">  </span> MPa																														
配管・ホース及び弁類圧損	約	<span style="border: 1px solid black; padding: 0 5px;">  </span> MPa																														
合 計	約	<span style="border: 1px solid black; padding: 0 5px;">  </span> MPa																														

赤字：設備、運用又は体制の相違（設計方針の相違）  
 青字：記載箇所又は記載内容の相違（記載方針の相違）  
 緑字：記載表現、設備名称の相違（実質的な相違なし）

第50条 原子炉格納容器の過圧破損を防止するための設備

大飯発電所3 / 4号炉	泊発電所3号炉	相違理由															
	<p style="text-align: right;">容-6(9/12)</p> <p>2.7 燃料取替用水ビットへ補給する場合の吐出圧力 <input type="text"/> MPa以上</p> <p>原子炉格納施設のうち圧力低減設備その他の安全設備として燃料取替用水ビットへ補給する可搬型大型送水ポンプ車の吐出圧力は、海水を燃料取替用水ビットへ補給する場合の水源と移送先の圧力差、静水頭、機器圧損、配管・ホース及び弁類圧損を基に同時送水を考慮し設定する。</p> <table border="1" style="margin-left: auto; margin-right: auto;"> <tr> <td>水源と移送先の圧力差</td> <td>約</td> <td><input type="text"/> MPa</td> </tr> <tr> <td>静水頭</td> <td>約</td> <td>0.295MPa</td> </tr> <tr> <td>機器圧損</td> <td>約</td> <td><input type="text"/> MPa</td> </tr> <tr> <td>配管・ホース及び弁類圧損</td> <td>約</td> <td><input type="text"/> MPa</td> </tr> <tr> <td>合計</td> <td>約</td> <td><input type="text"/> MPa</td> </tr> </table> <p>以上より、原子炉格納施設のうち圧力低減設備その他の安全設備として燃料取替用水ビットへ補給する可搬型大型送水ポンプ車の吐出圧力は、<input type="text"/> MPa以上とする。</p> <p>公称値については、要求される最大吐出圧力 <input type="text"/> MPaを上回る <input type="text"/> MPaのポンプとする。</p> <p>3. 最高使用圧力 <sup>(注1)</sup></p> <p>可搬型大型送水ポンプ車を重大事故等時において使用する場合の圧力は、ポンプ吐出圧力を電氣的に1.6MPaに制限していることから、その制限値である1.6MPaとする。</p> <p>4. 最高使用温度 <sup>(注1)</sup></p> <p>可搬型大型送水ポンプ車を重大事故等時において使用する場合の温度は、水源である海水の温度 <sup>(注2)</sup>が40℃を下回るため40℃とする。</p> <p>5. 原動機出力</p> <p>可搬型大型送水ポンプ車の原動機出力は、流量 <input type="text"/> m<sup>3</sup>/h時の軸動力を基に設定する。</p> <p>可搬型大型送水ポンプ車の流量が <input type="text"/> m<sup>3</sup>/h、吐出圧力が <input type="text"/> MPa、そのときの同ポンプの必要軸動力は、メーカー設定値より <input type="text"/> kW/個とする。</p> <p>(注1) 重大事故等対処設備については、重大事故等時において使用する場合の圧力及び温度を記載する。</p> <p style="text-align: center;"><input type="text"/> 枠囲みの内容は機密情報に属しますので公開できません。</p>	水源と移送先の圧力差	約	<input type="text"/> MPa	静水頭	約	0.295MPa	機器圧損	約	<input type="text"/> MPa	配管・ホース及び弁類圧損	約	<input type="text"/> MPa	合計	約	<input type="text"/> MPa	
水源と移送先の圧力差	約	<input type="text"/> MPa															
静水頭	約	0.295MPa															
機器圧損	約	<input type="text"/> MPa															
配管・ホース及び弁類圧損	約	<input type="text"/> MPa															
合計	約	<input type="text"/> MPa															

泊発電所3号炉 SA基準適合性 比較表

赤字：設備、運用又は体制の相違（設計方針の相違）  
 青字：記載箇所又は記載内容の相違（記載方針の相違）  
 緑字：記載表現、設備名称の相違（実質的な相違なし）

第50条 原子炉格納容器の過圧破損を防止するための設備

大飯発電所3 / 4号炉	泊発電所3号炉	相違理由
	<p style="text-align: center;">容-6(10/12)</p> <div style="border: 1px solid black; padding: 10px; margin: 10px auto; width: 80%;"> <p>以降の重大事故等時の最高使用圧力及び最高使用温度についても同様の記載とする。</p> <p>(注2) 海水の温度は、外気の温度である原子炉設置変更許可申請書添付書類六に示す泊発電所における最高の月平均気温である8月の約25.6℃（寿都特別地域気象観測所24.5℃、小樽特別地域気象観測所25.6℃）を下回る。</p> </div>	

赤字：設備、運用又は体制の相違（設計方針の相違）  
 青字：記載箇所又は記載内容の相違（記載方針の相違）  
 緑字：記載表現、設備名称の相違（実質的な相違なし）

第50条 原子炉格納容器の過圧破損を防止するための設備

大飯発電所3/4号炉	泊発電所3号炉	相違理由																											
	<p style="text-align: center;">容-6(11/12)</p> <p>参考 可搬型大型送水ポンプ車付属水中ポンプの揚程について</p> <p>可搬型大型送水ポンプ車は、付属の水中ポンプにて取水し、車載の送水ポンプにて送水する構造である。</p> <p>容量設定根拠で示している吐出圧力は、送水ポンプ（送水側）によるものであることから、ここでは、可搬型大型送水ポンプ車付属の水中ポンプによって各取水場所から取水し、送水ポンプに送水できることを示す。</p> <p>可搬型大型送水ポンプ車は、動力消防ポンプ車の技術上の規格を定める省令（自治省令24号）に準拠して製造されており、水中ポンプを用いず吸水（大気圧のみで水を吸い上げる）することが可能である。可搬型大型送水ポンプ車は、同省令第21条（ポンプの放水性能試験）で定める放水性能試験にて、吸水高さ3mの状態において定格容量を満足することを確認している。</p> <p>注水設備及び除熱設備として使用する可搬型大型送水ポンプ車は、取水面と送水ポンプ吸込み口の高低差が最大となる3号炉取水ビットスクリーン室から送水ポンプへ取水する時でも、付属の水中ポンプを用いることにより最大取水量を満足する設計としている。</p> <p>放水性能試験時及び水中ポンプを用いた3号炉取水ビットスクリーン室からの最大取水時の有効吸込み水頭を第1表に示す。</p> <p>第1表に示すとおり、放水性能試験における送水ポンプの有効吸込み水頭 <span style="border: 1px solid black; padding: 0 5px;"> </span> に対し、水中ポンプの定格揚程、最大取水時における取水ラインホースの圧力損失、取水面と送水ポンプ吸込み口の高低差等を考慮した場合の有効吸込み水頭は <span style="border: 1px solid black; padding: 0 5px;"> </span> であり、放水性能試験における送水ポンプの有効吸込み水頭を上回っていることから、水中ポンプから送水ポンプへの送水が可能である。</p> <p>なお、水中ポンプは、水面下約5mに吊り下げられることから引き津波を考慮しても運転必要最低水位が常に確保されるため、水中ポンプにキャビテーションを発生させることなく、送水ポンプへ送水可能である。</p> <p style="text-align: center;">第1表 取水場所で供給可能な吸込み水頭</p> <table border="1" data-bbox="1160 1106 1895 1227"> <thead> <tr> <th>取水方法</th> <th>取水場所</th> <th>取水量 [m<sup>3</sup>/h]</th> <th>取水面と送水ポンプ吸込み口の高低差 [m]</th> <th>ホースの圧力損失 [kPa]</th> <th>水中ポンプの定格揚程 [m]</th> <th>大気圧 [kPa]</th> <th>飽和蒸気圧力* [kPa]</th> <th>有効吸込み水頭 [m]</th> </tr> </thead> <tbody> <tr> <td>吸水</td> <td>-</td> <td>300</td> <td>3</td> <td><span style="border: 1px solid black; padding: 0 5px;"> </span></td> <td>-</td> <td>10.3</td> <td>0.08 (水温20℃の値)</td> <td><span style="border: 1px solid black; padding: 0 5px;"> </span></td> </tr> <tr> <td>付属水中ポンプ</td> <td>3号炉取水ビットスクリーン室</td> <td>187.8</td> <td><span style="border: 1px solid black; padding: 0 5px;"> </span></td> <td><span style="border: 1px solid black; padding: 0 5px;"> </span></td> <td>10</td> <td>10.3</td> <td>0.78 (水温40℃の値)</td> <td><span style="border: 1px solid black; padding: 0 5px;"> </span></td> </tr> </tbody> </table> <p style="font-size: small;">*放水性能試験における水温の規定はないため、安全側に飽和蒸気圧力を設定している。</p> <p style="text-align: center;"><span style="border: 1px solid black; padding: 0 5px;"> </span> 枠囲みの内容は機密情報に属しますので公開できません。</p>	取水方法	取水場所	取水量 [m <sup>3</sup> /h]	取水面と送水ポンプ吸込み口の高低差 [m]	ホースの圧力損失 [kPa]	水中ポンプの定格揚程 [m]	大気圧 [kPa]	飽和蒸気圧力* [kPa]	有効吸込み水頭 [m]	吸水	-	300	3	<span style="border: 1px solid black; padding: 0 5px;"> </span>	-	10.3	0.08 (水温20℃の値)	<span style="border: 1px solid black; padding: 0 5px;"> </span>	付属水中ポンプ	3号炉取水ビットスクリーン室	187.8	<span style="border: 1px solid black; padding: 0 5px;"> </span>	<span style="border: 1px solid black; padding: 0 5px;"> </span>	10	10.3	0.78 (水温40℃の値)	<span style="border: 1px solid black; padding: 0 5px;"> </span>	
取水方法	取水場所	取水量 [m <sup>3</sup> /h]	取水面と送水ポンプ吸込み口の高低差 [m]	ホースの圧力損失 [kPa]	水中ポンプの定格揚程 [m]	大気圧 [kPa]	飽和蒸気圧力* [kPa]	有効吸込み水頭 [m]																					
吸水	-	300	3	<span style="border: 1px solid black; padding: 0 5px;"> </span>	-	10.3	0.08 (水温20℃の値)	<span style="border: 1px solid black; padding: 0 5px;"> </span>																					
付属水中ポンプ	3号炉取水ビットスクリーン室	187.8	<span style="border: 1px solid black; padding: 0 5px;"> </span>	<span style="border: 1px solid black; padding: 0 5px;"> </span>	10	10.3	0.78 (水温40℃の値)	<span style="border: 1px solid black; padding: 0 5px;"> </span>																					

赤字：設備、運用又は体制の相違（設計方針の相違）  
 青字：記載箇所又は記載内容の相違（記載方針の相違）  
 緑字：記載表現、設備名称の相違（実質的な相違なし）

大飯発電所 3 / 4 号炉	泊発電所 3 号炉	相違理由
	<p style="text-align: right;">容-6(12/12)</p> <p style="text-align: center;">第1図 可搬型大型送水ポンプ車の3号炉取水ピットスクリーン室上部配置図</p> <p style="text-align: center;">□ 枠囲みの内容は機密情報に属しますので公開できません。</p>	

赤字：設備、運用又は体制の相違（設計方針の相違）  
 青字：記載箇所又は記載内容の相違（記載方針の相違）  
 緑字：記載表現、設備名称の相違（実質的な相違なし）

第50条 原子炉格納容器の過圧破損を防止するための設備

大飯発電所3/4号炉	泊発電所3号炉	相違理由																																																				
<table border="1" data-bbox="259 306 965 517"> <thead> <tr> <th colspan="2">名 称</th> <th colspan="2">格納容器再循環ユニット</th> </tr> </thead> <tbody> <tr> <td>容量(設計熱交換量)</td> <td>MW</td> <td colspan="2">13.0</td> </tr> <tr> <td rowspan="2">管側</td> <td>最高使用圧力</td> <td>MPa</td> <td>1.4</td> </tr> <tr> <td>最高使用温度</td> <td>℃</td> <td>175</td> </tr> <tr> <td rowspan="2">胴側</td> <td>最高使用圧力</td> <td>MPa</td> <td>—</td> </tr> <tr> <td>最高使用温度</td> <td>℃</td> <td>170</td> </tr> <tr> <td>伝 熱 面 積</td> <td>m<sup>2</sup></td> <td colspan="2">[ ]</td> </tr> </tbody> </table> <p data-bbox="271 523 465 545">( )内は公称値を示す。</p> <p data-bbox="264 584 400 606">【設 定 根 拠】</p> <ul data-bbox="271 614 441 635" style="list-style-type: none"> <li>・重大事故等対処設備</li> </ul> <p data-bbox="304 643 853 665">重大事故等時に使用する格納容器再循環ユニットは、以下の機能を有する。</p> <p data-bbox="286 703 960 810">格納容器再循環ユニットは、設計基準事故対処設備が有する最終ヒートシンクへ熱を輸送する機能が喪失した場合において炉心の著しい損傷及び原子炉格納容器の破損（炉心の著しい損傷が発生する前に生ずるものに限る。）を防止するため、最終ヒートシンクへ熱を輸送するために設置する。</p> <p data-bbox="286 818 960 991">系統構成は、海水ポンプ及び原子炉補機冷却水ポンプの故障等により最終ヒートシンクへ熱を輸送する機能が喪失した場合並びに全交流動力電源が喪失した場合における1次冷却材喪失事象時を想定し、A、B海水ストレートパイプロー配管又はA系海水供給母管マンホールと可搬型ホースを接続することで、海を水源とする大容量ポンプにより原子炉補機冷却水系統を介して、格納容器再循環ユニットへ海水を直接供給し、原子炉格納容器内の自然対流冷却により原子炉格納容器内の圧力及び温度を低下させる設計とする。</p> <p data-bbox="286 1029 960 1136">格納容器再循環ユニットは、設計基準事故対処設備が有する原子炉格納容器内の冷却機能が喪失した場合において原子炉格納容器内の圧力及び温度を低下させるため、また、炉心の著しい損傷が発生した場合において原子炉格納容器の破損を防止するため、原子炉格納容器内の圧力及び温度を低下させるために設置する。</p> <p data-bbox="286 1144 960 1198">格納容器再循環ユニットは、炉心の著しい損傷が発生した場合において原子炉格納容器の破損を防止するため、原子炉格納容器内の圧力及び温度を低下させるために設置する。</p> <p data-bbox="286 1206 960 1259">これらの系統構成は、海水ポンプを用いてA原子炉補機冷却水冷却器へ海水を通水するとともに、原子炉補機冷却水の沸騰防止のため、原子炉補機冷却水サージタンクに窒素ボンベ</p> <p data-bbox="331 1286 846 1308">枠囲みの範囲は機密に係る事項ですので公開することはできません。</p>	名 称		格納容器再循環ユニット		容量(設計熱交換量)	MW	13.0		管側	最高使用圧力	MPa	1.4	最高使用温度	℃	175	胴側	最高使用圧力	MPa	—	最高使用温度	℃	170	伝 熱 面 積	m <sup>2</sup>	[ ]		<p data-bbox="1765 233 1868 255">容-7(1/5)</p> <table border="1" data-bbox="1167 363 1877 579"> <thead> <tr> <th colspan="2">名 称</th> <th colspan="2">C、D-格納容器再循環ユニット</th> </tr> </thead> <tbody> <tr> <td>容 量</td> <td>MW/個</td> <td colspan="2">7.6</td> </tr> <tr> <td rowspan="2">管側</td> <td>最高使用圧力</td> <td>MPa</td> <td>1.4</td> </tr> <tr> <td>最高使用温度</td> <td>℃</td> <td>163</td> </tr> <tr> <td rowspan="2">胴側</td> <td>最高使用圧力</td> <td>MPa</td> <td>—</td> </tr> <tr> <td>最高使用温度</td> <td>℃</td> <td>155</td> </tr> <tr> <td>伝 熱 面 積</td> <td>m<sup>2</sup>/個</td> <td colspan="2">[ ]</td> </tr> </tbody> </table> <p data-bbox="1178 585 1350 608">( )内は公称値を示す。</p> <p data-bbox="1171 646 1308 668">【設 定 根 拠】</p> <ul data-bbox="1178 676 1330 697" style="list-style-type: none"> <li>・設計基準対象施設</li> </ul> <p data-bbox="1191 705 1877 845">格納容器再循環ユニットは、通常運転時において冷却コイルに原子炉補機冷却水を通水し、格納容器再循環ファンによる強制循環によって、原子炉格納容器内の機器、配管等からの放熱量を除去するために設計交換熱量 [ ] MWを有する設計としており、原子炉格納容器内に格納容器再循環ユニットを4個設置する。なお、格納容器再循環ユニットは、通常運転時は3個使用する。</p> <p data-bbox="1191 853 1877 960">格納容器再循環ユニット（A、B、C、D-格納容器再循環ユニット）は、制御棒駆動装置冷却ユニットとあわせて原子炉冷却材圧力バウンダリに属する配管から1次冷却材の漏えい（0.23m<sup>3</sup>/h）が生じた場合において、漏えいに伴い原子炉格納容器内に放出される蒸気を凝縮するために必要な冷却能力を有する設計とする。</p> <p data-bbox="1191 968 1877 1054">なお、原子炉格納容器内の蒸気を凝縮させ漏えいを監視する装置については、添付資料23「原子炉格納容器内の一次冷却材の漏えいを監視する装置の構成に関する説明書並びに計測範囲及び警報動作範囲に関する説明書」に示す。</p> <ul data-bbox="1178 1093 1344 1114" style="list-style-type: none"> <li>・重大事故等対処設備</li> </ul> <p data-bbox="1191 1121 1877 1176">重大事故等時に原子炉格納施設のうち圧力低減設備その他の安全設備として使用するC、D-格納容器再循環ユニットは、以下の機能を有する。</p> <p data-bbox="1191 1214 1877 1268">C、D-格納容器再循環ユニットは、設計基準事故対処設備が有する最終ヒートシンクへ熱を輸送する機能が喪失した場合において炉心の著しい損傷及び原子炉格納容器の破損（炉</p> <p data-bbox="1373 1329 1827 1351">[ ] 囲みの内容は機密情報に属しますので公開できません。</p>	名 称		C、D-格納容器再循環ユニット		容 量	MW/個	7.6		管側	最高使用圧力	MPa	1.4	最高使用温度	℃	163	胴側	最高使用圧力	MPa	—	最高使用温度	℃	155	伝 熱 面 積	m <sup>2</sup> /個	[ ]		
名 称		格納容器再循環ユニット																																																				
容量(設計熱交換量)	MW	13.0																																																				
管側	最高使用圧力	MPa	1.4																																																			
	最高使用温度	℃	175																																																			
胴側	最高使用圧力	MPa	—																																																			
	最高使用温度	℃	170																																																			
伝 熱 面 積	m <sup>2</sup>	[ ]																																																				
名 称		C、D-格納容器再循環ユニット																																																				
容 量	MW/個	7.6																																																				
管側	最高使用圧力	MPa	1.4																																																			
	最高使用温度	℃	163																																																			
胴側	最高使用圧力	MPa	—																																																			
	最高使用温度	℃	155																																																			
伝 熱 面 積	m <sup>2</sup> /個	[ ]																																																				



赤字：設備、運用又は体制の相違（設計方針の相違）  
 青字：記載箇所又は記載内容の相違（記載方針の相違）  
 緑字：記載表現、設備名称の相違（実質的な相違なし）

第50条 原子炉格納容器の過圧破損を防止するための設備

大飯発電所3/4号炉	泊発電所3号炉	相違理由
<p>(原子炉補機冷却水サージタンク加圧用)を接続して窒素加圧し、A、B原子炉補機冷却水ポンプにより格納容器再循環ユニットへ原子炉補機冷却水を通し、格納容器内自然対流冷却により原子炉格納容器内の圧力及び温度を低下させる設計とする。</p> <p>なお、全交流動力電源及び原子炉補機冷却機能が喪失し、炉心の著しい損傷が発生した場合を想定し、A、B海水ストレーナブロー配管又はA系海水供給母管マンホールと可搬型ホースで接続し、海を水源とする大容量ポンプにより原子炉補機冷却水系統を介して格納容器再循環ユニットへ海水を直接供給し、格納容器自然対流冷却により原子炉格納容器内の圧力及び温度を低下させる設計とする。</p> <p>重大事故等時の冷却は凝縮熱伝達が支配的であり、原子炉格納容器内の水蒸気の凝縮による格納容器内自然対流冷却により、圧力および温度を低減する設計とする。</p> <p>格納容器再循環ユニットは、4個設置しているもののうち重大事故等対処設備として2個(A、D格納容器再循環ユニット)を使用する。</p> <p>1. 容量（設計熱交換量）（13.0MW/個）</p> <p>格納容器再循環ユニットは、対処する事故シナシにおける原子炉格納容器内の雰囲気温度等により異なるが、原子炉格納容器内の圧力が最高使用圧力の2倍時（0.78MPa、168℃）に格納容器再循環ユニットへ原子炉補機冷却水又は海水（冷却水温度35℃）を141m<sup>3</sup>/hで通水する場合に得られる除熱量を基に容量を設定する。</p> <p>この、格納容器再循環ユニットによる重大事故等時条件下における除熱量の評価手法は、電力共同研究による実証試験により確認されているため、格納容器再循環ユニットの容量は、上記評価手法により評価された除熱量に基づき13.0MWとする。</p> <p>2. 最高使用圧力</p> <p>2.1 最高使用圧力（管側）（1.4MPa）</p> <p>格納容器再循環ユニット（管側）の圧力は、原子炉補機冷却水冷却器（胴側）の重大事故等時における使用圧力1.2MPa以上である1.4MPaとする。</p> <p>2.2 最高使用圧力（胴側）（-）</p> <p>格納容器再循環ユニット（胴側）を重大事故等時において使用する場合は、格納容器再循環ファンが停止し、格納容器再循環ユニット（胴側）にかかる圧力はわずかであるため設定しない。</p> <p>3. 最高使用温度</p>	<p style="text-align: center;">容-7(2/5)</p> <p>心の著しい損傷が発生する前に生ずるものに限る。)を防止するため、最終ヒートシンクへ熱を輸送するために設置する。</p> <p>系統構成は、原子炉補機冷却海水ポンプ及び原子炉補機冷却水ポンプの故障等により最終ヒートシンクへ熱を輸送する機能が喪失した場合並びに全交流動力電源が喪失した場合における1次冷却材喪失事象時を想定し、A、D-原子炉補機冷却水冷却器出口配管と可搬型ホースを接続し、海を水源とする可搬型大型送水ポンプ車により原子炉補機冷却水系統を介して、C、D-格納容器再循環ユニットへ海水を直接供給し、原子炉格納容器内の自然対流冷却により原子炉格納容器内の圧力及び温度を低下させる設計とする。これらの系統構成については、設備別記載事項の設定根拠に関する説明書別添3「技術基準規則 第63条系統図」による。</p> <p>C、D-格納容器再循環ユニットは、設計基準事故対処設備が有する原子炉格納容器内の冷却機能が喪失した場合において原子炉格納容器内の圧力及び温度を低下させるため、また、炉心の著しい損傷が発生した場合において原子炉格納容器の破損を防止するため、原子炉格納容器内の圧力及び温度を低下させるために設置する。</p> <p>これらの系統構成は、C、D-原子炉補機冷却海水ポンプを用いて、C、D-原子炉補機冷却水冷却器へ海水を通水するとともに、原子炉補機冷却水の沸騰防止のため、原子炉補機冷却水サージタンクに原子炉補機冷却水サージタンク加圧用可搬型窒素ガスポンプを接続して窒素加圧し、C、D-原子炉補機冷却水ポンプにより、C、D-格納容器再循環ユニットへ原子炉補機冷却水を通し、格納容器内自然対流冷却により原子炉格納容器内の圧力及び温度を低下させる設計とする。</p> <p>なお、全交流動力電源又は原子炉補機冷却機能が喪失し、炉心の著しい損傷が発生した場合を想定し、A、D-原子炉補機冷却水冷却器出口配管と可搬型ホースで接続し、海を水源とする可搬型大型送水ポンプ車により原子炉補機冷却水系統を介して、C、D-格納容器再循環ユニットへ海水を直接供給し、格納容器自然対流冷却により原子炉格納容器内の圧力及び温度を低下させる設計とする。</p> <p>C、D-格納容器再循環ユニットは、原子炉格納容器内雰囲気温度の上昇により自動動作するダクト開放機構を有し、重大事故等時において原子炉格納容器の最高使用圧力及び最高使用温度を下回る飽和温度にて確実に開放することで、C、D-格納容器再循環ユニットに通水した冷却水により、凝縮・冷却した密度の大きいガスが下部の（水位レベルより高い位置にある）ダクト開放機構から原子炉格納容器内に放出される。</p> <p>重大事故等時の冷却は凝縮熱伝達が支配的であり、原子炉格納容器内の水蒸気の凝縮による格納容器内自然対流冷却により、圧力および温度を低減する設計とする。</p>	

赤字：設備、運用又は体制の相違（設計方針の相違）  
 青字：記載箇所又は記載内容の相違（記載方針の相違）  
 緑字：記載表現、設備名称の相違（実質的な相違なし）

第50条 原子炉格納容器の過圧破損を防止するための設備

大飯発電所3 / 4号炉	泊発電所3号炉	相違理由
<div data-bbox="264 276 965 991" style="border: 1px solid black; padding: 5px;"> <p>3.1 最高使用温度（管側）（175℃） 格納容器再循環ユニット（管側）を重大事故等時において使用する場合は原子炉補機冷却水冷却器（胴側）の重大事故等時における使用温度と同じ175℃とする。</p> <p>3.2 最高使用温度（胴側）（170℃） 格納容器再循環ユニット（胴側）を重大事故等時において使用する場合は、格納容器最高使用圧力の2倍に相当する168℃に対して170℃とする。</p> <p>4. 伝熱面積 [ ] 格納容器再循環ユニットに内蔵する冷却コイルの伝熱面積は、標準的な冷却コイルの型番から、出力運転時の処理風量（3500m<sup>3</sup>/min）において容量0.735MW（設計熱交換量）を満足できるコイルを選定しており、その伝熱面積 [ ]m<sup>2</sup>以上となる。重大事故等時の除熱量は、この伝熱面積を基に評価している。</p> <p>なお、公称値については、格納容器再循環ユニットに要求される伝熱面積と同じ [ ]m<sup>2</sup>とする。</p> </div> <div data-bbox="327 1002 842 1031" style="border: 1px solid black; padding: 2px; margin-top: 10px;"> <p>枠囲みの範囲は機密に係る事項ですので公開することはできません。</p> </div>	<div data-bbox="1167 276 1877 1289" style="border: 1px solid black; padding: 5px;"> <p style="text-align: center;">容-7(3/5)</p> <p>これらの系統構成については、設備別記載事項の設定根拠に関する説明書別添3「技術基準規則 第64条系統図」による。</p> <p>C、D-格納容器再循環ユニットは、炉心の著しい損傷が発生した場合において原子炉格納容器の破損を防止するため、原子炉格納容器内の圧力及び温度を低下させるために設置する。</p> <p>これらの系統構成は、C、D-原子炉補機冷却海水ポンプを用いて、C、D-原子炉補機冷却水冷却器へ海水を通水するとともに、原子炉補機冷却水の沸騰防止のため、原子炉補機冷却水サージタンクに原子炉補機冷却水サージタンク加圧用可搬型窒素ガスポンプを接続して窒素加圧し、C、D-原子炉補機冷却ポンプにより、C、D-格納容器再循環ユニットへ原子炉補機冷却水を通水し、格納容器内自然対流冷却により原子炉格納容器内の圧力及び温度を低下させる設計とする。</p> <p>なお、全交流動力電源又は原子炉補機冷却機能が喪失し、炉心の著しい損傷が発生した場合を想定し、A、D-原子炉補機冷却水冷却器出口配管と可搬型ホースで接続し、海を水源とする可搬型大型送水ポンプ車により原子炉補機冷却水系統を介して、C、D-格納容器再循環ユニットへ海水を直接供給し、格納容器内自然対流冷却により原子炉格納容器内の圧力及び温度を低下させる設計とする。</p> <p>原子炉格納施設のうち圧力低減設備その他の安全設備として、C、D-格納容器再循環ユニットは、原子炉格納容器内雰囲気温度の上昇により自動動作するダクト開放機構を有し、重大事故等時において原子炉格納容器の最高使用圧力及び最高使用温度を下回る飽和温度にて確実に開放することで、C、D-格納容器再循環ユニットに通水した冷却水により、凝縮・冷却した密度の大きいガスが下部の（水没レベルより高い位置にある）ダクト開放機構から原子炉格納容器内に放出される。</p> <p>重大事故等時の冷却は凝縮熱伝達が支配的であり、原子炉格納容器内の水蒸気の凝縮による格納容器内自然対流冷却により、圧力および温度を低減する設計とする。</p> <p>これらの系統構成については、設備別記載事項の設定根拠に関する説明書別添3「技術基準規則 第65条系統図」による。</p> <p>格納容器再循環ユニットは、4個設置しているもののうち重大事故等対処設備として2個（C、D-格納容器再循環ユニット）を使用する。</p> <p>1. 容量 重大事故等時に、C、D-格納容器再循環ユニットに求められる性能は、原子炉格納容器</p> </div>	

赤字：設備、運用又は体制の相違（設計方針の相違）  
 青字：記載箇所又は記載内容の相違（記載方針の相違）  
 緑字：記載表現、設備名称の相違（実質的な相違なし）

第50条 原子炉格納容器の過圧破損を防止するための設備

大飯発電所3/4号炉	泊発電所3号炉	相違理由
	<p style="text-align: center;">容-7(4/5)</p> <div style="border: 1px solid black; padding: 5px;"> <p>内に放出されるエネルギーを継続的に原子炉格納容器外に排出して、原子炉格納容器内圧力及び温度を過度に上昇させず、原子炉格納容器の健全性を維持することである。</p> <p>C、D-格納容器再循環ユニットの除熱量は、対処する事故シーケンスにおける原子炉格納容器内の雰囲気温度等により異なるが、重大事故等時の使用状態での除熱量を踏まえ、有効性評価の判断基準である原子炉格納容器の最高使用圧力の2倍時での飽和蒸気での解析条件を基に設定する。</p> <p>C、D-格納容器再循環ユニットの容量は、原子炉格納容器内の最高使用圧力の2倍時（0.566MPa、155℃）に原子炉補機冷却水（設計温度32℃）又は海水（設計温度26℃）を包括する冷却水温度32℃を通常運転時の定格流量である <span style="border: 1px solid black; padding: 0 2px;">□</span> m<sup>3</sup>/hで通水する場合に得られる除熱量を、電力共同研究による実証試験により確認された評価手法により評価し7.6MW/個とする。</p> <p>電力共同研究による実証試験の詳細については、添付資料36「原子炉格納施設の設計条件に関する説明書」に示す。</p> <p>2. 最高使用圧力</p> <p>2.1 最高使用圧力（管側）</p> <p>C、D-格納容器再循環ユニット（管側）を重大事故等時において使用する場合の圧力は、原子炉補機冷却水冷却器（管側）の重大事故等時における使用圧力と同じ1.4MPaとする。</p> <p>2.2 最高使用圧力（胴側）</p> <p>C、D-格納容器再循環ユニット（胴側）を重大事故等時において使用する場合の圧力は、格納容器再循環ファンが停止した状態であり、格納容器再循環ユニットの内外面に有意な差圧は発生しないため設定しない。</p> <p>3. 最高使用温度</p> <p>3.1 最高使用温度（管側）</p> <p>C、D-格納容器再循環ユニット（管側）を重大事故等時において使用する場合の温度は、C、D-原子炉補機冷却水冷却器（胴側）の重大事故等時における使用温度と同じ163℃とする。</p> <p>3.2 最高使用温度（胴側）</p> <p>C、D-格納容器再循環ユニット（胴側）を重大事故等時において使用する場合の温度は、原子炉格納容器の重大事故等時における使用温度141℃を上回る155℃とする。</p> </div> <p style="text-align: center;"> <span style="border: 1px solid black; display: inline-block; width: 1em; height: 1em; vertical-align: middle;"></span> 枠囲みの内容は機密情報に属しますので公開できません。枠         </p>	

赤字：設備、運用又は体制の相違（設計方針の相違）  
 青字：記載箇所又は記載内容の相違（記載方針の相違）  
 緑字：記載表現、設備名称の相違（実質的な相違なし）

第50条 原子炉格納容器の過圧破損を防止するための設備

大飯発電所3 / 4号炉	泊発電所3号炉	相違理由
	<p style="text-align: right;">容-7(5/5)</p> <div style="border: 1px solid black; padding: 10px;"> <p>4. 伝熱面積</p> <p>設計基準対象施設として使用する格納容器再循環ユニットに内蔵する冷却コイルの伝熱面積は、出力運転時の原子炉格納容器内雰囲気温度を49℃以下に維持できる処理風量（2,600m<sup>3</sup>/min）において容量 [ ] kW（設計熱交換量）を満足できることをメーカーが設計段階において確認した伝熱面積 [ ]<sup>2</sup>/個以上とする。</p> <p>C、D一格納容器再循環ユニットを重大事故等時において使用する場合の伝熱面積は、設計基準対象施設の伝熱面積を基に評価しており、 [ ]<sup>2</sup>/個以上とする。</p> <p>公称値については、要求される伝熱面積と同じ [ ]<sup>2</sup>/個とする。</p> </div> <p style="text-align: center;">[ ] 枠囲みの内容は機密情報に属しますので公開できません。</p>	

赤字：設備、運用又は体制の相違（設計方針の相違）  
 青字：記載箇所又は記載内容の相違（記載方針の相違）  
 緑字：記載表現、設備名称の相違（実質的な相違なし）

第50条 原子炉格納容器の過圧破損を防止するための設備

大飯発電所3/4号炉	泊発電所3号炉	相違理由																											
<table border="1" data-bbox="262 277 965 399"> <thead> <tr> <th colspan="2">名 称</th> <th>窒素ポンペ（原子炉補機冷却水サージタンク加圧用）</th> </tr> </thead> <tbody> <tr> <td>容 量 (注1)</td> <td>Nm<sup>3</sup></td> <td>7 以上 (7 (注2))</td> </tr> <tr> <td>最高使用圧力 (注1)</td> <td>MPa</td> <td>14.7 (注3)</td> </tr> <tr> <td>最高使用温度 (注1)</td> <td>℃</td> <td>40</td> </tr> </tbody> </table> <p>(注1) 重大事故等時における使用時の値                  (注2) 公称値                  (注3) 窒素ポンペの充てん圧力14.7MPa=14.801MPa[abs]</p> <p><b>【設 定 根 拠】</b></p> <ul style="list-style-type: none"> <li>重大事故等対処設備</li> </ul> <p>重大事故等時に原子炉冷却系統施設のうち原子炉補機冷却設備として使用する窒素ポンペ（原子炉補機冷却水サージタンク加圧用）は、以下の機能を有する。</p> <p>窒素ポンペ（原子炉補機冷却水サージタンク加圧用）は、設計基準対象施設が有する原子炉格納容器内の冷却機能が喪失した場合において炉心の著しい損傷を防止するため、原子炉格納容器内の圧力及び温度を低下させるために設置する。また、炉心の著しい損傷が発生した場合において原子炉格納容器の破損を防止するため、原子炉格納容器内の圧力及び温度を低下させるために設置する。</p> <p>これらの系統構成は、海水ポンプを用いてA原子炉補機冷却水冷却器へ海水を通水するとともに、原子炉補機冷却水の沸騰防止のため、原子炉補機冷却水サージタンクに窒素ポンペ（原子炉補機冷却水サージタンク加圧用）を接続して窒素加圧し、A、B原子炉補機冷却水ポンプによりA、D格納容器再循環ユニットへ原子炉補機冷却水を通水できる設計とする。</p> <p>窒素ポンペ（原子炉補機冷却水サージタンク加圧用）は、重大事故等対処設備として常用2、予備1の合計3個設置する。</p> <p>1. 容量 (7Nm<sup>3</sup>以上(7Nm<sup>3</sup>))</p> <p>窒素ポンペ（原子炉補機冷却水サージタンク加圧用）を重大事故等時に使用する場合は、高圧ガス保安法の適合品である一般汎用型を使用する。このため、当該ポンペの容量は、一般汎用型の窒素ポンペの標準容量 (7Nm<sup>3</sup>) とする。</p> <p>窒素ポンペ（原子炉補機冷却水サージタンク加圧用）を重大事故等時に使用する場合は、容量は、原子炉補機冷却水の沸騰を防止するために原子炉補機冷却水サージタンクを初期圧力 <input type="text" value="14.7"/> MPa[abs]か <input type="text" value="14.801"/> MPa[abs]に加圧するのに必要な容量を基に設定する。</p> <p style="border: 1px solid black; padding: 2px; text-align: center;">枠囲みの範囲は機密に係る事項ですので公開することはできません。</p>	名 称		窒素ポンペ（原子炉補機冷却水サージタンク加圧用）	容 量 (注1)	Nm <sup>3</sup>	7 以上 (7 (注2))	最高使用圧力 (注1)	MPa	14.7 (注3)	最高使用温度 (注1)	℃	40	<p style="text-align: center;">容-8(1/3)</p> <table border="1" data-bbox="1173 336 1883 528"> <thead> <tr> <th colspan="2">名 称</th> <th>原子炉補機冷却水サージタンク加圧用 可搬型窒素ガスポンペ</th> </tr> </thead> <tbody> <tr> <td>容 量</td> <td>L/個</td> <td>46.7 以上 (46.7)</td> </tr> <tr> <td>最高使用圧力</td> <td>MPa</td> <td>19.6</td> </tr> <tr> <td>最高使用温度</td> <td>℃</td> <td>40</td> </tr> <tr> <td>個 数</td> <td>-</td> <td>2以上 (4 (予備2))</td> </tr> </tbody> </table> <p><b>【設 定 根 拠】</b></p> <ul style="list-style-type: none"> <li>重大事故等対処設備</li> </ul> <p>重大事故等時に使用する原子炉補機冷却水サージタンク加圧用可搬型窒素ガスポンペは、以下の機能を有する。</p> <p>原子炉冷却系統施設のうち原子炉補機冷却設備として使用する原子炉補機冷却水サージタンク加圧用可搬型窒素ガスポンペは、設計基準事故対処設備が有する原子炉格納容器内の冷却機能が喪失した場合において炉心の著しい損傷を防止するため、原子炉格納容器内の圧力及び温度を低下させるために設置する。</p> <p>系統構成は格納容器内自然対流冷却として、原子炉補機冷却水サージタンク加圧用可搬型窒素ガスポンペは原子炉補機冷却水の沸騰防止のため、原子炉補機冷却水サージタンクに接続して窒素加圧し、C、D-原子炉補機冷却水ポンプによりC、D-格納容器再循環ユニットへ原子炉補機冷却水を通水できる設計とする。これらの系統構成については、設備別記載事項の設定根拠に関する説明書別添3「技術基準規則 第64条系統図」による。</p> <p>原子炉冷却系統施設のうち原子炉補機冷却設備として使用する原子炉補機冷却水サージタンク加圧用可搬型窒素ガスポンペは、炉心の著しい損傷が発生した場合に原子炉格納容器内の圧力及び温度を低下させるために設置する。また、炉心の著しい損傷が発生した場合に原子炉格納容器の破損を防止するため、原子炉格納容器内の圧力及び温度並びに放射性物質の濃度を低下させるために設置する。</p> <p>系統構成は格納容器内自然対流冷却として、原子炉補機冷却水サージタンク加圧用可搬型窒素ガスポンペは原子炉補機冷却水の沸騰防止のため、原子炉補機冷却水サージタンクに接続して窒素加圧し、C、D-原子炉補機冷却水ポンプによりC、D-格納容器再循環ユニット</p>	名 称		原子炉補機冷却水サージタンク加圧用 可搬型窒素ガスポンペ	容 量	L/個	46.7 以上 (46.7)	最高使用圧力	MPa	19.6	最高使用温度	℃	40	個 数	-	2以上 (4 (予備2))	
名 称		窒素ポンペ（原子炉補機冷却水サージタンク加圧用）																											
容 量 (注1)	Nm <sup>3</sup>	7 以上 (7 (注2))																											
最高使用圧力 (注1)	MPa	14.7 (注3)																											
最高使用温度 (注1)	℃	40																											
名 称		原子炉補機冷却水サージタンク加圧用 可搬型窒素ガスポンペ																											
容 量	L/個	46.7 以上 (46.7)																											
最高使用圧力	MPa	19.6																											
最高使用温度	℃	40																											
個 数	-	2以上 (4 (予備2))																											

赤字：設備、運用又は体制の相違（設計方針の相違）  
 青字：記載箇所又は記載内容の相違（記載方針の相違）  
 緑字：記載表現、設備名称の相違（実質的な相違なし）

第50条 原子炉格納容器の過圧破損を防止するための設備

大飯発電所3 / 4号炉	泊発電所3号炉	相違理由
<p style="text-align: center;">大飯発電所3 / 4号炉</p> <div style="border: 1px solid black; padding: 5px; margin: 10px 0;"> <p>加圧を要する原子炉補機冷却水サージタンク気相部の体積が <math>\square \text{ m}^3</math> であることから、窒素ポンベ（原子炉補機冷却水サージタンク加圧用）の必要容量は、以下のとおり約 <math>12.1 \text{ Nm}^3</math> とする。</p> <math display="block">\square \text{ m}^3 \times \square \text{ MPa[abs]} - \square \text{ MPa[abs]} \div 0.101 \text{ MPa[abs]} = \square \text{ Nm}^3</math> <p>また、原子炉補機冷却水サージタンクを加圧する場合の供給可能量は、窒素ポンベ（原子炉補機冷却水サージタンク加圧用）の充てん圧力が <math>14.801 \text{ MPa[abs]}</math> であることから、以下のとおり <math>\square \text{ Nm}^3</math> /個とする。</p> <math display="block">7 \text{ Nm}^3 / \text{個} \times \square \text{ MPa[abs]} - \square \text{ MPa[abs]} \div 14.801 \text{ MPa[abs]} = \square \text{ Nm}^3 / \text{個}</math> <p>上記の窒素ポンベ（原子炉補機冷却水サージタンク加圧用）の必要容量及び供給可能量から必要個数は、以下のとおり <math>\square</math> 個とする。</p> <math display="block">\square \text{ Nm}^3 / \square \text{ Nm}^3 / \text{個} = \square \text{ 個}</math> <p>以上より、窒素ポンベ（原子炉補機冷却水サージタンク加圧用）の設置数は、<math>7 \text{ Nm}^3</math> のものを2個、保守点検中でも使用可能であるため、保守点検用は考慮せずに、故障時のバックアップ用として1個、合計で3個を設置する。</p> <p>2. 最高使用圧力（14.7MPa）</p> <p>窒素ポンベ（原子炉補機冷却水サージタンク加圧用）を重大事故等時において使用する場合の最高使用圧力は、高圧ガス保安法に基づくポンベにて実績を有する充てん圧力である、<math>14.7 \text{ MPa}</math> とする。</p> <p>3. 最高使用温度（40℃）</p> <p>窒素ポンベ（原子炉補機冷却水サージタンク加圧用）を重大事故等時において使用する場合の最高使用温度は、高圧ガス保安法にて規定している一般高圧ガス保安規定に基づき、<math>40^\circ\text{C}</math> とする。</p> </div> <div style="border: 1px solid black; padding: 5px; margin-top: 10px; text-align: center;"> <p>枠囲みの範囲は機密に係る事項ですので公開することはできません。</p> </div>	<p style="text-align: center;">泊発電所3号炉</p> <p style="text-align: center;">容-8(2/3)</p> <div style="border: 1px solid black; padding: 5px; margin: 10px 0;"> <p>へ原子炉補機冷却水を通水できる設計とする。これらの系統構成については、設備別記載事項の設定根拠に関する説明書別添3「技術基準規則 第64条65条系統図」による。</p> <p>原子炉補機冷却水サージタンク加圧用可搬型窒素ガスポンベの保有数は、1セット2個、保守点検中にも使用可能であるため、保守点検による待機除外時のバックアップ用は考慮せずに故障時のバックアップ用として2個の合計4個を保管する。</p> <p>1. 容量</p> <p>重大事故等時に使用する原子炉補機冷却水サージタンク加圧用可搬型窒素ガスポンベは、高圧ガス保安法の適合品である一般汎用型の窒素ガスポンベを使用する。このため、当該ポンベの容量は一般汎用型の窒素ガスポンベの標準容量 <math>46.7 \text{ L}</math> /個以上とする。</p> <p>また、重大事故等時に原子炉補機冷却水の沸騰を防止するために原子炉補機冷却水サージタンクの気相部体積 <math>\square \text{ m}^3</math> を初期圧力 <math>\square \text{ MPa[abs]}</math> から <math>\square \text{ MPa[abs]}</math> に加圧するのに必要な窒素量は <math>\square \text{ Nm}^3</math> (E1) であり、上記圧力下での原子炉補機冷却水サージタンク加圧用可搬型窒素ガスポンベの窒素供給可能量は、<math>\square \text{ Nm}^3</math> (E2) であることから、原子炉補機冷却水サージタンク加圧用可搬型窒素ガスポンベの必要個数は、<math>\square</math> 個 (<math>\square \text{ Nm}^3 / \square \text{ Nm}^3</math>) となる。</p> <p>このため、原子炉補機冷却水サージタンク加圧用可搬型窒素ガスポンベの設定個数は、<math>\square</math> 個を上回る2個とする。</p> <p>なお、C、D-原子炉格納容器再循環ユニットを使用した自然対流冷却による原子炉格納容器内の冷却時は、原子炉補機冷却系統は健全でありリークはなく連続加圧の必要はないため、加圧回数は1回とする。</p> <p>公称値については、要求される容量と同じ <math>46.7 \text{ L}</math> /個とする。</p> <p>2. 最高使用圧力</p> <p>原子炉補機冷却水サージタンク加圧用可搬型窒素ガスポンベを重大事故等時において使用する場合は圧力は、高圧ガス保安法の適合品であるポンベにて実績を有する充てん圧力である <math>19.6 \text{ MPa}</math> とする。</p> <p>3. 最高使用温度</p> <p>原子炉補機冷却水サージタンク加圧用可搬型窒素ガスポンベを重大事故等時において使用する場合は温度は、高圧ガス保安法に基づき <math>40^\circ\text{C}</math> とする。</p> </div> <div style="border: 1px solid black; padding: 5px; margin-top: 10px; text-align: center;"> <p><math>\square</math> 枠囲みの内容は機密情報に属しますので公開できません。</p> </div>	

赤字：設備、運用又は体制の相違（設計方針の相違）  
 青字：記載箇所又は記載内容の相違（記載方針の相違）  
 緑字：記載表現、設備名称の相違（実質的な相違なし）

第50条 原子炉格納容器の過圧破損を防止するための設備

大飯発電所3/4号炉	泊発電所3号炉	相違理由
	<p style="text-align: right;">容-8(3/3)</p> <div style="border: 1px solid black; padding: 10px;"> <p>(注1) 原子炉補機冷却水サージタンクを加圧するために必要な窒素量は、気相部の体積が <input type="text"/> m<sup>3</sup> であることから以下のとおりとする。</p> <math display="block">V_1 = Q_1 \times (P_1 - P_2) / P_0 = \text{<input type="text"/>}</math> <p>                     V<sub>1</sub>: 原子炉補機冷却水サージタンクの窒素消費量 (Nm<sup>3</sup>)                      Q<sub>1</sub>: 原子炉補機冷却水サージタンクの気相部の体積 (m<sup>3</sup>) = <input type="text"/>                      P<sub>1</sub>: 原子炉補機冷却水サージタンクに加圧圧力 (MPa[abs]) = <input type="text"/>                      P<sub>2</sub>: 原子炉補機冷却水サージタンクの初期圧力 (MPa[abs]) = <input type="text"/>                      P<sub>0</sub>: 絶対圧力 (MPa[abs]) = 0.101                 </p> <p>(注2) 原子炉補機冷却水サージタンク加圧用可搬型窒素ガスポンプ内の窒素量は、以下のとおりとする。</p> <math display="block">Q = P \times V_1 / 0.101 = 19.701 \times 46.7 \times 10^{-3} / 0.101 = 9.1 \text{ Nm}^3</math> <p>                     Q: 窒素ポンプ内の窒素量 (Nm<sup>3</sup>)                      V<sub>1</sub>: ポンプの容量 (m<sup>3</sup>) = 46.7 × 10<sup>-3</sup>                      P: ポンプの充てん圧力 (MPa[abs]) = 19.6 + 0.101 = 19.701                 </p> <p>原子炉補機冷却水サージタンクを加圧する場合の窒素供給可能量は、充てん圧力が 19.701 MPa[abs] であることから以下のとおりとする。(窒素ポンプの充てん圧力 19.6MPa = 19.701MPa[abs])</p> <math display="block">V_2 = Q \times (P - P_1) / P = \text{<input type="text"/>} \text{ Nm}^3/\text{個}</math> <p>                     V<sub>2</sub>: 窒素ガスポンプ1個当たりの窒素供給可能量 (Nm<sup>3</sup>)                      Q: 窒素ガスポンプ内の窒素量 (Nm<sup>3</sup>) = 9.1                      P: ポンプの充てん圧力 (MPa[abs]) = 19.701                      P<sub>1</sub>: 原子炉補機冷却水サージタンクに加圧圧力 (MPa[abs]) = <input type="text"/> </p> </div> <p style="text-align: center; margin-top: 20px;"><input type="text"/> 枠囲みの内容は機密情報に属しますので公開できません。</p>	

赤字：設備、運用又は体制の相違（設計方針の相違）  
 青字：記載箇所又は記載内容の相違（記載方針の相違）  
 緑字：記載表現、設備名称の相違（実質的な相違なし）

第50条 原子炉格納容器の過圧破損を防止するための設備

大飯発電所3 / 4号炉	泊発電所3号炉	相違理由																		
<p>3号機</p> <table border="1" data-bbox="264 308 965 488"> <thead> <tr> <th>名称</th> <th colspan="2">可搬式代替低圧注水ポンプ</th> </tr> </thead> <tbody> <tr> <td>容量<sup>(注1)</sup></td> <td>m<sup>3</sup>/h/台</td> <td>110 以上<sup>(注2)</sup>、130 以上<sup>(注3)</sup> (150<sup>(注4)</sup>)</td> </tr> <tr> <td>揚程<sup>(注1)</sup></td> <td>m</td> <td>□ 以上<sup>(注2)</sup>、□ 以上<sup>(注3)</sup> (150<sup>(注4)</sup>)</td> </tr> <tr> <td>最高使用圧力<sup>(注1)</sup></td> <td>MPa</td> <td>□</td> </tr> <tr> <td>最高使用温度<sup>(注1)</sup></td> <td>℃</td> <td>40</td> </tr> <tr> <td>原動機出力</td> <td>kW/個</td> <td>□</td> </tr> </tbody> </table> <p>(注1) 重大事故等時における使用時の値                      (注2) 原子炉冷却系統施設のうち非常用炉心冷却設備その他原子炉注水設備で使用する場合は値                      (注3) 原子炉格納施設のうち圧力低減設備その他の安全設備（格納容器安全設備）で使用する場合は値                      (注4) 公称値</p> <p><b>【設定根拠】</b></p> <ul style="list-style-type: none"> <li>重大事故等対処設備                             <ul style="list-style-type: none"> <li>重大事故等時に原子炉冷却系統施設のうち非常用炉心冷却設備その他原子炉注水設備として炉心注水時に使用する可搬式代替低圧注水ポンプは、以下の機能を有する。</li> </ul> </li> </ul> <p>可搬式代替低圧注水ポンプは、原子炉冷却材圧力バウンダリが低圧の状態であって、設計基準事故対処設備が有する発電用原子炉の冷却機能が喪失した場合においても炉心の著しい損傷及び原子炉格納容器の破損を防止するため、発電用原子炉を冷却するために設置する。</p> <p>系統構成は、運転中の1次冷却材喪失事象時において余熱除去ポンプ、高圧注水ポンプ及び燃料取替水ピットの故障等により炉心注水機能が喪失した場合に仮設組立式水槽を水源とする可搬式代替低圧注水ポンプにホース及び配管類を取り付けることにより、格納容器スプレイ系と余熱除去系間の連絡ラインを介して原子炉へ注水することができる設計とする。</p> <p>可搬式代替低圧注水ポンプは、設計基準事故の取束に必要な水源とは別に、重大事故等の取束に必要となる十分な量の水を有する水源を確保することに加えて、発電用原子炉施設には、設計基準事故対処設備及び重大事故等対処設備に対して重大事故等の取束に必要な十分な量の水を供給するために設置する。</p> <div style="border: 1px solid black; padding: 2px; margin-top: 10px;"> <p>枠囲みの範囲は機密に係る事項ですので公開することはできません。</p> </div>	名称	可搬式代替低圧注水ポンプ		容量 <sup>(注1)</sup>	m <sup>3</sup> /h/台	110 以上 <sup>(注2)</sup> 、130 以上 <sup>(注3)</sup> (150 <sup>(注4)</sup> )	揚程 <sup>(注1)</sup>	m	□ 以上 <sup>(注2)</sup> 、□ 以上 <sup>(注3)</sup> (150 <sup>(注4)</sup> )	最高使用圧力 <sup>(注1)</sup>	MPa	□	最高使用温度 <sup>(注1)</sup>	℃	40	原動機出力	kW/個	□		<p>設備の相違                      設備構成の相違                      により比較対象                      資料なし</p>
名称	可搬式代替低圧注水ポンプ																			
容量 <sup>(注1)</sup>	m <sup>3</sup> /h/台	110 以上 <sup>(注2)</sup> 、130 以上 <sup>(注3)</sup> (150 <sup>(注4)</sup> )																		
揚程 <sup>(注1)</sup>	m	□ 以上 <sup>(注2)</sup> 、□ 以上 <sup>(注3)</sup> (150 <sup>(注4)</sup> )																		
最高使用圧力 <sup>(注1)</sup>	MPa	□																		
最高使用温度 <sup>(注1)</sup>	℃	40																		
原動機出力	kW/個	□																		



赤字：設備、運用又は体制の相違（設計方針の相違）  
 青字：記載箇所又は記載内容の相違（記載方針の相違）  
 緑字：記載表現、設備名称の相違（実質的な相違なし）

第50条 原子炉格納容器の過圧破損を防止するための設備

大飯発電所3 / 4号炉	泊発電所3号炉	相違理由
<div data-bbox="262 277 965 1286" style="border: 1px solid black; padding: 10px;"> <p>系統構成は、送水車により可搬型ホースを介して、海水を補給した仮設組立式水槽を水源とする可搬式代替低圧注水ポンプは、余熱除去系を介して、原子炉へ注水することができる設計とする。</p> <p>重大事故等時に原子炉冷却系統施設のうち非常用炉心冷却設備その他原子炉注水設備として格納容器スプレイ時に使用する可搬式代替低圧注水ポンプは、以下の機能を有する。</p> <p>可搬式代替低圧注水ポンプは、原子炉冷却材圧力バウンダリが低圧の状態であって、設計基準事故対処設備が有する発電用原子炉の冷却機能が喪失した場合においても炉心の著しい損傷及び原子炉格納容器の破損を防止するため、発電用原子炉を冷却するために設置する。</p> <p>系統構成は、炉心の著しい損傷、溶融が発生した場合において、原子炉に残存溶融デブリが存在する場合、格納容器水張り（格納容器スプレイ）により残存溶融デブリを冷却するため、仮設組立式水槽を水源とした可搬式代替低圧注水ポンプにホース及び配管類を取り付けることにより、格納容器スプレイ系を介して原子炉格納容器内上部にあるスプレイリングのスプレイノズルからの注水により原子炉格納容器内に水を張ることで残存溶融デブリの冷却を行い、原子炉格納容器の破損を防止する設計とする。</p> <p>重大事故等時に原子炉格納施設のうち圧力低減設備その他の安全設備として使用する可搬式代替低圧注水ポンプは、以下の機能を有する。</p> <p>可搬式代替低圧注水ポンプは、炉心の著しい損傷が発生した場合において原子炉格納容器の破損を防止するため、原子炉格納容器内の圧力及び温度並びに放射性物質の濃度を低下させるために設置する。</p> <p>可搬式代替低圧注水ポンプは、炉心の著しい損傷が発生した場合において原子炉格納容器の破損を防止するため、原子炉格納容器内の圧力及び温度を低下させるために設置する。</p> <p>これらの系統構成は、1次冷却材喪失事象において格納容器スプレイポンプ及び燃料取扱替用水ピットの故障等により原子炉格納容器内の冷却機能が喪失した場合に仮設組立式水槽を水源とする可搬式代替低圧注水ポンプにホース及び配管類を取り付けることにより、格納容器スプレイ系を介して原子炉格納容器内上部にあるスプレイリングのスプレイノズルより原子炉格納容器内にスプレイすることにより圧力及び温度並びに放射性物質の濃度を低下させる設計とする。</p> </div> <div data-bbox="371 1299 824 1327" style="border: 1px solid black; padding: 2px; margin-top: 10px;"> <p>枠囲みの範囲は機密に係る事項ですので公開することはできません</p> </div>		

赤字：設備、運用又は体制の相違（設計方針の相違）  
 青字：記載箇所又は記載内容の相違（記載方針の相違）  
 緑字：記載表現、設備名称の相違（実質的な相違なし）

第50条 原子炉格納容器の過圧破損を防止するための設備

大飯発電所3/4号炉	泊発電所3号炉	相違理由
<p>可搬式代替低圧注水ポンプは、設計基準事故の収束に必要な水源とは別に、重大事故等の収束に必要な十分な量の水を有する水源を確保することに加えて、発電用原子炉施設には、設計基準事故対処設備及び重大事故等対処設備に対して重大事故等の収束に必要な十分な量の水を供給するために設置する。</p> <p>系統構成は、送水車により可搬型ホースを介して、海水を補給した仮設組立式水槽を水源とする可搬式代替低圧注水ポンプは、格納容器スプレイ系を介して、原子炉格納容器上部にあるスプレイリングのスプレイノズルより原子炉格納容器内にスプレイできる設計とする。</p> <p>可搬式代替低圧注水ポンプの保有数は、3号機、4号機それぞれで2セット2台、故障時及び保守点検による待機除外時のバックアップ用として1台の合計5台（3号機及び4号機共用の予備1台を含む）を分散して保管する。</p> <p>1. 容量</p> <p>1.1 原子炉容器に注水する場合の容量（110m<sup>3</sup>/h以上）</p> <p>原子炉冷却系統施設のうち非常用炉心冷却設備その他原子炉注水設備として炉心注水時に使用する可搬式代替低圧注水ポンプの容量は、可搬式代替低圧注水ポンプが設計基準事故対処設備の機能喪失時に使用する恒設代替低圧注水ポンプの代替設備であることから、恒設代替低圧注水ポンプの有効性評価解析において有効性が確認されている原子炉への注入流量である110m<sup>3</sup>/h/台以上とする。</p> <p>1.2 原子炉格納容器内にスプレイする場合の容量（130m<sup>3</sup>/h以上）</p> <p>原子炉格納施設のうち圧力低減設備その他の安全設備又は、原子炉冷却系統施設のうち非常用炉心冷却設備その他原子炉注水設備として格納容器スプレイ時に使用する可搬式代替低圧注水ポンプの容量は、可搬式代替低圧注水ポンプが設計基準事故対処設備の機能喪失時に使用する恒設代替低圧注水ポンプの代替設備であることから、恒設代替低圧注水ポンプの有効性評価解析において有効性が確認されている格納容器への注水流量である130m<sup>3</sup>/h/台以上とする。</p> <p>公称値については、可搬式代替低圧注水ポンプに要求される最大容量130m<sup>3</sup>/h/台を満足するものとして定格容量150m<sup>3</sup>/h/台とする。</p> <p>2. 揚程</p> <p>2.1原子炉に注水する場合の揚程 <span style="border: 1px solid black; padding: 0 5px;">  </span> m以上</p> <div style="border: 1px solid black; padding: 5px; margin-top: 10px; text-align: center;"> <p>枠囲みの範囲は機密に係る事項ですので公開することはできません。</p> </div>		

赤字：設備、運用又は体制の相違（設計方針の相違）  
 青字：記載箇所又は記載内容の相違（記載方針の相違）  
 緑字：記載表現、設備名称の相違（実質的な相違なし）

第50条 原子炉格納容器の過圧破損を防止するための設備

大飯発電所3 / 4号炉	泊発電所3号炉	相違理由																				
<div data-bbox="264 276 965 1286" style="border: 1px solid black; padding: 10px;"> <p>原子炉冷却系統施設のうち非常用炉心冷却設備その他原子炉注水設備として炉心注水時に使用する可搬式代替低圧注水ポンプの揚程は、海水を原子炉に注水する場合の水源と移送先の圧力差、静水頭、機器圧損、配管・ホース及び弁類圧損を基に設定する。</p> <table style="margin-left: auto; margin-right: auto;"> <tr><td>水源と移送先の圧力差</td><td style="text-align: right;">□ m</td></tr> <tr><td>静水頭</td><td style="text-align: right;">□ m</td></tr> <tr><td>機器圧損</td><td style="text-align: right;">□ m</td></tr> <tr><td>配管・ホース及び弁類圧損</td><td style="text-align: right;">□ m</td></tr> <tr><td>合計</td><td style="text-align: right;">□ m</td></tr> </table> <p>以上より、原子炉冷却系統施設のうち非常用炉心冷却設備その他原子炉注水設備として炉心注水時に使用する可搬式代替低圧注水ポンプの揚程は、□ m以上とする。</p> <p>2.3 原子炉格納容器内にスプレイする場合の揚程（□ m以上）</p> <p>原子炉格納施設のうち圧力低減設備その他の安全設備又は、原子炉冷却系統施設のうち非常用炉心冷却設備その他原子炉注水設備として格納容器スプレイ時に使用する可搬式代替低圧注水ポンプの揚程は、海水を原子炉格納容器内にスプレイする場合の水源と移送先の圧力差、静水頭、機器圧損、配管・ホース及び弁類圧損を基に設定する。</p> <table style="margin-left: auto; margin-right: auto;"> <tr><td>水源と移送先の圧力差</td><td style="text-align: right;">□ m</td></tr> <tr><td>静水頭</td><td style="text-align: right;">□ m</td></tr> <tr><td>機器圧損</td><td style="text-align: right;">□ m</td></tr> <tr><td>配管・ホース及び弁類圧損</td><td style="text-align: right;">□ m</td></tr> <tr><td>合計</td><td style="text-align: right;">□ m</td></tr> </table> <p>原子炉格納施設のうち圧力低減設備その他の安全設備又は、原子炉冷却系統施設のうち非常用炉心冷却設備その他原子炉注水設備として格納容器スプレイ時に使用する可搬式代替低圧注水ポンプの揚程は、□ m以上とする。</p> <p>公称値については、可搬式代替低圧注水ポンプに要求される最大揚程□ mを満足するものとして余裕を考慮し、定格揚程が150mのポンプとする。</p> <p>3. 最高使用圧力（□ MPa）</p> <p>可搬式代替低圧注水ポンプを重大事故時において使用する場合圧力は、ポンプ締切圧力</p> <div style="border: 1px solid black; padding: 2px; margin-top: 10px; text-align: center;">                 枠囲みの範囲は機密に係る事項ですので公開することはできません。             </div> </div>	水源と移送先の圧力差	□ m	静水頭	□ m	機器圧損	□ m	配管・ホース及び弁類圧損	□ m	合計	□ m	水源と移送先の圧力差	□ m	静水頭	□ m	機器圧損	□ m	配管・ホース及び弁類圧損	□ m	合計	□ m		
水源と移送先の圧力差	□ m																					
静水頭	□ m																					
機器圧損	□ m																					
配管・ホース及び弁類圧損	□ m																					
合計	□ m																					
水源と移送先の圧力差	□ m																					
静水頭	□ m																					
機器圧損	□ m																					
配管・ホース及び弁類圧損	□ m																					
合計	□ m																					

赤字：設備、運用又は体制の相違（設計方針の相違）  
 青字：記載箇所又は記載内容の相違（記載方針の相違）  
 緑字：記載表現、設備名称の相違（実質的な相違なし）

第50条 原子炉格納容器の過圧破損を防止するための設備

大飯発電所3 / 4号炉	泊発電所3号炉	相違理由
<p>が <input type="text"/> MPaであり、当該ポンプを使用する系統においては、弁等により他の系統と隔離しており、当該ポンプの他に加圧要因がないことから <input type="text"/> MPaとする。</p> <p>4. 最高使用温度（40℃）                  可搬式代替低圧注水ポンプを重大事故等時において使用する場合は、水源である海水の温度が40℃を下回るため40℃とする。</p> <p>5. 原動機出力（<input type="text"/> kW個）                  可搬式代替低圧注水ポンプを重大事故等時において使用する場合は、流量150m<sup>3</sup>/h時の軸動力を基に設定する。                  可搬式代替低圧注水ポンプの流量が150m<sup>3</sup>/h、揚程が150m、そのときの同ポンプの必要軸動力は、以下のとおり <input type="text"/> kWとなる。</p> <div data-bbox="280 639 689 1023" style="border: 2px solid black; width: 183px; height: 240px; margin: 10px auto;"></div> <p>（参考文献：「ターボポンプ用語」（JIS B 0131-2002））                  以上より、可搬式代替低圧注水ポンプの原動機出力は <input type="text"/> kW個とする。</p> <div data-bbox="376 1110 848 1142" style="border: 1px solid black; padding: 2px; margin: 10px auto; width: fit-content;">                     枠囲みの範囲は機密に係る事項ですので公開することはできません。                 </div>		

赤字：設備、運用又は体制の相違（設計方針の相違）  
 青字：記載箇所又は記載内容の相違（記載方針の相違）  
 緑字：記載表現、設備名称の相違（実質的な相違なし）

第50条 原子炉格納容器の過圧破損を防止するための設備

大飯発電所3/4号炉	泊発電所3号炉	相違理由									
<table border="1" data-bbox="262 308 965 427"> <thead> <tr> <th colspan="2">名 称</th> <th>電源車（可搬式代替低圧注水ポンプ用）</th> </tr> </thead> <tbody> <tr> <td>個 数</td> <td>—</td> <td>2（予備1）<sup>(注1)</sup></td> </tr> <tr> <td>容 量</td> <td>kVA/個</td> <td>610</td> </tr> </tbody> </table> <p data-bbox="622 403 949 424">(注1) 3号及び4号炉共用の予備1台。</p> <p data-bbox="266 434 418 454">【設 定 根 拠】</p> <p data-bbox="284 461 958 603">設計基準事故対処設備の電源が喪失したことにより、重大事故等が発生した場合において、炉心の著しい損傷、原子炉格納容器の破損等を防止するために必要な電力を確保できる設備を設ける。また、必要な容量を賄うことができる設備を1基あたり2セット以上に加え、故障時のバックアップ及び保守点検による待機除外時のバックアップを発電所全体で確保する設計とする。</p> <p data-bbox="268 641 344 662">1. 容量</p> <p data-bbox="284 670 958 809">電源車（可搬式代替低圧注水ポンプ用）は設計基準事故対処設備の機能が喪失した場合において、炉心の著しい損傷及び格納容器破損を防止するために必要な可搬式代替低圧注水ポンプの駆動に十分な容量を有する設計とする。可搬式代替低圧注水ポンプの駆動に必要な負荷容量は132kWであり、十分な余裕をみて発電機の出力は488kWを選定し、発電機の容量は以下のとおり610kVAとする。</p> $Q \geq P / p f = 488 / 0.8 = 610$ <p data-bbox="344 906 651 991">                 Q : 発電機の容量 (kVA)                  P : 発電機の出力 (kW) = 488                  p f : 力率 = 0.8             </p>	名 称		電源車（可搬式代替低圧注水ポンプ用）	個 数	—	2（予備1） <sup>(注1)</sup>	容 量	kVA/個	610		<p data-bbox="1973 170 2123 296">設備の相違                  設備構成の相違                  により比較対象                  資料なし</p>
名 称		電源車（可搬式代替低圧注水ポンプ用）									
個 数	—	2（予備1） <sup>(注1)</sup>									
容 量	kVA/個	610									

赤字：設備、運用又は体制の相違（設計方針の相違）  
 青字：記載箇所又は記載内容の相違（記載方針の相違）  
 緑字：記載表現、設備名称の相違（実質的な相違なし）

第50条 原子炉格納容器の過圧破損を防止するための設備

大飯発電所3 / 4号炉	泊発電所3号炉	相違理由												
<table border="1" data-bbox="262 308 965 424"> <thead> <tr> <th colspan="2">名 称</th> <th>仮設組立式水槽</th> </tr> </thead> <tbody> <tr> <td>容 量 (E1)</td> <td>m<sup>3</sup>/基</td> <td>(E2)</td> </tr> <tr> <td>最高使用圧力 (E1)</td> <td>—</td> <td></td> </tr> <tr> <td>最高使用温度 (E1)</td> <td>℃</td> <td></td> </tr> </tbody> </table> <p>(注1) 重大事故等時における使用時の値                  (注2) 公称値</p> <p>原子炉冷却系統施設のうち非常用炉心冷却設備その他原子炉注水設備及び原子炉格納施設のうち圧力低減設備その他の安全設備（格納容器安全設備）と兼用</p> <p><b>【設 定 根 拠】</b></p> <ul style="list-style-type: none"> <li>重大事故等対処設備                     <ul style="list-style-type: none"> <li>重大事故等時に原子炉冷却系統施設のうち非常用炉心冷却設備その他原子炉注水設備として使用する仮設組立式水槽は、以下の機能を有する。</li> </ul> </li> </ul> <p>仮設組立式水槽は、原子炉冷却材圧力バウンダリが低圧の状態であって、設計基準事故対処設備が有する発電用原子炉の冷却機能が喪失した場合においても炉心の著しい損傷及び原子炉格納容器の破損を防止するため、発電用原子炉を冷却するために設置する。</p> <p>系統構成は、運転中の1次冷却材喪失事象時において余熱除去ポンプ、高圧注入ポンプ及び燃料取替用水ピットの故障等により炉心注水機能が喪失した場合に仮設組立式水槽を水源とする可搬式代替低圧注水ポンプにホース及び配管類を取り付けることにより、格納容器スプレイ系と余熱除去系間の連絡ラインを介して原子炉へ注水できる設計とする。</p> <p>仮設組立式水槽は、原子炉冷却材圧力バウンダリが低圧の状態であって、設計基準事故対処設備が有する発電用原子炉の冷却機能が喪失した場合においても炉心の著しい損傷及び原子炉格納容器の破損を防止するため、発電用原子炉を冷却するために設置する。</p> <p>系統構成は、炉心の著しい損傷、溶融が発生した場合において、原子炉に残存溶融デブリが存在する場合、格納容器水張り（格納容器スプレイ）により残存溶融デブリを冷却するため、仮設組立式水槽を水源とした可搬式代替低圧注水ポンプにホース及び配管類を取り付けることにより、格納容器スプレイ系を介して原子炉格納容器内上部にあるスプレイングの</p> <div data-bbox="367 1289 871 1334" style="border: 1px solid black; padding: 2px; margin-top: 20px;"> <p>枠囲みの範囲は機密に係る事項ですので公開することはできません。</p> </div>	名 称		仮設組立式水槽	容 量 (E1)	m <sup>3</sup> /基	(E2)	最高使用圧力 (E1)	—		最高使用温度 (E1)	℃			<p>設備の相違                  設備構成の相違                  により比較対象                  資料なし</p>
名 称		仮設組立式水槽												
容 量 (E1)	m <sup>3</sup> /基	(E2)												
最高使用圧力 (E1)	—													
最高使用温度 (E1)	℃													

赤字：設備、運用又は体制の相違（設計方針の相違）  
 青字：記載箇所又は記載内容の相違（記載方針の相違）  
 緑字：記載表現、設備名称の相違（実質的な相違なし）

第50条 原子炉格納容器の過圧破損を防止するための設備

大飯発電所3 / 4号炉	泊発電所3号炉	相違理由
<div data-bbox="262 277 965 1230" style="border: 1px solid black; padding: 10px;"> <p>スプレインゾルより原子炉格納容器内にスプレイすることで原子炉格納容器の破損を防止する設計とする。</p> <p>仮設組立式水槽は、設計基準事故の収束に必要な水源とは別に、重大事故等の収束に必要な十分な量の水を有する水源を確保することに加えて、発電用原子炉施設には、設計基準事故対処設備及び重大事故等対処設備に対して重大事故等の収束に必要な十分な量の水を供給するために設置する。</p> <p>系統構成は、炉心注水及び格納容器スプレイの水源となる燃料取替用水ビットが枯渇又は破損した場合の代替手段である可搬式代替低圧注水ポンプによる代替炉心注水及び代替格納容器スプレイの水源として、代替水源である仮設組立式水槽、送水車、可搬式代替低圧注水ポンプ、電源車（可搬式代替低圧注水ポンプ用）、燃料油貯蔵タンク、重油タンク、タンクローリー及び軽油ドラム缶を使用する。送水車により可搬型ホースを介して、海水を補給した仮設組立式水槽を水源とする可搬式代替低圧注水ポンプは、格納容器スプレイ系統と余熱除去系統間の連絡ラインを介して、原子炉へ注水できる設計とする。</p> <p>重大事故等時に原子炉格納施設のうち圧力低減設備その他の安全設備として使用する可搬式代替低圧注水ポンプは、以下の機能を有する。</p> <p>仮設組立式水槽は、設計基準事故対処設備が有する原子炉格納容器内の冷却機能が喪失した場合において炉心の著しい損傷を防止するため、原子炉格納容器内の圧力及び温度を低下させるために設置する。</p> <p>また、炉心の著しい損傷が発生した場合において原子炉格納容器の破損を防止するため、原子炉格納容器内の圧力及び温度並びに放射性物質の濃度を低下させるために設置する。</p> <p>系統構成は、1次冷却材喪失事象において格納容器スプレイポンプ及び燃料取替用水ビットの故障等により原子炉格納容器内の冷却機能が喪失した場合に仮設組立式水槽を水源とする可搬式代替低圧注水ポンプにホース及び配管類を取り付けることにより、格納容器スプレイ系を介して原子炉格納容器内上部にあるスプレイリングのスプレインゾルより原子炉格納容器内にスプレイできる設計とする。</p> <p>仮設組立式水槽は、設計基準事故の収束に必要な水源とは別に、重大事故等の収束に必要な十分な量の水を有する水源を確保することに加えて、発電用原子炉施設には、設計基</p> </div>		

赤字：設備、運用又は体制の相違（設計方針の相違）  
 青字：記載箇所又は記載内容の相違（記載方針の相違）  
 緑字：記載表現、設備名称の相違（実質的な相違なし）

第50条 原子炉格納容器の過圧破損を防止するための設備

大飯発電所3/4号炉	泊発電所3号炉	相違理由
<div data-bbox="264 276 965 1142" style="border: 1px solid black; padding: 5px;"> <p>準事故対処設備及び重大事故等対処設備に対して重大事故等の収束に必要な十分な量の水を供給するために設置する。</p> <p>系統構成は、炉心注水及び格納容器スプレイの水源となる燃料取替用水ピットが枯渇又は破損した場合の代替手段である可搬式代替低圧注水ポンプによる代替炉心注水及び代替格納容器スプレイの水源として、代替水源である仮設組立式水槽、送水車、可搬式代替低圧注水ポンプ、電源車（可搬式代替低圧注水ポンプ用）、燃料油貯蔵タンク、重油タンク、タンクローリー及び軽油ドラム缶を使用する。送水車により可搬型ホースを介して、海水を補給した仮設組立式水槽を水源とする可搬式代替低圧注水ポンプは、格納容器スプレイ系統と余熱除去系統間の連絡ラインを介して、格納容器へ注水できる設計とする。</p> <p>仮設組立式水槽の保有数は、3号機、4号機それぞれで2セット2基、故障時及び保守点検による待機除外時のバックアップ用として1基の合計5基（3号機及び4号機共用の予備1基を含む）を分散して保管する。</p> <p>1. 容量（<math>\square</math> m<sup>3</sup>/基）                      仮設組立式水槽は、以下の機能を発揮するために、必要な容量を基に設定する。                      可搬式代替低圧注水ポンプの水源としての貯水槽であり、可搬式代替低圧注水ポンプにおける最大注水量の <math>\square</math> m<sup>3</sup>/hの容量に対し、貯水槽に海水を連続的に補給する送水車からの補給量は <math>\square</math> m<sup>3</sup>/hと注水量を上回っている。                      可搬式代替低圧注水ポンプの運転に支障がないよう十分な余裕を持った <math>\square</math> m<sup>3</sup>容量とする。</p> <p>2. 最高使用圧力 <math>\square</math>                      仮設組立式水槽の最高使用圧力は、大気開放式の貯水槽であることから、大気圧とする。</p> <p>3. 最高使用温度（<math>\square</math> °C）                      仮設組立式水槽の最高使用温度は、送水車により海水を受け入れる大気開放式の貯水槽であり、送水車の最高使用温度と同じ <math>\square</math> °Cとする。</p> </div> <div data-bbox="360 1177 864 1222" style="border: 1px solid black; padding: 2px; margin-top: 10px;"> <p>特開みの範囲は機密に係る事項ですので公開することはできません。</p> </div>		



赤字：設備、運用又は体制の相違（設計方針の相違）  
 青字：記載箇所又は記載内容の相違（記載方針の相違）  
 緑字：記載表現、設備名称の相違（実質的な相違なし）

第50条 原子炉格納容器の過圧破損を防止するための設備

大飯発電所3/4号炉	泊発電所3号炉	相違理由																		
<p>3号機</p> <table border="1" data-bbox="255 308 954 547"> <thead> <tr> <th colspan="2">名称</th> <th>送水車</th> </tr> </thead> <tbody> <tr> <td>容量</td> <td>m<sup>3</sup>/h/台</td> <td>(注1)、(注2)、(注3)、(注4)、(注5)</td> </tr> <tr> <td>吐出圧力</td> <td>MPa</td> <td>(注1)、(注2)、(注3.5)、(注4)、(注5)</td> </tr> <tr> <td>最高使用圧力</td> <td>MPa</td> <td></td> </tr> <tr> <td>最高使用温度</td> <td>℃</td> <td></td> </tr> <tr> <td>原動機の出力</td> <td>kW/台</td> <td></td> </tr> </tbody> </table> <p><b>【設定根拠】</b>                      (注1) 核燃料物質の取扱施設及び貯蔵施設のうち使用済燃料貯蔵槽冷却浄化設備で使用する場合の値（使用済燃料ピットへの注水）                      (注2) 核燃料物質の取扱施設及び貯蔵施設のうち使用済燃料貯蔵槽冷却浄化設備で使用する場合の値（使用済燃料ピットへのスプレイ）                      (注3) 原子炉冷却系統施設のうち非常用炉心冷却設備その他原子炉注水設備で使用する場合の値                      (注4) 原子炉冷却系統施設のうち蒸気タービンの附属設備で使用する場合の値                      (注5) 原子炉格納施設のうち圧力低減設備その他の安全設備（格納容器安全設備）で使用する場合の値                      (注6) 公称値</p> <p>核燃料物質の取扱施設及び貯蔵施設のうち使用済燃料貯蔵槽冷却浄化設備、原子炉冷却系統施設のうち非常用炉心冷却設備その他原子炉注水設備、原子炉冷却系統施設のうち蒸気タービンの附属設備及び原子炉格納施設のうち圧力低減設備その他の安全設備（格納容器安全設備）と兼用</p> <p><b>【設定根拠】</b>                      ・重大事故等対処設備                      重大事故等時に核燃料物質の取扱施設及び貯蔵施設のうち使用済燃料貯蔵槽冷却浄化設備として使用する送水車は、以下の機能を有する。                      送水車は、使用済燃料貯蔵槽の冷却機能又は注水機能が喪失し、又は使用済燃料貯蔵槽からの水の漏えいその他の要因により当該使用済燃料貯蔵槽の水位が低下した場合において貯蔵槽内燃料体等を冷却し、放射線を遮蔽し、及び臨界を防止するために設置する。</p> <div style="border: 1px solid black; padding: 5px; margin-top: 10px;"> <p>枠囲みの範囲は機密に係る事項ですので公開することはできません。</p> </div>	名称		送水車	容量	m <sup>3</sup> /h/台	(注1)、(注2)、(注3)、(注4)、(注5)	吐出圧力	MPa	(注1)、(注2)、(注3.5)、(注4)、(注5)	最高使用圧力	MPa		最高使用温度	℃		原動機の出力	kW/台			<p>設備の相違                      設備構成の相違                      により比較対象                      資料なし</p>
名称		送水車																		
容量	m <sup>3</sup> /h/台	(注1)、(注2)、(注3)、(注4)、(注5)																		
吐出圧力	MPa	(注1)、(注2)、(注3.5)、(注4)、(注5)																		
最高使用圧力	MPa																			
最高使用温度	℃																			
原動機の出力	kW/台																			

赤字：設備、運用又は体制の相違（設計方針の相違）  
 青字：記載箇所又は記載内容の相違（記載方針の相違）  
 緑字：記載表現、設備名称の相違（実質的な相違なし）

第50条 原子炉格納容器の過圧破損を防止するための設備

大飯発電所3/4号炉	泊発電所3号炉	相違理由
<div data-bbox="255 277 954 1283" style="border: 1px solid black; padding: 5px;"> <p>系統構成は、可搬型代替注水設備（使用済燃料ピットへの注水）としては、海水を送水車により使用済燃料ピットへ注水できる設計とする。</p> <p>送水車は、使用済燃料ピットの冷却機能の喪失及び注水機能の喪失による水位低下を防止するため、使用済燃料ピットに貯蔵している燃料体等からの崩壊熱による使用済燃料ピット水の蒸散量を上回る補給量を有する設計とする。</p> <p>送水車は、使用済燃料貯蔵槽からの大量の水の漏えいその他の要因により当該使用済燃料貯蔵槽の水位が異常に低下した場合において貯蔵槽内燃料体等の著しい損傷の進行を緩和し、及び臨界を防止するために設置する。</p> <p>系統構成は、可搬型スプレイ設備として、海を水源とした送水車により可搬型ホース及びスプレイヘッドを介して使用済燃料ピットへスプレイを行う設計とする。</p> <p>可搬型スプレイ設備は、使用済燃料ピット全面にスプレイすることで燃料損傷の進行を緩和し、できる限り環境への放射性物質の放出を低減することができる設計とする。</p> <p>送水車は、炉心の著しい損傷、原子炉格納容器及びアニュラス部の破損又は貯蔵槽内燃料体等の著しい損傷に至った場合において工場等外への放射性物質の拡散を抑制するために設置する。</p> <p>系統構成は、大気への拡散抑制として、海を水源とした送水車により可搬型ホース及びスプレイヘッドを介して原子炉周辺建屋へ放水を行う設計とする。</p> <p>送水車は、設計基準事故の収束に必要な水源とは別に、重大事故等の収束に必要な十分な量の水を有する水源を確保することに加えて、発電用原子炉施設には、設計基準事故対処設備及び重大事故等対処設備に対して重大事故等の収束に必要な十分な量の水を供給するために設置する。</p> <p>系統構成は、重大事故等により、使用済燃料ピットへの水の注水手段の水源となる燃料取替用水ピットが枯渇又は破損した場合の重大事故等対処設備（海から使用済燃料ピットへの注水）として、送水車、軽油ドラム缶を使用する。海を水源とした送水車は、可搬型ホースを介して使用済燃料ピットへ水を注水する設計とする。</p> <p>重大事故等時に原子炉冷却系統施設のうち非常用炉心冷却設備その他の原子炉注水設備と</p> </div>		

赤字：設備、運用又は体制の相違（設計方針の相違）  
 青字：記載箇所又は記載内容の相違（記載方針の相違）  
 緑字：記載表現、設備名称の相違（実質的な相違なし）

第50条 原子炉格納容器の過圧破損を防止するための設備

大飯発電所3/4号炉	泊発電所3号炉	相違理由
<p>して使用する送水率は、以下の機能を有する。</p> <p>送水車は、原子炉冷却材圧力バウンダリが低圧の状態であって、設計基準事故対処設備が有する発電用原子炉の冷却機能が喪失した場合においても炉心の著しい損傷及び原子炉格納容器の破損を防止するため、発電用原子炉を冷却するために設置する。</p> <p>系統構成は、運転中の1次冷却材喪失事象時において余熱除去ポンプ、高圧注入ポンプ及び燃料取扱用水ピットの故障等により炉心注水機能が喪失した場合に、海水を水源とした送水車により可搬型ホースを介して仮設組立式水槽へ海水を補給し、仮設組立式水槽に可搬式代替低圧注水ポンプ、ホース及び配管類を取り付けることにより、格納容器スプレイ系と余熱除去系間の連絡ラインを介して原子炉へ海水を注水できる設計とする。</p> <p>送水車は、原子炉冷却材圧力バウンダリが低圧の状態であって、設計基準事故対処設備が有する発電用原子炉の冷却機能が喪失した場合においても炉心の著しい損傷及び原子炉格納容器の破損を防止するため、発電用原子炉を冷却するために設置する。</p> <p>系統構成は、炉心の著しい損傷、溶融が発生した場合において、原子炉に残存溶融デブリが存在する場合、格納容器水張り（格納容器スプレイ）により残存溶融デブリを冷却するため、海水を水源とした送水車により可搬型ホースを介して仮設組立式水槽へ海水を補給し、仮設組立式水槽に可搬式代替低圧注水ポンプ、ホース及び配管類を取り付けることにより、格納容器スプレイ系を介して原子炉格納容器内上部にあるスプレイリングのスプレイノズルより原子炉格納容器内にスプレイすることで原子炉格納容器の破損を防止する設計とする。</p> <p>送水車は、設計基準事故の収束に必要な水源とは別に、重大事故等の収束に必要な十分な量の水を有する水源を確保することに加えて、発電用原子炉施設には、設計基準事故対処設備及び重大事故等対処設備に対して重大事故等の収束に必要な十分な量の水を供給するために設置する。</p> <p>重大事故等時に原子炉冷却系統施設のうち蒸気タービンの附属設備として使用する送水車は、以下の機能を有する。</p> <p>送水車は、設計基準事故の収束に必要な水源とは別に、重大事故等の収束に必要な十分な量の水を有する水源を確保することに加えて、発電用原子炉施設には、設計基準事故対処設備及び重大事故等対処設備に対して重大事故等の収束に必要な十分な量の水を供給するために設置する。</p>		

赤字：設備、運用又は体制の相違（設計方針の相違）  
 青字：記載箇所又は記載内容の相違（記載方針の相違）  
 緑字：記載表現、設備名称の相違（実質的な相違なし）

第50条 原子炉格納容器の過圧破損を防止するための設備

大飯発電所3 / 4号炉	泊発電所3号炉	相違理由
<p>系統構成は、重大事故等により、蒸気発生器二次側への注水手段の水源となる復水ビットが枯渇した場合の重大事故等対処設備として、送水車及び軽油ドラム缶を使用する。海を水源とした送水車は、可搬型ホースを介して復水ビットへ水を補給できる設計とする。</p> <p>送水車は、設計基準事故の収束に必要な水源とは別に、重大事故等の収束に必要な十分な量の水を有する水源を確保することに加えて、発電用原子炉施設には、設計基準事故対処設備及び重大事故等対処設備に対して重大事故等の収束に必要な十分な量の水を供給するために設置する。</p> <p>重大事故等時に原子炉格納施設のうち圧力低減設備その他の安全設備として使用する送水車は、以下の機能を有する。</p> <p>送水車は、設計基準事故対処設備が有する原子炉格納容器内の冷却機能が喪失した場合において炉心の著しい損傷を防止するため、原子炉格納容器内の圧力及び温度を低下させるために設置する。</p> <p>また、炉心の著しい損傷が発生した場合において原子炉格納容器の破損を防止するため、原子炉格納容器内の圧力及び温度並びに放射性物質の濃度を低下させるために設置する。</p> <p>系統構成は、1次冷却材喪失事象において格納容器スプレイポンプ及び燃料取替用水ビットの故障等により原子炉格納容器内の冷却機能が喪失した場合に、海水を水源とした送水車により可搬型ホースを介して仮設組立式水槽へ海水を補給し、仮設組立式水槽に可搬式代替低圧注水ポンプ、ホース及び配管類を取り付けることにより、格納容器スプレイ系を介して原子炉格納容器内上部にあるスプレイリングのスプレイノズルより原子炉格納容器内にスプレイできる設計とする。</p> <p>送水車は、設計基準事故の収束に必要な水源とは別に、重大事故等の収束に必要な十分な量の水を有する水源を確保することに加えて、発電用原子炉施設には、設計基準事故対処設備及び重大事故等対処設備に対して重大事故等の収束に必要な十分な量の水を供給するために設置する。</p> <p>系統構成は、炉心注水及び格納容器スプレイの水源となる燃料取替用水ビットが枯渇又は破損した場合の代替手段である可搬式代替低圧注水ポンプによる代替炉心注水及び代替格納容器スプレイの水源として、代替水源である仮設組立式水槽、送水車、可搬式代替低圧注水ポンプ、電源車（可搬式代替低圧注水ポンプ用）、燃料油貯蔵タンク、重油タンク、タンクロー</p>		

赤字：設備、運用又は体制の相違（設計方針の相違）  
 青字：記載箇所又は記載内容の相違（記載方針の相違）  
 緑字：記載表現、設備名称の相違（実質的な相違なし）

第50条 原子炉格納容器の過圧破損を防止するための設備

大飯発電所3/4号炉	泊発電所3号炉	相違理由
<p>ーリー及び軽油ドラム缶を使用する。送水車により可搬型ホースを介して、海水を補給した仮設組立式水槽を水源とする可搬式代替低圧注水ポンプは、格納容器スプレィ系統と余熱除去系統間の連絡ラインを介して、格納容器へ注水できる設計とする。</p> <p>送水車の保有数量は、3号炉、4号炉それぞれ2セット2台、故障時及び保守点検による待機除外時のバックアップ用として1台の合計5台（3号炉及び4号炉共用の予備1台含む）を分散して保管する。</p> <p>1. 容量</p> <p>送水車は、以下の機能を十分に発揮するために、必要な容量を基に設定する。</p> <ul style="list-style-type: none"> <li>・使用済燃料ビットへの注水のための必要容量を満足する設計とする。</li> <li>・使用済燃料ビットへのスプレィのための必要容量を満足する設計とする。</li> <li>・可搬式代替低圧注水ポンプによる炉心への注水のための必要容量を満足する設計とする。</li> <li>・タービン動補助給水ポンプによる蒸気発生器への給水に必要な容量を満足する設計とする。</li> <li>・可搬式代替低圧注水ポンプによる原子炉格納容器内への注水のための必要容量を満足する設計とする。</li> </ul> <p>(1) 使用済燃料ビットへ注水する場合の容量（<math>\square \text{ m}^3/\text{h}</math>以上）</p> <p>使用済燃料ビットへの注水容量については、重大事故等対策有効性評価の中で、想定事故1（使用済燃料ビット冷却系及び補給水系の故障）のシナリオにおいて最大必要容量は<math>\square \text{ m}^3/\text{h}</math>と評価しており、解析の結果、使用済燃料ビット内の燃料集合体の崩壊熱を除去できることが確認できていることから、これを上回る容量（<math>\square \text{ m}^3/\text{h}</math>以上）とする。</p> <p>送水車は、使用済燃料ビットへの注水、仮設組立式水槽への補給及び復水ビットへの補給に同時使用することから、これを上回る容量（<math>\square \text{ m}^3/\text{h}/\text{台}</math>）とする。</p> <p>(2) 使用済燃料ビットへスプレィする場合の容量（<math>\square \text{ m}^3/\text{h}</math>以上）</p> <p>使用済燃料ビットへのスプレィ容量については、使用済燃料ビットスプレィヘッドにて、使用済燃料ビット全体に放水することができる流量である<math>\square \text{ m}^3/\text{h}</math>以上とする。</p> <p>送水車は、これを上回る容量（<math>\square \text{ m}^3/\text{h}/\text{台}</math>）とする。</p> <p><span style="border: 1px solid black; padding: 2px;">枠囲みの範囲は機密に係る事項ですので公開することはできません。</span></p>		

赤字：設備、運用又は体制の相違（設計方針の相違）  
 青字：記載箇所又は記載内容の相違（記載方針の相違）  
 緑字：記載表現、設備名称の相違（実質的な相違なし）

第50条 原子炉格納容器の過圧破損を防止するための設備

大飯発電所3 / 4号炉	泊発電所3号炉	相違理由									
<div data-bbox="253 276 954 1284" style="border: 1px solid black; padding: 10px;"> <p>(3) 仮設組立式水槽へ補給する場合の容量 ( <math>\square</math> m<sup>3</sup>/h以上)</p> <ul style="list-style-type: none"> <li>原子炉へ注水する場合の容量 ( <math>\square</math> m<sup>3</sup>/h以上)                      原子炉への注水容量の最大値については、重大事故等対策有効性評価の中で、中小LOCA(2インチ破断)+ECCS注入失敗の注水量が <math>\square</math> m<sup>3</sup>/hである。                      送水車は、これを上回る容量 ( <math>\square</math> m<sup>3</sup>/h/台) とする。</li> <li>原子炉格納容器内へスプレイする場合の容量 ( <math>\square</math> m<sup>3</sup>/h以上)                      格納容器へのスプレイ容量の最大値は、重大事故等対策有効性評価の中で、大LOCA+ECCS注入失敗+格納容器スプレイ失敗の注水量が <math>\square</math> m<sup>3</sup>/hである。                      送水車は、これを上回る容量 ( <math>\square</math> m<sup>3</sup>/h/台) とする。</li> </ul> <p>(4) 復水ビットへ補給する場合の容量 ( <math>\square</math> m<sup>3</sup>/h以上)                      全交流電源喪失+RCP シール LOCA 時に必要となる復水ビットへの補給容量については、ストレステスト報告書および審査資料の中において、復水ビット水の枯渇後の崩壊熱に応じた水量として <math>\square</math> m<sup>3</sup>/h を設定しており、解析の結果、蒸気発生器による炉心冷却の健全性は確保されることが確認できている。                      送水車は、これを上回る容量 ( <math>\square</math> m<sup>3</sup>/h/台) とする。</p> <p>2. 吐出圧力</p> <p>(1) 使用済燃料ビットへ注水する場合の吐出圧力                      使用済燃料ビットへの注水流量に対する必要吐出圧力は、ホースの圧力損失、静水頭(最大E.L.差)を基に設定する。送水車の必要吐出圧力は、最も高いところで以下のとおり <math>\square</math> MPaとなる。</p> <div data-bbox="403 986 801 1077" style="margin-left: 40px;"> <table style="border-collapse: collapse;"> <tr> <td style="padding-right: 10px;">ホース圧力損失</td> <td style="border: 1px solid black; width: 30px; height: 15px; display: inline-block;"></td> <td style="padding-left: 5px;">MPa</td> </tr> <tr> <td>静水頭</td> <td style="border: 1px solid black; width: 30px; height: 15px; display: inline-block;"></td> <td style="padding-left: 5px;">MPa</td> </tr> <tr> <td>合計</td> <td style="border: 1px solid black; width: 30px; height: 15px; display: inline-block;"></td> <td style="padding-left: 5px;">MPa</td> </tr> </table> </div> <p>これを上回る吐出圧 ( <math>\square</math> MPa) の送水車で <math>\square</math> m<sup>3</sup>/hを注水可能な設計とする。</p> <p>(2) 使用済燃料ビットへスプレイする場合の吐出圧力                      使用済燃料ビットへの注水流量に対する必要吐出圧力は、ホースの圧力損失、静水頭(最大E.L.差)、スプレイヘッド必要圧力を基に設定する。送水車の必要吐出圧力は、最も高いところで以下のとおり <math>\square</math> MPaとなる。</p> </div>	ホース圧力損失		MPa	静水頭		MPa	合計		MPa		
ホース圧力損失		MPa									
静水頭		MPa									
合計		MPa									
枠囲みの範囲は機密に係る事項ですので公開することはできません。											

赤字：設備、運用又は体制の相違（設計方針の相違）  
 青字：記載箇所又は記載内容の相違（記載方針の相違）  
 緑字：記載表現、設備名称の相違（実質的な相違なし）

第50条 原子炉格納容器の過圧破損を防止するための設備

大飯発電所3 / 4号炉	泊発電所3号炉	相違理由																														
<div data-bbox="255 277 954 399"> <table border="0"> <tr><td>ホース圧力損失</td><td>□</td><td>MPa</td></tr> <tr><td>静水頭</td><td>□</td><td>MPa</td></tr> <tr><td>スプレーヘッド必要圧力</td><td>□</td><td>MPa</td></tr> <tr><td>合計</td><td>□</td><td>MPa</td></tr> </table> </div> <p data-bbox="331 432 931 453">これを上回る吐出圧（□MPa）の送水車で□m<sup>3</sup>/hをスプレー可能な設計とする。</p> <p data-bbox="286 491 618 512">(3) 仮設組立式水槽へ補給する場合の吐出圧力</p> <p data-bbox="315 520 947 600">原子炉への注水又は原子炉格納容器内へスプレーする場合に使用する仮設組立式水槽への補給流量に対する必要吐出は、ホースの圧力損失、静水頭(最大E.L.差)を基に設定する。送水車の必要吐出圧力は、最も高いところで以下のとおり□MPaとなる。</p> <div data-bbox="412 635 797 722"> <table border="0"> <tr><td>ホース圧力損失</td><td>□</td><td>MPa</td></tr> <tr><td>静水頭</td><td>□</td><td>MPa</td></tr> <tr><td>合計</td><td>□</td><td>MPa</td></tr> </table> </div> <p data-bbox="331 756 909 777">これを上回る吐出圧（□MPa）の送水車で□m<sup>3</sup>/hを補給可能な設計とする。</p> <p data-bbox="286 815 589 836">(4) 復水ビットへ補給する場合の吐出圧力</p> <p data-bbox="315 844 947 925">復水ビットへの注水流量に対する必要吐出圧力は、ホースの圧力損失、静水頭(最大E.L.差)を基に設定する。送水車の必要吐出圧力は、最も高いところで以下のとおり□MPaとなる。</p> <div data-bbox="412 960 797 1058"> <table border="0"> <tr><td>ホース圧力損失</td><td>□</td><td>MPa</td></tr> <tr><td>静水頭</td><td>□</td><td>MPa</td></tr> <tr><td>合計</td><td>□</td><td>MPa</td></tr> </table> </div> <p data-bbox="331 1099 909 1120">これを上回る吐出圧（□MPa）の送水車で□m<sup>3</sup>/hを補給可能な設計とする。</p> <p data-bbox="264 1131 387 1152">3. 最高使用圧力</p> <p data-bbox="293 1160 947 1211">送水車で最大必要吐出圧は□MPaであり、消防法に適合する使用圧力□MPa以下の□MPaを最高使用圧力とする。</p> <div data-bbox="322 1291 848 1321" style="border: 1px solid black; padding: 2px;"> <p>枠囲みの範囲は機密に係る事項ですので公開することはできません。</p> </div>	ホース圧力損失	□	MPa	静水頭	□	MPa	スプレーヘッド必要圧力	□	MPa	合計	□	MPa	ホース圧力損失	□	MPa	静水頭	□	MPa	合計	□	MPa	ホース圧力損失	□	MPa	静水頭	□	MPa	合計	□	MPa		
ホース圧力損失	□	MPa																														
静水頭	□	MPa																														
スプレーヘッド必要圧力	□	MPa																														
合計	□	MPa																														
ホース圧力損失	□	MPa																														
静水頭	□	MPa																														
合計	□	MPa																														
ホース圧力損失	□	MPa																														
静水頭	□	MPa																														
合計	□	MPa																														

赤字：設備、運用又は体制の相違（設計方針の相違）  
 青字：記載箇所又は記載内容の相違（記載方針の相違）  
 緑字：記載表現、設備名称の相違（実質的な相違なし）

第50条 原子炉格納容器の過圧破損を防止するための設備

大飯発電所3 / 4号炉	泊発電所3号炉	相違理由
<div data-bbox="255 277 954 1139" style="border: 1px solid black; padding: 10px;"> <p>4. 最高使用温度                      送水車の最高使用温度は、水源である海水の温度及び補給先である復水ピットの最高使用温度が <input type="text"/>℃であり、同仕様で設計し、<input type="text"/>℃とする。</p> <p>5. 原動機出力                      送水車の原動機出力は、消防法に適合した送水車を配備することから、その原動機出力が <input type="text"/>kWであり、原動機出力を <input type="text"/>kW以上とする。</p> </div> <div data-bbox="344 1174 878 1216" style="border: 1px solid black; padding: 5px; margin-top: 20px;"> <p>枠囲みの範囲は機密に係る事項ですので公開することはできません。</p> </div>		



泊発電所3号炉 SA基準適合性 比較表

赤字：設備、運用又は体制の相違（設計方針の相違）  
 青字：記載箇所又は記載内容の相違（記載方針の相違）  
 緑字：記載表現、設備名称の相違（実質的な相違なし）

第50条 原子炉格納容器の過圧破損を防止するための設備

大飯発電所3 / 4号炉	泊発電所3号炉	相違理由
<p>50-5 系統図</p>	<p>50-6 単線結線図</p>	

赤字：設備、運用又は体制の相違（設計方針の相違）  
 青字：記載箇所又は記載内容の相違（記載方針の相違）  
 緑字：記載表現、設備名称の相違（実質的な相違なし）

大飯発電所3/4号炉	泊発電所3号炉	相違理由
<p style="text-align: center;">重大事故等対処設備の電源構成図</p>	<p style="text-align: center;">図 50-6-1 交流電源単線結線図</p> <p style="text-align: right;">                 #1：常設代替交流電源設備の主要設備                  #2：可搬型代替交流電源設備の主要設備                  #3：代替炉内電気設備の主要設備             </p>	<p>相違理由</p>
50-5-6	50-6-2	

泊発電所3号炉 SA基準適合性 比較表

赤字：設備、運用又は体制の相違（設計方針の相違）  
 青字：記載箇所又は記載内容の相違（記載方針の相違）  
 緑字：記載表現、設備名称の相違（実質的な相違なし）

第50条 原子炉格納容器の過圧破損を防止するための設備

大飯発電所3/4号炉	泊発電所3号炉	相違理由
<p>50-2 配置図 3号炉</p>	<p>50-7 接続図</p>	

赤字：設備、運用又は体制の相違（設計方針の相違）  
 青字：記載箇所又は記載内容の相違（記載方針の相違）  
 緑字：記載表現、設備名称の相違（実質的な相違なし）

第50条 原子炉格納容器の過圧破損を防止するための設備

大飯発電所3/4号炉	泊発電所3号炉	相違理由
<div data-bbox="183 199 1008 1356" style="border: 2px solid black; width: 100%; height: 100%;"></div> <div data-bbox="183 1364 757 1396" style="border: 1px solid black; padding: 2px;"> <p>枠囲みの範囲は機密に係る事項ですので公開することはできません。</p> </div>	<div data-bbox="1131 279 1904 1292" style="text-align: center;"> </div> <p style="text-align: center;">図50-7-1 接続図（格納容器内自然対流冷却）</p>	

赤字：設備、運用又は体制の相違（設計方針の相違）  
 青字：記載箇所又は記載内容の相違（記載方針の相違）  
 緑字：記載表現、設備名称の相違（実質的な相違なし）

第50条 原子炉格納容器の過圧破損を防止するための設備

大飯発電所3 / 4号炉	泊発電所3号炉	相違理由
<div data-bbox="188 199 1010 1361" style="border: 2px solid black; height: 728px; width: 367px;"></div> <div data-bbox="188 1366 759 1394" style="border: 1px solid black; padding: 2px;">                     枠囲みの範囲は機密に係る事項ですので公開することはできません。                 </div> <div data-bbox="949 1382 1016 1404" style="text-align: right;">                     50-2-10                 </div>		<p>【対応手順・設備の相違による資料の相違】                      手順等が相違するため比較資料なし(手順の相違については本文にて説明)</p>

赤字：設備、運用又は体制の相違（設計方針の相違）  
 青字：記載箇所又は記載内容の相違（記載方針の相違）  
 緑字：記載表現、設備名称の相違（実質的な相違なし）

第50条 原子炉格納容器の過圧破損を防止するための設備

大飯発電所3 / 4号炉	泊発電所3号炉	相違理由
<div style="border: 2px solid black; width: 100%; height: 100%;"></div>		<p>【対応手順・設備の相違による資料の相違】                      手順等が相違するため比較資料なし(手順の相違については本文にて説明)</p>
<p>枠囲みの範囲は機密に係る事項ですので公開することはできません。</p>	<p>50-2-11</p>	

赤字：設備、運用又は体制の相違（設計方針の相違）  
 青字：記載箇所又は記載内容の相違（記載方針の相違）  
 緑字：記載表現、設備名称の相違（実質的な相違なし）

第50条 原子炉格納容器の過圧破損を防止するための設備

大飯発電所3/4号炉	泊発電所3号炉	相違理由
<div data-bbox="183 199 1008 1359" style="border: 2px solid black; height: 727px; width: 368px; margin: 10px auto;"></div> <div data-bbox="197 1369 770 1401" style="border: 1px solid black; padding: 2px; margin-top: 5px;">                     枠囲みの範囲は機密に係る事項ですので公開することはできません。                 </div>		<p>【記載表現の相違】                      電源の対稱電源4.57条資料57-8 可搬型代替電源車、可搬型直流電源用発電機及び可搬型直流変換器接続に関する説明書にて記載している(女川と同様)</p>

50-2-14

赤字：設備、運用又は体制の相違（設計方針の相違）  
 青字：記載箇所又は記載内容の相違（記載方針の相違）  
 緑字：記載表現、設備名称の相違（実質的な相違なし）

第50条 原子炉格納容器の過圧破損を防止するための設備

大飯発電所3/4号炉	泊発電所3号炉	相違理由
<div data-bbox="188 201 1010 1358" style="border: 2px solid black; height: 725px; width: 367px; margin: 10px auto;"></div> <div data-bbox="197 1366 768 1398" style="border: 1px solid black; padding: 2px; margin-top: 5px;">                     枠囲みの範囲は機密に係る事項ですので公開することはできません。                 </div> <div data-bbox="949 1382 1016 1404" style="text-align: right; margin-top: 5px;">                     50-2-15                 </div>		<p>【記載表現の相違】                      電源の対稱電源4.57条資料57-8 可搬型代替電源車、可搬型直流電源用発電機及び可搬型直流変換器接続に関する説明書にて記載している(女川と同様)</p>



泊発電所3号炉 SA基準適合性 比較表

赤字：設備、運用又は体制の相違（設計方針の相違）  
 青字：記載箇所又は記載内容の相違（記載方針の相違）  
 緑字：記載表現、設備名称の相違（実質的な相違なし）

第50条 原子炉格納容器の過圧破損を防止するための設備

大飯発電所3/4号炉	泊発電所3号炉	相違理由
<p>50-2 配置図 3号炉</p>	<p>50-8 保管場所図</p>	

赤字：設備、運用又は体制の相違（設計方針の相違）  
 青字：記載箇所又は記載内容の相違（記載方針の相違）  
 緑字：記載表現、設備名称の相違（実質的な相違なし）

第50条 原子炉格納容器の過圧破損を防止するための設備

大飯発電所3 / 4号炉	泊発電所3号炉	相違理由
<div data-bbox="190 199 1008 1364" style="border: 2px solid black; width: 100%; height: 100%;"></div> <div data-bbox="190 1364 750 1396" style="border: 1px solid black; padding: 2px;">                     枠囲みの範囲は機密に係る事項ですので公開することはできません。                 </div> <div data-bbox="952 1380 1019 1404" style="text-align: right;">                     50-2-9                 </div>		

赤字：設備、運用又は体制の相違（設計方針の相違）  
 青字：記載箇所又は記載内容の相違（記載方針の相違）  
 緑字：記載表現、設備名称の相違（実質的な相違なし）

大飯発電所 3 / 4 号炉	泊発電所 3 号炉	相違理由															
	<p><b>【凡例】</b></p> <ul style="list-style-type: none"> <li>保管場所</li> <li>可搬型大型送水ポンプ車</li> <li>ホース延長・回収車 (送水車用)</li> <li>原子炉補助建屋からの離隔距離 ※</li> </ul> <p>※：原子炉補助建屋、原子炉建屋又はディーゼルの発電機建屋のうち、可搬型重大事故等対策設備に最も近接している原子炉補助建屋を代表して記載している。          ※1：故障時のバックアップ          ※2：保守経路による特設路外側のバックアップ</p> <table border="1"> <thead> <tr> <th>保管場所</th> <th>分類</th> <th>原子炉補助建屋からの離隔距離</th> </tr> </thead> <tbody> <tr> <td>2号炉東側31mエリア(a)</td> <td>n</td> <td>約130m※</td> </tr> <tr> <td>51m倉庫車庫エリア</td> <td>n</td> <td>約560m※</td> </tr> <tr> <td>2号炉東側31mエリア(b)</td> <td>α</td> <td>約30m</td> </tr> <tr> <td>緊急時対策所エリア</td> <td>α</td> <td>約340m</td> </tr> </tbody> </table> <p>※：2設備あるうち、最近距離を記載</p> <p>#3：3号炉          R/B：原子炉建屋          A/B：原子炉補助建屋          DG/B：ディーゼルの発電機建屋</p>	保管場所	分類	原子炉補助建屋からの離隔距離	2号炉東側31mエリア(a)	n	約130m※	51m倉庫車庫エリア	n	約560m※	2号炉東側31mエリア(b)	α	約30m	緊急時対策所エリア	α	約340m	
保管場所	分類	原子炉補助建屋からの離隔距離															
2号炉東側31mエリア(a)	n	約130m※															
51m倉庫車庫エリア	n	約560m※															
2号炉東側31mエリア(b)	α	約30m															
緊急時対策所エリア	α	約340m															

赤字：設備、運用又は体制の相違（設計方針の相違）  
 青字：記載箇所又は記載内容の相違（記載方針の相違）  
 緑字：記載表現、設備名称の相違（実質的な相違なし）

大飯発電所3/4号炉

泊発電所3号炉

相違理由

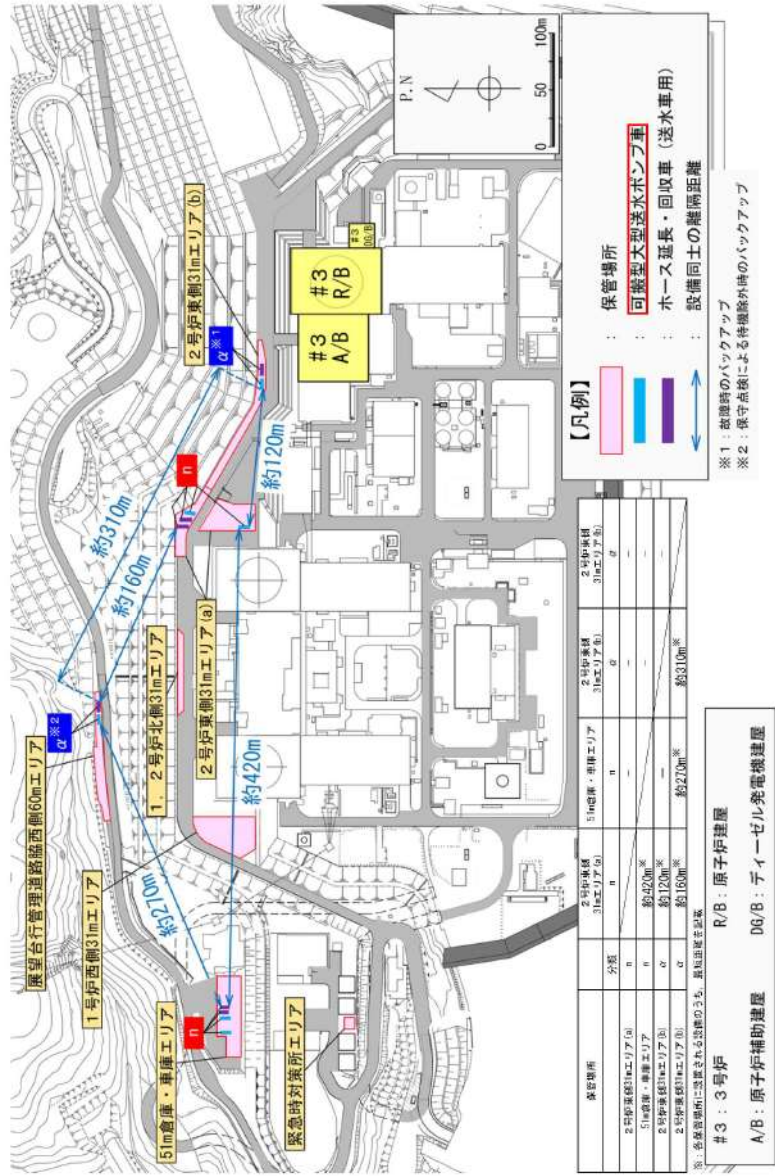

赤字：設備、運用又は体制の相違（設計方針の相違）  
 青字：記載箇所又は記載内容の相違（記載方針の相違）  
 緑字：記載表現、設備名称の相違（実質的な相違なし）

大飯発電所3/4号炉	泊発電所3号炉	相違理由															
	<p>保管場所</p> <table border="1"> <tr> <td>2号炉北側31mエリア(a)</td> <td>分機</td> <td>格納水ポンプ建屋内の設計基準事故対応設備からの距離</td> </tr> <tr> <td>5m倉庫・車庫エリア</td> <td>n</td> <td>約360m*</td> </tr> <tr> <td>2号炉東側31mエリア(b)</td> <td>n</td> <td>約710m*</td> </tr> <tr> <td>原簿台行管理道路脇西側60mエリア</td> <td>o</td> <td>約270m*</td> </tr> <tr> <td>原簿台行管理道路脇西側60mエリア</td> <td>o</td> <td>約560m*</td> </tr> </table> <p>※：各保管場所に設置される設備のうち、最短期間を記載</p> <p>R/B：原子炉建屋          A/B：原子炉補助建屋 DG/B：ディーゼル発電機建屋</p> <p>【凡例】</p> <ul style="list-style-type: none"> <li>赤色：保管場所</li> <li>青色：原子炉補機冷却海水ポンプ</li> <li>緑色：可搬型大型送水ポンプ車</li> <li>紫色：ホース延長・回収車（送水専用）</li> <li>緑色：原子炉補機冷却海水ポンプからの離隔距離</li> </ul> <p>※1：稼働時のバックアップ          ※2：保守状態による稼働除外時のバックアップ</p>	2号炉北側31mエリア(a)	分機	格納水ポンプ建屋内の設計基準事故対応設備からの距離	5m倉庫・車庫エリア	n	約360m*	2号炉東側31mエリア(b)	n	約710m*	原簿台行管理道路脇西側60mエリア	o	約270m*	原簿台行管理道路脇西側60mエリア	o	約560m*	
2号炉北側31mエリア(a)	分機	格納水ポンプ建屋内の設計基準事故対応設備からの距離															
5m倉庫・車庫エリア	n	約360m*															
2号炉東側31mエリア(b)	n	約710m*															
原簿台行管理道路脇西側60mエリア	o	約270m*															
原簿台行管理道路脇西側60mエリア	o	約560m*															

泊発電所3号炉 SA基準適合性 比較表

赤字：設備、運用又は体制の相違（設計方針の相違）  
 青字：記載箇所又は記載内容の相違（記載方針の相違）  
 緑字：記載表現、設備名称の相違（実質的な相違なし）

第50条 原子炉格納容器の過圧破損を防止するための設備

大飯発電所3/4号炉	泊発電所3号炉	相違理由
	50-9 アクセスルート図	<p>【記載表現の相違】                      女川の資料構成に合わせ技術的能力1.0.2 アクセスルートの資料内容に基づき設備調査資料として構成している。</p>

赤字：設備、運用又は体制の相違（設計方針の相違）  
 青字：記載箇所又は記載内容の相違（記載方針の相違）  
 緑字：記載表現、設備名称の相違（実質的な相違なし）

大飯発電所 3 / 4 号炉	泊発電所 3 号炉	相違理由
	<p style="text-align: center;">50-9-1</p> <p style="text-align: right;">保管理所及びアクセスルート図</p>	

赤字：設備、運用又は体制の相違（設計方針の相違）  
 青字：記載箇所又は記載内容の相違（記載方針の相違）  
 緑字：記載表現、設備名称の相違（実質的な相違なし）

大飯発電所 3 / 4 号炉	泊発電所 3 号炉	相違理由
	<div data-bbox="1131 209 1809 1257" style="border: 2px solid black; width: 100%; height: 100%;"></div> <div data-bbox="1809 651 1832 847" style="writing-mode: vertical-rl; position: absolute; right: 10px; top: 50%; transform: translateY(-50%);">地震時のアクセスルート図</div> <div data-bbox="1417 1321 1906 1342" style="text-align: center; margin-top: 20px;"> <span style="border: 1px solid black; display: inline-block; width: 15px; height: 10px;"></span> 枠囲みの内容は機密情報に属しますので公開できません。                 </div> <div data-bbox="1473 1361 1541 1382" style="text-align: center;">50-9-2</div>	



赤字：設備、運用又は体制の相違（設計方針の相違）  
 青字：記載箇所又は記載内容の相違（記載方針の相違）  
 緑字：記載表現、設備名称の相違（実質的な相違なし）

大飯発電所3/4号炉	泊発電所3号炉	相違理由
	<p style="text-align: center;">沖波時のアクセスルート図</p>	
	50-9-3	

赤字：設備、運用又は体制の相違（設計方針の相違）  
 青字：記載箇所又は記載内容の相違（記載方針の相違）  
 緑字：記載表現、設備名称の相違（実質的な相違なし）

大飯発電所 3 / 4 号炉	泊発電所 3 号炉	相違理由
	<div data-bbox="1128 209 1809 1254" style="border: 2px solid black; width: 100%; height: 100%;"></div> <div data-bbox="1809 651 1839 847" style="writing-mode: vertical-rl; position: absolute; right: 10px; top: 50%; transform: translateY(-50%);">                     火災時のアクセスルート図                 </div> <div data-bbox="1417 1321 1906 1342" style="text-align: center; margin-top: 20px;"> <span style="border: 1px solid black; display: inline-block; width: 15px; height: 10px;"></span> 枠囲みの内容は機密情報に属しますので公開できません。                 </div> <div data-bbox="1473 1361 1541 1382" style="text-align: center;">                     50-9-4                 </div>	

泊発電所3号炉 SA基準適合性 比較表

赤字：設備、運用又は体制の相違（設計方針の相違）  
 青字：記載箇所又は記載内容の相違（記載方針の相違）  
 緑字：記載表現、設備名称の相違（実質的な相違なし）

第50条 原子炉格納容器の過圧破損を防止するための設備

大飯発電所3/4号炉	泊発電所3号炉	相違理由
	<div data-bbox="1128 209 1809 1310" style="border: 2px solid black; width: 100%; height: 100%;"></div> <div data-bbox="1420 1321 1906 1342" style="text-align: center; margin-top: 10px;"> <span style="border: 1px solid black; display: inline-block; width: 15px; height: 10px;"></span> 枠囲みの内容は機密情報に属しますので公開できません。                 </div> <div data-bbox="1480 1361 1541 1382" style="text-align: center; margin-top: 10px;">50-9-5</div>	

赤字：設備、運用又は体制の相違（設計方針の相違）  
 青字：記載箇所又は記載内容の相違（記載方針の相違）  
 緑字：記載表現、設備名称の相違（実質的な相違なし）

第50条 原子炉格納容器の過圧破損を防止するための設備

大飯発電所3/4号炉	泊発電所3号炉	相違理由
	<div data-bbox="1133 217 1812 1305" style="border: 2px solid black; width: 100%; height: 100%;"></div> <div data-bbox="1417 1321 1906 1342" style="text-align: right; margin-top: 10px;"> <span style="border: 1px solid black; display: inline-block; width: 15px; height: 10px;"></span> 枠囲みの内容は機密情報に属しますので公開できません。                 </div>	

50-9-6

泊発電所3号炉 SA基準適合性 比較表

赤字：設備、運用又は体制の相違（設計方針の相違）  
 青字：記載箇所又は記載内容の相違（記載方針の相違）  
 緑字：記載表現、設備名称の相違（実質的な相違なし）

第50条 原子炉格納容器の過圧破損を防止するための設備

大飯発電所3/4号炉	泊発電所3号炉	相違理由
	<div data-bbox="1140 217 1809 1305" style="border: 2px solid black; width: 100%; height: 100%;"></div> <div data-bbox="1417 1321 1906 1342" style="text-align: right; margin-top: 10px;"> <span style="border: 1px solid black; display: inline-block; width: 15px; height: 10px;"></span> 枠囲みの内容は機密情報に属しますので公開できません。                 </div>	

50-9-7

泊発電所3号炉 SA基準適合性 比較表

赤字：設備、運用又は体制の相違（設計方針の相違）  
 青字：記載箇所又は記載内容の相違（記載方針の相違）  
 緑字：記載表現、設備名称の相違（実質的な相違なし）

第50条 原子炉格納容器の過圧破損を防止するための設備

大飯発電所3/4号炉	女川原子力発電所2号炉	泊発電所3号炉	相違理由
<p data-bbox="248 740 456 799">大飯に該当資料なし</p>	<p data-bbox="804 767 1200 815">50-13 大容量送水ポンプ（タイプI）の構造について</p>	<p data-bbox="1420 780 1850 802">50-11 可搬型大型送水ポンプ車の構造について</p>	<p data-bbox="1973 724 2163 858">General 本補足説明資料は大飯3/4号炉にないため、女川2号炉との比較を行った。</p>

赤字：設備、運用又は体制の相違（設計方針の相違）  
 青字：記載箇所又は記載内容の相違（記載方針の相違）  
 緑字：記載表現、設備名称の相違（実質的な相違なし）

大飯発電所 3 / 4 号炉	女川原子力発電所 2 号炉	泊発電所 3 号炉	相違理由
	<p data-bbox="808 140 1225 164">大容量送水ポンプ（タイプ I）の構造について</p> <p data-bbox="710 197 1326 277">大容量送水ポンプ（タイプ I）は、図 50-13-1 に示すとおり増圧ポンプ 1 台、付属水中ポンプ 2 台、ディーゼルエンジン 1 台等で構成される。</p> <p data-bbox="710 400 1326 480">大容量送水ポンプ（タイプ I）は、付属水中ポンプ及び増圧ポンプをディーゼルエンジンにて駆動する設計であり、外部電源が不要な設計である。</p> <p data-bbox="710 488 1326 568">大容量送水ポンプ（タイプ I）は、淡水又は海水を付属水中ポンプにて取水した後、ホースを介して増圧ポンプへと送水し、加圧した水を各注水先へ送水する。</p> <p data-bbox="710 576 1326 624">なお、付属水中ポンプの吸込部にはストレーナを設置し、異物の流入を防止する設計としている。</p> <div data-bbox="719 707 1317 1098" style="border: 1px solid black; height: 245px; margin: 10px 0;"></div> <p data-bbox="808 1102 1225 1118">図 50-13-1 大容量送水ポンプ（タイプ I）の構造概要図</p> <div data-bbox="882 1342 1296 1366" style="border: 1px solid black; padding: 2px; margin: 10px 0;">枠囲みの内容は商業機密の観点から公開できません。</div>	<p data-bbox="1451 140 1816 164">可搬型大型送水ポンプ車の構造について</p> <p data-bbox="1339 197 1955 277">可搬型大型送水ポンプ車は、図 50-11-1 に示すとおり送水ポンプ 1 台、付属水中ポンプ 1 台、車両のディーゼルエンジン 1 台等で構成される。</p> <p data-bbox="1339 400 1955 480">可搬型大型送水ポンプ車は、送水ポンプ及び付属水中ポンプを車両のディーゼルエンジンにて駆動する設計であり、外部電源が不要な設計である。</p> <p data-bbox="1339 488 1955 568">可搬型大型送水ポンプ車は、淡水又は海水を付属水中ポンプにて取水した後、可搬型ホースを介して送水ポンプへと送水し、加圧した水を各注水先へ送水する。</p> <p data-bbox="1339 576 1955 624">なお、付属水中ポンプの吸込部にはストレーナを設置し、異物の流入を防止する設計としている。</p> <div data-bbox="1346 699 1951 1174" style="border: 1px solid black; height: 298px; margin: 10px 0;"></div> <p data-bbox="1420 1190 1877 1206">図 50-11-1 可搬型大型送水ポンプ車の構造概要図</p> <div data-bbox="1352 1230 1924 1254" style="border: 1px solid black; padding: 2px; margin: 10px 0;">枠囲みの内容は機密情報に属しますので公開できません。</div>	<p data-bbox="1973 229 2063 245">設備の相違</p> <ul data-bbox="1973 261 2163 365" style="list-style-type: none"> <li>・泊の可搬型大型送水ポンプ車は水中ポンプ 1 台で定格容量を確保できる設計である。</li> </ul> <p data-bbox="1973 405 2063 421">設備の相違</p> <ul data-bbox="1973 437 2163 572" style="list-style-type: none"> <li>・泊の可搬型大型送水ポンプ車は消防自動車同様に車両のエンジンをポンプの駆動源としている。</li> </ul>

赤字：設備、運用又は体制の相違（設計方針の相違）  
 青字：記載箇所又は記載内容の相違（記載方針の相違）  
 緑字：記載表現、設備名称の相違（実質的な相違なし）

第50条 原子炉格納容器の過圧破損を防止するための設備

大飯発電所3/4号炉	泊発電所3号炉	相違理由
<p>48-8 格納容器再循環ユニットによる自然対流冷却について</p>	<p>50-13 格納容器再循環ユニットによる自然対流冷却について</p>	



赤字：設備、運用又は体制の相違（設計方針の相違）  
 青字：記載箇所又は記載内容の相違（記載方針の相違）  
 緑字：記載表現、設備名称の相違（実質的な相違なし）

第50条 原子炉格納容器の過圧破損を防止するための設備

大飯発電所3/4号炉	泊発電所3号炉	相違理由
<p><u>格納容器再循環ユニットによる自然対流冷却について</u></p> <p>大飯3、4号炉の格納容器再循環ユニットによる自然対流冷却について次頁以降に示す。</p>	<p><u>格納容器再循環ユニットによる自然対流冷却について</u></p> <p>泊3号炉の格納容器再循環ユニットによる自然対流冷却について次頁以降に示す。</p>	

赤字：設備、運用又は体制の相違（設計方針の相違）  
 青字：記載箇所又は記載内容の相違（記載方針の相違）  
 緑字：記載表現、設備名称の相違（実質的な相違なし）

第50条 原子炉格納容器の過圧破損を防止するための設備

大飯発電所3/4号炉	泊発電所3号炉	相違理由
<p style="text-align: center;">目次</p> <p>1章 はじめに</p> <p>2章 格納容器再循環ユニット冷却コイル性能試験概要（PWR5電力共研概要）</p> <p>2.1 性能試験</p> <p>2.1.1 試験に使用する冷却コイルの選定</p> <p>2.1.2 測定項目の設定</p> <p>2.1.3 試験装置</p> <p>2.1.4 試験条件の設定</p> <p>2.1.5 試験方法</p> <p>3章 除熱評価式の試験による検証</p> <p>3.1 除熱評価式について</p> <p>3.2 除熱評価式の試験での検証</p> <p>4章 自然対流冷却時の除熱性能評価</p> <p>4.1 ドラフト力計算について</p> <p>4.2 系統圧力損失計算について</p> <p>4.3 冷却コイル部の凝縮水等の影響考慮について</p> <p>4.4 自然対流冷却の除熱量評価手順について</p> <p>5章 除熱量計算手法の妥当性に関する考察</p> <p>5.1 不凝縮性ガスの除熱性能に対する影響について</p> <p>5.2 冷却コイル性能試験範囲の妥当性について</p> <p>6章 まとめ</p> <p>（添付資料）</p> <p>参考資料-0 格納容器再循環ユニットの実機条件</p> <p>参考資料-1 冷却コイル高さ方向での熱容量の余裕について</p> <p>参考資料-2 エアロゾルによる自然対流冷却除熱性能劣化について</p> <p>参考資料-3 格納容器再循環ユニットのダクト内外での水素燃焼影響について</p> <p>参考資料-4 格納容器再循環ユニットによる自然対流冷却時の沸騰防止運用について</p> <p>参考資料-5 OECD PANDA 試験の知見を踏まえた自然対流冷却に関する考察</p> <p>参考資料-6 格納容器再循環ユニットによる格納容器内自然対流冷却の水素影響について</p> <p>参考資料-7 実機における凝縮水の影響について</p> <p>参考資料-8 格納容器再循環ユニットによる自然対流冷却発生プロセスの定量的考察</p> <p>参考資料-9 格納容器再循環ユニットラフフィルタ撤去による影響について</p>	<p style="text-align: center;">目次</p> <p>1章 はじめに</p> <p>2章 格納容器再循環ユニット冷却コイル性能試験概要（PWR5電力共研概要）</p> <p>2.1 性能試験</p> <p>2.1.1 試験に使用する冷却コイルの選定</p> <p>2.1.2 測定項目の設定</p> <p>2.1.3 試験装置</p> <p>2.1.4 試験条件の設定</p> <p>2.1.5 試験方法</p> <p>3章 除熱評価式の試験による検証</p> <p>3.1 除熱評価式について</p> <p>3.2 除熱評価式の試験での検証</p> <p>4章 自然対流冷却時の除熱性能評価</p> <p>4.1 ドラフト力計算について</p> <p>4.2 系統圧力損失計算について</p> <p>4.3 冷却コイル部の凝縮水等の影響考慮について</p> <p>4.4 自然対流冷却の除熱量評価手順について</p> <p>5章 除熱量計算手法の妥当性に関する考察</p> <p>5.1 不凝縮性ガスの除熱性能に対する影響について</p> <p>5.2 冷却コイル性能試験範囲の妥当性について</p> <p>6章 まとめ</p> <p>（添付資料）</p> <p>参考資料-0 格納容器再循環ユニットの実機条件</p> <p>参考資料-1 冷却コイル高さ方向での熱容量の余裕について</p> <p>参考資料-2 エアロゾルによる自然対流冷却除熱性能劣化について</p> <p>参考資料-3 格納容器再循環ユニットのダクト内外での水素燃焼影響について</p> <p>参考資料-4 格納容器再循環ユニットによる自然対流冷却時の沸騰防止運用について</p> <p>参考資料-5 OECD PANDA 試験の知見を踏まえた自然対流冷却に関する考察</p> <p>参考資料-6 格納容器再循環ユニットによる格納容器内自然対流冷却の水素影響について</p> <p>参考資料-7 実機における凝縮水の影響について</p> <p>参考資料-8 格納容器再循環ユニットによる自然対流冷却発生プロセスの定量的考察</p> <p>参考資料-9 格納容器再循環ユニット粗フィルタ撤去による影響について</p>	<p>設備名称の相違</p>

赤字：設備、運用又は体制の相違（設計方針の相違）  
 青字：記載箇所又は記載内容の相違（記載方針の相違）  
 緑字：記載表現、設備名称の相違（実質的な相違なし）

第50条 原子炉格納容器の過圧破損を防止するための設備

大飯発電所3/4号炉	泊発電所3号炉	相違理由
<p>1章 審査会合指摘事項</p> <p>1.1 はじめに</p> <p>格納容器再循環ユニットは、原子炉冷却材喪失事故（LOCA）、全交流電源喪失（SBO）及び最終ヒートシンク喪失（LUHS）の事象の重量を想定するような重大事故発生時において、冷却水を通水し自然対流による格納容器気相部冷却を行うことにより、炉心及び格納容器の損傷防止を図る設備である。</p> <p>ここで、格納容器再循環ユニットは、自然対流冷却性能の観点から、自然対流冷却時に使用するA、D-格納容器再循環ユニットのラフフィルタを取外し、流路の圧力損失を低減することで、自然対流量を増大させている。</p> <p>本書は、ラフフィルタを取外した格納容器再循環ユニット冷却コイルの除熱評価式及び除熱評価式を検証するために実施した試験、並びに除熱評価式を用いた重大事故時における格納容器再循環ユニットによる自然対流冷却の除熱性能評価手順についてまとめたものであり、以下の構成としている。</p> <p>2章は、PWR5電力共研として実施した、格納容器再循環ユニット冷却コイルの性能試験の概要について述べる。</p> <p>3章は、冷却コイルの性能試験で得られた結果を踏まえた冷却コイル単体における除熱評価式の妥当性の検証結果について述べる。</p> <p>4章は、冷却コイル単体の除熱評価式を踏まえて、フィルタ・冷却コイル・ダクト等で構成される格納容器再循環ユニットにおける自然対流冷却時の除熱性能評価手法について述べる。</p> <p>5章は、除熱量評価手法の妥当性に関する考察を行った結果について述べる。</p> <p>2章 格納容器再循環ユニット冷却コイル性能試験概要（PWR5電力共研概要）</p> <p>重大事故時に格納容器内の圧力・温度を低減させ格納容器の破損を防止する格納容器再循環ユニットについて、冷却コイル性能を評価する除熱評価式の確認を行うため、実機サイズの冷却コイルによる冷却性能試験を実施した。また、発生した凝縮水による冷却コイル下段での混合ガス流路面積減少の影響について確認を行うために、コイル高さ方向での冷却性能の確認試験を行った。</p> <p>2.1 性能試験</p> <p>2.1.1 試験に使用する冷却コイルの選定</p> <p>本試験に使用する冷却コイルは、ハーフサーキット型で、奥行き方向8列、幅方向有効長500mm、高さ方向34チューブの冷却コイルを選定した。</p> <p>(1) 冷却コイル型式</p> <p>PWRプラントの格納容器再循環ユニット冷却コイルの型式では最も多く大飯発電所3、4号機でも使用しているハーフサーキット型を選定した。</p>	<p>1章 はじめに</p> <p>格納容器再循環ユニットは、原子炉冷却材喪失事故（LOCA）、全交流電源喪失（SBO）及び最終ヒートシンク喪失（LUHS）の事象の重量を想定するような重大事故発生時において、冷却水を通水し自然対流による格納容器気相部冷却を行うことにより、炉心及び格納容器の損傷防止を図る設備である。</p> <p>ここで、格納容器再循環ユニットは、自然対流冷却性能の観点から、自然対流冷却時に使用するC、D-格納容器再循環ユニットの粗フィルタを取外し、流路の圧力損失を低減することで、自然対流量を増大させている。</p> <p>本書は、粗フィルタを取外した格納容器再循環ユニット冷却コイルの除熱評価式及び除熱評価式を検証するために実施した試験、並びに除熱評価式を用いた重大事故時における格納容器再循環ユニットによる自然対流冷却の除熱性能評価手順についてまとめたものであり、以下の構成としている。</p> <p>2章は、PWR5電力共研として実施した、格納容器再循環ユニット冷却コイルの性能試験の概要について述べる。</p> <p>3章は、冷却コイルの性能試験で得られた結果を踏まえた冷却コイル単体における除熱評価式の妥当性の検証結果について述べる。</p> <p>4章は、冷却コイル単体の除熱評価式を踏まえて、冷却コイル・ダクト等で構成される格納容器再循環ユニットにおける自然対流冷却時の除熱性能評価手法について述べる。</p> <p>5章は、除熱量評価手法の妥当性に関する考察を行った結果について述べる。</p> <p>2章 格納容器再循環ユニット冷却コイル性能試験概要（PWR5電力共研概要）</p> <p>重大事故時に格納容器内の圧力・温度を低減させ格納容器の破損を防止する格納容器再循環ユニットについて、冷却コイル性能を評価する除熱評価式の確認を行うため、実機サイズの冷却コイルによる冷却性能試験を実施した。また、発生した凝縮水による冷却コイル下段での混合ガス流路面積減少の影響について確認を行うために、コイル高さ方向での冷却性能の確認試験を行った。</p> <p>2.1 性能試験</p> <p>2.1.1 試験に使用する冷却コイルの選定</p> <p>本試験に使用する冷却コイルは、ハーフサーキット型で、奥行き方向8列、幅方向有効長500mm、高さ方向34チューブの冷却コイルを選定した。</p> <p>(1) 冷却コイル型式</p> <p>PWRプラントの格納容器再循環ユニット冷却コイルの型式では最も多く泊発電所3号炉でも使用しているハーフサーキット型を選定した。</p>	<p>設備名称の相違</p>

赤字：設備、運用又は体制の相違（設計方針の相違）  
 青字：記載箇所又は記載内容の相違（記載方針の相違）  
 緑字：記載表現、設備名称の相違（実質的な相違なし）

第50条 原子炉格納容器の過圧破損を防止するための設備

大飯発電所3/4号炉	泊発電所3号炉	相違理由
<p>(2) 冷却コイルのサイズ</p> <p>水蒸気凝縮量が多い場合に、冷却コイル高さ方向での熱交換量に差が生じ（上部&gt;下部）、コイルの高さの高いものほどその差は大きいと考えられるため、PWRプラントで使用しているハーフサーキット型の冷却コイルのうち、最も有効高さの高いものを選定した。ただし、コイルの幅については、実機の流速分布と大きな差が出ない範囲として500mmとした。</p> <p>2. 1. 2 測定項目の設定</p> <p>測定項目は、重大事故時の条件下での除熱評価式の検証、及び凝縮水等による冷却コイル熱交換量への影響を評価できるように設定した。</p> <p style="text-align: center;">表2-1 測定項目の設定根拠</p> <div style="border: 1px solid black; width: 280px; height: 280px; margin: 0 auto;"></div> <p>2. 1. 3 試験装置</p> <div style="border: 1px solid black; width: 390px; height: 80px; margin: 0 auto;"></div> <p style="text-align: center; border: 1px solid black; padding: 2px;">枠囲みの範囲は機密に係る事項ですので公開することはできません。</p>	<p>(2) 冷却コイルのサイズ</p> <p>水蒸気凝縮量が多い場合に、冷却コイル高さ方向での熱交換量に差が生じ（上部&gt;下部）、コイルの高さの高いものほどその差は大きいと考えられるため、PWRプラントで使用しているハーフサーキット型の冷却コイルのうち、最も有効高さの高いものを選定した。ただし、コイルの幅については、実機の流速分布と大きな差が出ない範囲として500mmとした。</p> <p>2. 1. 2 測定項目の設定</p> <p>測定項目は、重大事故時の条件下での除熱評価式の検証、及び凝縮水等による冷却コイル熱交換量への影響を評価できるように設定した。</p> <p style="text-align: center;">表2-1 測定項目の設定根拠</p> <div style="border: 1px solid black; width: 370px; height: 370px; margin: 0 auto;"></div> <p>2. 1. 3 試験装置</p> <div style="border: 1px solid black; width: 390px; height: 100px; margin: 0 auto;"></div> <p style="text-align: center; border: 1px solid black; padding: 2px;">枠囲みの内容は機密情報に属しますので公開できません。</p>	

赤字：設備、運用又は体制の相違（設計方針の相違）  
 青字：記載箇所又は記載内容の相違（記載方針の相違）  
 緑字：記載表現、設備名称の相違（実質的な相違なし）

第50条 原子炉格納容器の過圧破損を防止するための設備

大飯発電所3 / 4号炉	泊発電所3号炉	相違理由
<div data-bbox="262 263 943 774" data-label="Image"> </div> <div data-bbox="376 778 815 802" data-label="Caption"> <p>図2-1 格納容器再循環ユニット冷却性能試験システム構成</p> </div> <div data-bbox="262 805 943 1228" data-label="Image"> </div> <div data-bbox="465 1233 725 1257" data-label="Caption"> <p>図2-2 試験装置内温度測定位置</p> </div> <div data-bbox="840 1233 902 1252" data-label="Text"> <p>→ 排気</p> </div> <div data-bbox="459 1273 909 1305" data-label="Text"> <p>枠囲みの範囲は機密に係る事項ですので公開することはできません。</p> </div>	<div data-bbox="1167 236 1848 746" data-label="Image"> </div> <div data-bbox="1279 751 1718 775" data-label="Caption"> <p>図2-1 格納容器再循環ユニット冷却性能試験システム構成</p> </div> <div data-bbox="1167 778 1848 1201" data-label="Image"> </div> <div data-bbox="1368 1206 1628 1230" data-label="Caption"> <p>図2-2 試験装置内温度測定位置</p> </div> <div data-bbox="1736 1206 1798 1225" data-label="Text"> <p>→ 排気</p> </div> <div data-bbox="1317 1316 1765 1340" data-label="Text"> <p>枠囲みの内容は機密情報に属しますので公開できません。</p> </div>	

赤字：設備、運用又は体制の相違（設計方針の相違）  
 青字：記載箇所又は記載内容の相違（記載方針の相違）  
 緑字：記載表現、設備名称の相違（実質的な相違なし）

第50条 原子炉格納容器の過圧破損を防止するための設備

大飯発電所3/4号炉	泊発電所3号炉	相違理由																																																
<p>2. 1. 4 試験条件の設定</p> <p>事故時と同様の空気と水蒸気の混合ガス環境下において冷却コイルでの除熱量、凝縮量等を実験により求め、除熱量評価式を検証した（実験条件 表2-2）。</p> <p>表2-2 再循環ユニット（冷却コイル）凝縮熱伝達実験条件</p> <table border="1" data-bbox="280 331 913 737"> <thead> <tr> <th>実験条件</th> <th>大飯3、4号機</th> </tr> </thead> <tbody> <tr><td>全圧</td><td>約 5.0~9.0ata*</td></tr> <tr><td>水蒸気分圧</td><td>約 3.6~7.6ata*</td></tr> <tr><td>温度</td><td>約 140~168℃*</td></tr> <tr><td>混合ガス流速</td><td>約 0.1~0.3m/sec</td></tr> <tr><td>冷却水入口温度</td><td>同左</td></tr> <tr><td>冷却水流量</td><td>11.75m³/hr/基</td></tr> <tr><td>冷却コイル型式</td><td>同左</td></tr> <tr><td>チューブ有効長さ</td><td>1.8m</td></tr> <tr><td>チューブ本数</td><td>30本</td></tr> <tr><td>列数</td><td>10列</td></tr> <tr><td>冷却コイル高さ</td><td>約 1.15m</td></tr> </tbody> </table> <p>※大飯3、4号機における格納容器圧力 1Pd~2Pd での値</p>	実験条件	大飯3、4号機	全圧	約 5.0~9.0ata*	水蒸気分圧	約 3.6~7.6ata*	温度	約 140~168℃*	混合ガス流速	約 0.1~0.3m/sec	冷却水入口温度	同左	冷却水流量	11.75m³/hr/基	冷却コイル型式	同左	チューブ有効長さ	1.8m	チューブ本数	30本	列数	10列	冷却コイル高さ	約 1.15m	<p>2. 1. 4 試験条件の設定</p> <p>事故時と同様の空気と水蒸気の混合ガス環境下において冷却コイルでの除熱量、凝縮量等を実験により求め、除熱量評価式を検証した（実験条件 表2-2）。</p> <p>表2-2 再循環ユニット（冷却コイル）凝縮熱伝達実験条件</p> <table border="1" data-bbox="1198 331 1854 758"> <thead> <tr> <th>実験条件</th> <th>泊3号炉</th> </tr> </thead> <tbody> <tr><td>全圧</td><td>約 3.9~6.9ata*</td></tr> <tr><td>水蒸気分圧</td><td>約 2.6~5.4ata*</td></tr> <tr><td>温度</td><td>約 128~155℃*</td></tr> <tr><td>混合ガス流速</td><td>約 0.2~0.3m/sec</td></tr> <tr><td>冷却水入口温度</td><td>同左</td></tr> <tr><td>冷却水流量</td><td>10.3m³/hr/基</td></tr> <tr><td>冷却コイル型式</td><td>同左</td></tr> <tr><td>チューブ有効長さ</td><td>1.3m</td></tr> <tr><td>チューブ本数</td><td>44本</td></tr> <tr><td>列数</td><td>8列</td></tr> <tr><td>冷却コイル高さ</td><td>約 1.68m</td></tr> </tbody> </table> <p>※泊3号炉における格納容器圧力 1Pd~2Pd での値</p>	実験条件	泊3号炉	全圧	約 3.9~6.9ata*	水蒸気分圧	約 2.6~5.4ata*	温度	約 128~155℃*	混合ガス流速	約 0.2~0.3m/sec	冷却水入口温度	同左	冷却水流量	10.3m³/hr/基	冷却コイル型式	同左	チューブ有効長さ	1.3m	チューブ本数	44本	列数	8列	冷却コイル高さ	約 1.68m	<p>設計の相違</p> <ul style="list-style-type: none"> <li>・格納容器設計により定まる全圧、水蒸気分圧、温度は、大飯3/4号炉と相違しているが、泊3号炉と同じ鋼製CVである伊方3号炉とは同条件である。</li> <li>・上記以外の各条件は、格納容器再循環ユニットの設計相違による相違であるが、設計相違を踏まえて格納容器内自然対流冷却の除熱性能を評価していることに相違はない。</li> </ul>
実験条件	大飯3、4号機																																																	
全圧	約 5.0~9.0ata*																																																	
水蒸気分圧	約 3.6~7.6ata*																																																	
温度	約 140~168℃*																																																	
混合ガス流速	約 0.1~0.3m/sec																																																	
冷却水入口温度	同左																																																	
冷却水流量	11.75m³/hr/基																																																	
冷却コイル型式	同左																																																	
チューブ有効長さ	1.8m																																																	
チューブ本数	30本																																																	
列数	10列																																																	
冷却コイル高さ	約 1.15m																																																	
実験条件	泊3号炉																																																	
全圧	約 3.9~6.9ata*																																																	
水蒸気分圧	約 2.6~5.4ata*																																																	
温度	約 128~155℃*																																																	
混合ガス流速	約 0.2~0.3m/sec																																																	
冷却水入口温度	同左																																																	
冷却水流量	10.3m³/hr/基																																																	
冷却コイル型式	同左																																																	
チューブ有効長さ	1.3m																																																	
チューブ本数	44本																																																	
列数	8列																																																	
冷却コイル高さ	約 1.68m																																																	
<p>表2-2 再循環ユニット（冷却コイル）凝縮熱伝達実験条件</p> <table border="1" data-bbox="376 901 907 1244"> <thead> <tr> <th>実験条件</th> <th>伊方3号機</th> </tr> </thead> <tbody> <tr><td>全圧</td><td>約 3.9~6.9ata*</td></tr> <tr><td>水蒸気分圧</td><td>約 2.6~5.4ata*</td></tr> <tr><td>温度</td><td>約 128~155℃*</td></tr> <tr><td>混合ガス流速</td><td>約 0.1~0.16m/sec</td></tr> <tr><td>冷却水入口温度</td><td>同左</td></tr> <tr><td>冷却水流量</td><td>13.3m³/hr/基</td></tr> <tr><td>冷却コイル型式</td><td>同左</td></tr> <tr><td>チューブ有効長さ</td><td>1.6m</td></tr> <tr><td>チューブ本数</td><td>34本</td></tr> <tr><td>列数</td><td>8列</td></tr> <tr><td>冷却コイル高さ</td><td>約 1.3m</td></tr> </tbody> </table> <p>※伊方3号機における格納容器圧力 1Pd~2Pd での値</p> <p>本記載は、伊方号炉の参考掲載</p>	実験条件	伊方3号機	全圧	約 3.9~6.9ata*	水蒸気分圧	約 2.6~5.4ata*	温度	約 128~155℃*	混合ガス流速	約 0.1~0.16m/sec	冷却水入口温度	同左	冷却水流量	13.3m³/hr/基	冷却コイル型式	同左	チューブ有効長さ	1.6m	チューブ本数	34本	列数	8列	冷却コイル高さ	約 1.3m																										
実験条件	伊方3号機																																																	
全圧	約 3.9~6.9ata*																																																	
水蒸気分圧	約 2.6~5.4ata*																																																	
温度	約 128~155℃*																																																	
混合ガス流速	約 0.1~0.16m/sec																																																	
冷却水入口温度	同左																																																	
冷却水流量	13.3m³/hr/基																																																	
冷却コイル型式	同左																																																	
チューブ有効長さ	1.6m																																																	
チューブ本数	34本																																																	
列数	8列																																																	
冷却コイル高さ	約 1.3m																																																	

赤字：設備、運用又は体制の相違（設計方針の相違）  
 青字：記載箇所又は記載内容の相違（記載方針の相違）  
 緑字：記載表現、設備名称の相違（実質的な相違なし）

第50条 原子炉格納容器の過圧破損を防止するための設備

大飯発電所3/4号炉	泊発電所3号炉	相違理由
<p>2. 1. 5 試験方法                      (1) 除熱量（凝縮熱伝達量）計測</p> <div data-bbox="147 231 1046 518" style="border: 2px solid black; height: 180px; width: 100%;"></div> <div data-bbox="465 630 913 657" style="border: 1px solid black; padding: 2px; width: fit-content; margin: 20px auto;">                         枠囲みの範囲は機密に係る事項ですので公開することはできません。                     </div>	<p>2. 1. 5 試験方法                      (1) 除熱量（凝縮熱伝達量）計測</p> <div data-bbox="1070 231 1960 510" style="border: 2px solid black; height: 175px; width: 100%;"></div> <div data-bbox="1288 561 1904 587" style="border: 1px solid black; padding: 2px; width: fit-content; margin: 20px auto;">                         枠囲みの内容は機密情報に属しますので公開できません。                     </div>	

赤字：設備、運用又は体制の相違（設計方針の相違）  
 青字：記載箇所又は記載内容の相違（記載方針の相違）  
 緑字：記載表現、設備名称の相違（実質的な相違なし）

第50条 原子炉格納容器の過圧破損を防止するための設備

大飯発電所3 / 4号炉	泊発電所3号炉	相違理由
<p>3章除熱評価式の試験による検証                      3.1 除熱評価式について                      (1) 除熱量評価の基礎式</p> <div style="border: 2px solid black; height: 600px; width: 100%;"></div>	<p>3章 除熱評価式の試験による検証                      3.1 除熱評価式について                      (1) 除熱量評価の基礎式</p> <div style="border: 2px solid black; height: 600px; width: 100%;"></div>	<p>記載表現の相違                      ・除熱評価の基礎式にて示す左辺・右辺の関係と同じ構文として記載した（伊方と同様）</p>
<p style="border: 1px solid black; padding: 2px;">枠囲みの範囲は機密に係る事項ですので公開することはできません。</p>	<p style="border: 1px solid black; padding: 2px;">枠囲みの内容は機密情報に属しますので公開できません。</p>	



赤字：設備、運用又は体制の相違（設計方針の相違）  
 青字：記載箇所又は記載内容の相違（記載方針の相違）  
 緑字：記載表現、設備名称の相違（実質的な相違なし）

第50条 原子炉格納容器の過圧破損を防止するための設備

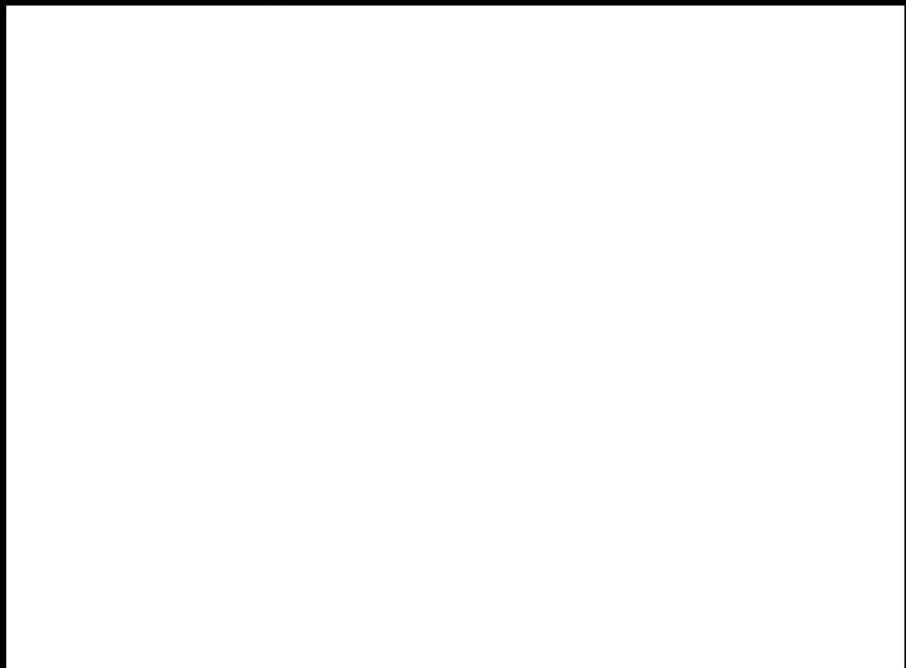
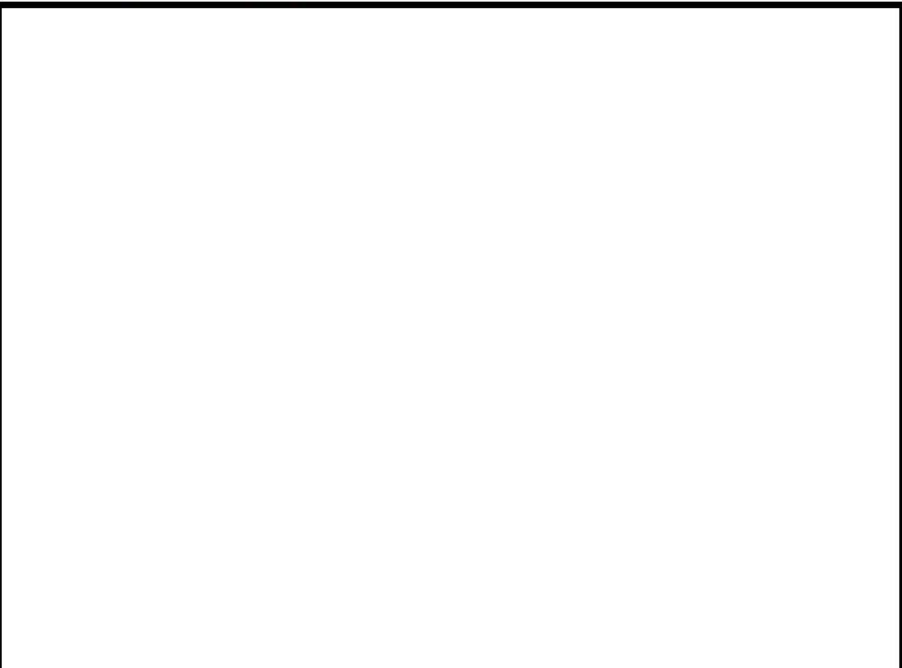
大飯発電所3/4号炉	泊発電所3号炉	相違理由
<p>(2) 除熱基礎式を用いた除熱評価</p> 	<p>(2) 除熱基礎式を用いた除熱評価</p> 	
<p>図3.1-1 格納容器再循環ユニットの除熱量評価モデル</p> <div style="border: 1px solid black; padding: 2px; width: fit-content; margin: 10px auto;"> <p>枠囲みの範囲は機密に係る事項ですので公開することはできません。</p> </div>	<p>図3.1-1 格納容器再循環ユニットの除熱量評価モデル</p> <div style="border: 1px solid black; padding: 2px; width: fit-content; margin: 10px auto;"> <p>枠囲みの内容は機密情報に属しますので公開できません。</p> </div>	

赤字：設備、運用又は体制の相違（設計方針の相違）  
 青字：記載箇所又は記載内容の相違（記載方針の相違）  
 緑字：記載表現、設備名称の相違（実質的な相違なし）

第50条 原子炉格納容器の過圧破損を防止するための設備

大飯発電所3/4号炉	泊発電所3号炉	相違理由
<p>3.2 除熱評価式の試験での検証</p> <p>2章での確認試験結果と除熱評価式との比較を行う。</p> <p>冷却水流量を定格の13m<sup>3</sup>/hの他、低流量の6m<sup>3</sup>/h、3m<sup>3</sup>/hとした場合において、各圧力での混合ガス流速に対する</p> <ul style="list-style-type: none"> <li>・冷却コイル熱交換量</li> <li>・水蒸気凝縮量</li> </ul> <p>の比較を行ったものをそれぞれ図3.2-1～3.2-6に示す。</p> <p>図3.2-1 混合ガス流速に対する冷却コイル熱交換量（冷却水流量：13m<sup>3</sup>/h）</p> <p>図3.2-2 混合ガス流速に対する水蒸気凝縮量（冷却水流量：13m<sup>3</sup>/h）</p>	<p>3.2 除熱評価式の試験での検証</p> <p>2章での確認試験結果と除熱評価式との比較を行う。</p> <p>冷却水流量を定格の13m<sup>3</sup>/hの他、低流量の6m<sup>3</sup>/h、3m<sup>3</sup>/hとした場合において、各圧力での混合ガス流速に対する</p> <ul style="list-style-type: none"> <li>・冷却コイル熱交換量</li> <li>・水蒸気凝縮量</li> </ul> <p>の比較を行ったものをそれぞれ図3.2-1～<b>図</b>3.2-6に示す。</p> <p>図3.2-1 混合ガス流速に対する冷却コイル熱交換量（冷却水流量：13m<sup>3</sup>/h）</p> <p>図3.2-2 混合ガス流速に対する水蒸気凝縮量（冷却水流量：13m<sup>3</sup>/h）</p>	

赤字：設備、運用又は体制の相違（設計方針の相違）  
 青字：記載箇所又は記載内容の相違（記載方針の相違）  
 緑字：記載表現、設備名称の相違（実質的な相違なし）

第50条 原子炉格納容器の過圧破損を防止するための設備

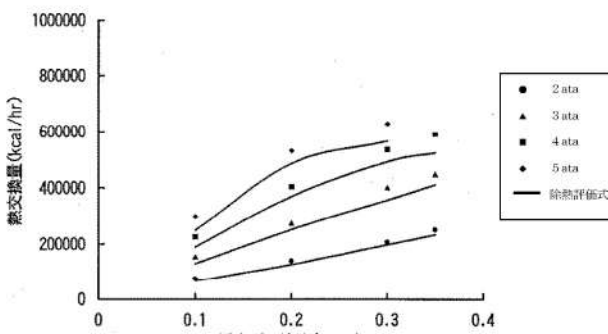
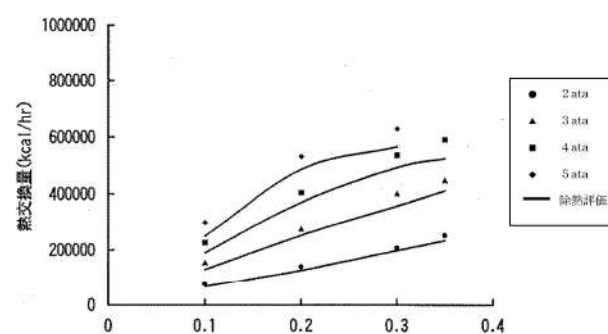
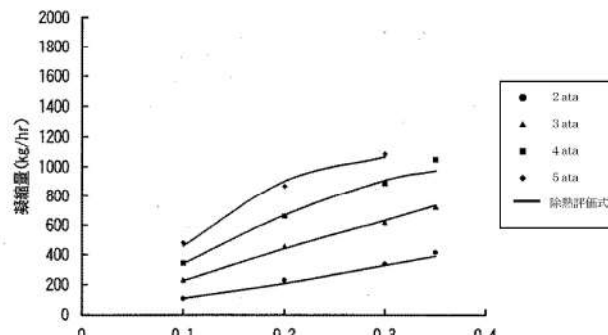
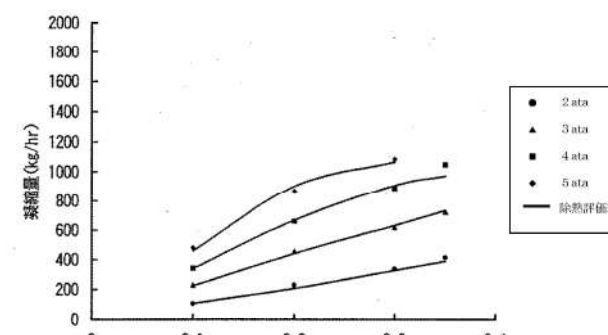
大飯発電所3/4号炉	泊発電所3号炉	相違理由
 <p>図3. 2-3 混合ガス流速に対する冷却コイル熱交換量 (冷却水流量: 6 m<sup>3</sup>/h)</p>	 <p>図3. 2-3 混合ガス流速に対する冷却コイル熱交換量 (冷却水流量: 6 m<sup>3</sup>/h)</p>	
 <p>図3. 2-4 混合ガス流速に対する水蒸気凝縮量 (冷却水流量: 6 m<sup>3</sup>/h)</p>	 <p>図3. 2-4 混合ガス流速に対する水蒸気凝縮量 (冷却水流量: 6 m<sup>3</sup>/h)</p>	



赤字：設備、運用又は体制の相違（設計方針の相違）  
 青字：記載箇所又は記載内容の相違（記載方針の相違）  
 緑字：記載表現、設備名称の相違（実質的な相違なし）

第50条 原子炉格納容器の過圧破損を防止するための設備

大飯発電所3/4号炉	泊発電所3号炉	相違理由
<p>図3. 2-5 混合ガス流速に対する冷却コイル熱交換量（冷却水流量：3 m<sup>3</sup>/h）</p>	<p>図3. 2-5 混合ガス流速に対する冷却コイル熱交換量（冷却水流量：3 m<sup>3</sup>/h）</p>	
<p>図3. 2-6 混合ガス流速に対する水蒸気凝縮量（冷却水流量：3 m<sup>3</sup>/h）</p>	<p>図3. 2-6 混合ガス流速に対する水蒸気凝縮量（冷却水流量：3 m<sup>3</sup>/h）</p>	
<p>それぞれの図中に実線で表されているものが除熱評価式に基づく計算結果である。                  これより、冷却コイル熱交換量、水蒸気凝縮量については試験結果と約1割程度の誤差範囲内で良く一致している。なお、除熱評価式は、実機条件（約5.0～9.0ata, 11.75m<sup>3</sup>/h）においては実験データに対して1割程度は保守側（余裕がある）となると考えられる。</p>	<p>それぞれの図中に実線で表されているものが除熱評価式に基づく計算結果である。                  これより、冷却コイル熱交換量、水蒸気凝縮量については試験結果と約1割程度の誤差範囲内で良く一致している。なお、除熱評価式は、実機条件（約3.9～6.9ata, 10.3m<sup>3</sup>/h）においては実験データに対して1割程度は保守側（余裕がある）となると考えられる。</p>	

赤字：設備、運用又は体制の相違（設計方針の相違）  
 青字：記載箇所又は記載内容の相違（記載方針の相違）  
 緑字：記載表現、設備名称の相違（実質的な相違なし）

第50条 原子炉格納容器の過圧破損を防止するための設備

大飯発電所3 / 4号炉	泊発電所3号炉	相違理由
<p>4章 自然対流冷却時の除熱性能評価</p> <p>格納容器再循環ユニットを用いた自然対流冷却は、冷却コイルにより凝縮・冷却され密度を増した混合ガス（空気及び水蒸気）と、格納容器内雰囲気混合ガスとの密度差及び高低差から得られるドラフト力と系全体の圧力損失によりバランスする自然対流によって、格納容器内の除熱を行うものである。</p> <p>格納容器再循環ユニットにおける自然対流冷却形成の概念は次のとおりである。</p> <p>（図4-1参照）</p> <p>（1）冷却水通水初期状態（図4-1 a）</p> <p>最初に、冷却水コイルへの冷却水通水による水蒸気凝縮によって、ユニット内側と外側の双方からコイルへ向かう流れが発生する（図中①）。次に、冷却によって密度を増すために下降流となり、コイル下部からユニット内外へ流れ出る（図中②）。その後、冷却空気の一部はコイル下部に滞留する（図中③）。</p> <p>（2）過渡状態（図4-1 b）</p> <p>過渡状態に移ると、ユニット内側は、ユニット外側の格納容器側空間よりも狭隘なことから、凝縮及び冷却が相対的に早く促進されるようになる（図中④領域）。このため、ユニット内側からのコイルへの流れが外側からの流れに比べて相対的に弱くなる（図中③）。また、ユニット内雰囲気の密度が増し、下部ダクトへの下降流が発生する（図中④）。</p> <p>（3）定常状態（図4-1 c）</p> <p>過渡状態の後に、ユニット内側の凝縮・冷却が更に促進すると、ユニット内雰囲気の密度が更に増し（図中⑤領域）、下降流が加速する。このために、ユニット外側⇒冷却コイル⇒ユニット内側⇒下部ダクト⇒吹出口（ダクト開放機構）⇒格納容器雰囲気の流れが形成され、自然対流冷却が定常状態となる（図中⑤）。</p>  <p>a. 冷却水通水初期状態      b. 過渡状態      c. 定常状態</p> <p>図4-1 格納容器再循環ユニット自然対流冷却形成の概念図</p> <p>枠囲みの範囲は機密に係る事項ですので公開することはできません。</p>	<p>4章 自然対流冷却時の除熱性能評価</p> <p>格納容器再循環ユニットを用いた自然対流冷却は、冷却コイルにより凝縮・冷却され密度を増した混合ガス（空気及び水蒸気）と、格納容器内雰囲気混合ガスとの密度差及び高低差から得られるドラフト力と系全体の圧力損失によりバランスする自然対流によって、格納容器内の除熱を行うものである。</p> <p>格納容器再循環ユニットにおける自然対流冷却形成の概念は次のとおりである。</p> <p>（図4-1参照）</p> <p>（1）冷却水通水初期状態（図4-1 a）</p> <p>最初に、冷却水コイルへの冷却水通水による水蒸気凝縮によって、ユニット内側と外側の双方からコイルへ向かう流れが発生する（図中①）。次に、冷却によって密度を増すために下降流となり、コイル下部からユニット内外へ流れ出る（図中②）。その後、冷却空気の一部はコイル下部に滞留する（図中③）。</p> <p>（2）過渡状態（図4-1 b）</p> <p>過渡状態に移ると、ユニット内側は、ユニット外側の格納容器側空間よりも狭隘なことから、凝縮及び冷却が相対的に早く促進されるようになる（図中④領域）。このため、ユニット内側からのコイルへの流れが外側からの流れに比べて相対的に弱くなる（図中③）。また、ユニット内雰囲気の密度が増し、下部ダクトへの下降流が発生する（図中④）。</p> <p>（3）定常状態（図4-1 c）</p> <p>過渡状態の後に、ユニット内側の凝縮・冷却が更に促進すると、ユニット内雰囲気の密度が更に増し（図中⑤領域）、下降流が加速する。このために、ユニット外側⇒冷却コイル⇒ユニット内側⇒下部ダクト⇒吹出口（ダクト開放機構）⇒格納容器雰囲気の流れが形成され、自然対流冷却が定常状態となる（図中⑤）。</p>  <p>a. 冷却水通水初期状態      b. 過渡状態      c. 定常状態</p> <p>図4-1 格納容器再循環ユニット自然対流冷却形成の概念図</p> <p>枠囲みの内容は機密情報に属しますので公開できません。</p>	



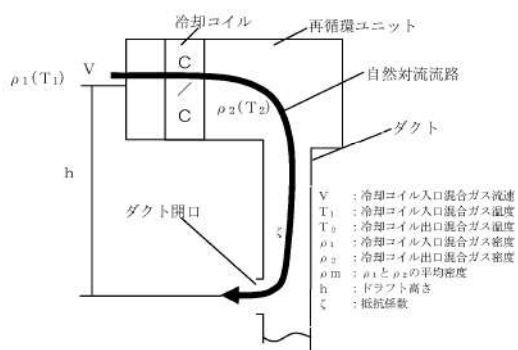
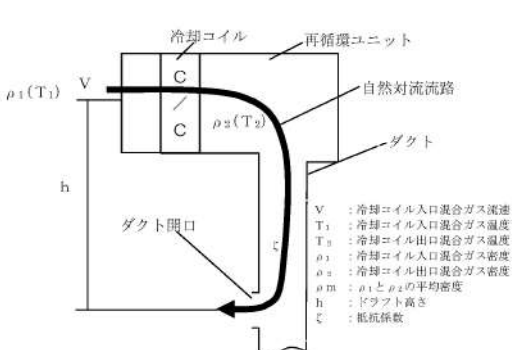

赤字：設備、運用又は体制の相違（設計方針の相違）  
 青字：記載箇所又は記載内容の相違（記載方針の相違）  
 緑字：記載表現、設備名称の相違（実質的な相違なし）

第50条 原子炉格納容器の過圧破損を防止するための設備

大飯発電所3/4号炉	泊発電所3号炉	相違理由
<p>自然対流冷却による除熱量については、冷却コイル性能試験で得られた知見を踏まえ、以下のように求める。</p>  <p>図4-2 再循環ユニットにおける自然対流モデル</p> <p>4. 1 ドラフト力計算について                  ドラフト力 (Pd) については、以下の式で求められる。  <math display="block">Pd = h \times (\rho_2 - \rho_1)</math>                 ここで、                  h : ドラフト高さ (再循環ユニット入口開口部中心～ダクト開口部中心までの高さ)</p> <p>4. 2 系統圧力損失計算について                  大飯3、4号機における自然対流冷却時の圧力損失を考慮するものとして、格納容器再循環ユニットの冷却コイル、ダクト (含むファン) があり、系統圧力損失 (ΔP) は以下より求められる。  <math display="block">\Delta P = \Delta P_c + \Delta P_p</math>                 ここで、                  ΔP<sub>c</sub> : 冷却コイル圧力損失                  ΔP<sub>p</sub> : ダクト圧力損失</p>	<p>自然対流冷却による除熱量については、冷却コイル性能試験で得られた知見を踏まえ、以下のように求める。</p>  <p>図4-2 再循環ユニットにおける自然対流モデル</p> <p>4. 1 ドラフト力計算について                  ドラフト力 (Pd) については、以下の式で求められる。  <math display="block">Pd = h \times (\rho_2 - \rho_1)</math>                 ここで、                  h : ドラフト高さ (再循環ユニット入口開口部中心～ダクト開口部中心までの高さ)</p> <p>4. 2 系統圧力損失計算について                  泊3号炉における自然対流冷却時の圧力損失を考慮するものとして、格納容器再循環ユニットの冷却コイル、ダクト (含むファン) があり、系統圧力損失 (ΔP) は以下より求められる。  <math display="block">\Delta P = \Delta P_c + \Delta P_p</math>                 ここで、                  ΔP<sub>c</sub> : 冷却コイル圧力損失                  ΔP<sub>p</sub> : ダクト圧力損失</p>	

赤字：設備、運用又は体制の相違（設計方針の相違）  
 青字：記載箇所又は記載内容の相違（記載方針の相違）  
 緑字：記載表現、設備名称の相違（実質的な相違なし）

第50条 原子炉格納容器の過圧破損を防止するための設備

大飯発電所3 / 4号炉	泊発電所3号炉	相違理由
<p>(1) 冷却コイル圧力損失</p> 	<p>(1) 冷却コイル圧力損失</p> 	
 <p>図4. 2-1 冷却コイル入口混合ガス流速に対する冷却コイル抵抗係数</p> <p>枠囲みの範囲は機密に係る事項ですので公開することはできません。</p>	 <p>図4. 2-1 冷却コイル入口混合ガス流速に対する冷却コイル抵抗係数</p> <p>枠囲みの内容は機密情報に属しますので公開できません。</p>	<p>設計の相違</p> <ul style="list-style-type: none"> <li>・格納容器再循環</li> <li>ネットの熱交換器コイルの設計の相違（7ページに示す表2-2の条件差異）</li> </ul>

赤字：設備、運用又は体制の相違（設計方針の相違）  
 青字：記載箇所又は記載内容の相違（記載方針の相違）  
 緑字：記載表現、設備名称の相違（実質的な相違なし）

第50条 原子炉格納容器の過圧破損を防止するための設備

大飯発電所3/4号炉	泊発電所3号炉	相違理由
<div data-bbox="286 304 943 1123" style="border: 2px solid black; height: 513px; width: 293px; margin: 0 auto;"></div> <div data-bbox="324 1129 866 1157" style="text-align: center;"> <p>図4.2-2 冷却コイル入口混合ガス流速に対する冷却コイルの前後差圧</p> </div> <div data-bbox="459 1273 911 1305" style="border: 1px solid black; padding: 2px; margin: 20px auto; width: fit-content;"> <p>枠囲みの範囲は機密に係る事項ですので公開することはできません。</p> </div>	<div data-bbox="1189 296 1845 1123" style="border: 2px solid black; height: 518px; width: 293px; margin: 0 auto;"></div> <div data-bbox="1234 1129 1776 1157" style="text-align: center;"> <p>図4.2-2 冷却コイル入口混合ガス流速に対する冷却コイルの前後差圧</p> </div> <div data-bbox="1323 1318 1767 1342" style="border: 1px solid black; padding: 2px; margin: 20px auto; width: fit-content;"> <p>枠囲みの内容は機密情報に属しますので公開できません。</p> </div>	



赤字：設備、運用又は体制の相違（設計方針の相違）  
 青字：記載箇所又は記載内容の相違（記載方針の相違）  
 緑字：記載表現、設備名称の相違（実質的な相違なし）

第50条 原子炉格納容器の過圧破損を防止するための設備

大飯発電所3/4号炉

泊発電所3号炉

相違理由

(2) ダクトの圧力損失

(2) ダクトの圧力損失

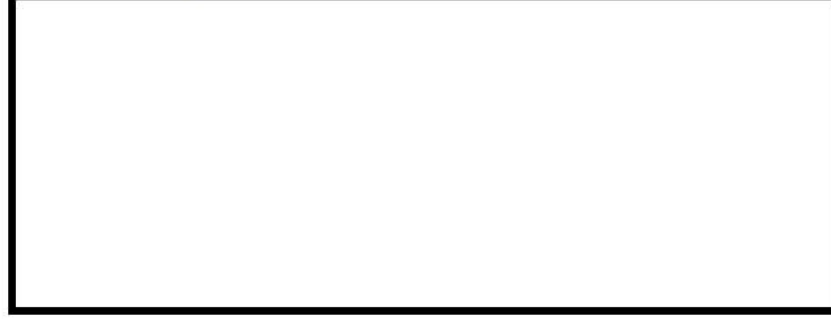

める。

4. 3 冷却コイル部の凝縮水等の影響考慮について

4. 3 冷却コイル部の凝縮水等の影響考慮について

図4. 3-1に冷却コイル性能試験時の冷却コイル高さ方向における冷却コイル出入口での冷却水温度をもとに算出した熱交換量の分布を示す。

図4. 3-1に冷却コイル性能試験時の冷却コイル高さ方向における冷却コイル出入口での冷却水温度をもとに算出した熱交換量の分布を示す。



図4. 3-1 冷却コイル高さ方向の除熱分布

図4. 3-1 冷却コイル高さ方向の除熱分布

この図より、冷却コイル下部にはほとんど伝熱に寄与していない領域があることが確認できる。また、この領域は冷却コイル入口混合ガス流速が減少するほど拡大し、有効な伝熱領域が縮小する傾向にあることがわかる。

この図より、冷却コイル下部にはほとんど伝熱に寄与していない領域があることが確認できる。また、この領域は冷却コイル入口混合ガス流速が減少するほど拡大し、有効な伝熱領域が縮小する傾向にあることがわかる。

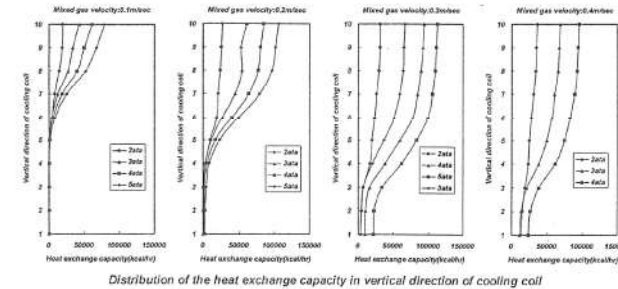
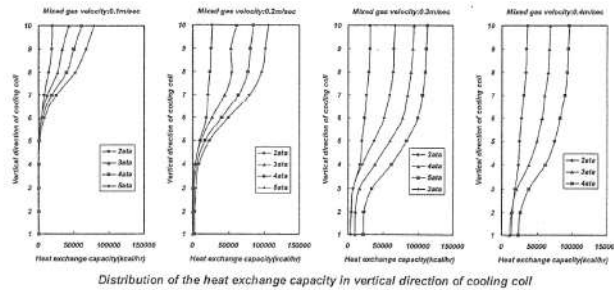
この原因としては、<①凝縮水>、<②冷却空気の滞留>の2点の影響が考えられる。

この原因としては、<①凝縮水>、<②冷却空気の滞留>の2点の影響が考えられる。

<①凝縮水の影響>

<①凝縮水の影響>

冷却コイル部では混合ガス中の水蒸気が凝縮し、コイルフィンを上部から下部に流下する。その結果、冷却コイル下部での凝縮水膜厚が上部より増し、コイルフィン間のガス流路が減少し、混合ガスの流入が妨げられると考えられる。また、凝縮膜厚の増加により、この部分での熱抵抗が増加し伝熱性能が低下すると考えられる。図4. 3-2に冷却コイルの外観（チューブとフィンの拡大）を示す。

冷却コイル部では混合ガス中の水蒸気が凝縮し、コイルフィンを上部から下部に流下する。その結果、冷却コイル下部での凝縮水膜厚が上部より増し、コイルフィン間のガス流路が減少し、混合ガスの流入が妨げられると考えられる。また、凝縮膜厚の増加により、この部分での熱抵抗が増加し伝熱性能が低下すると考えられる。図4. 3-2に冷却コイルの外観（チューブとフィンの拡大）を示す。

枠囲みの範囲は機密に係る事項ですので公開することはできません。

枠囲みの内容は機密情報に属しますので公開できません。

赤字：設備、運用又は体制の相違（設計方針の相違）  
 青字：記載箇所又は記載内容の相違（記載方針の相違）  
 緑字：記載表現、設備名称の相違（実質的な相違なし）

第50条 原子炉格納容器の過圧破損を防止するための設備

大飯発電所3/4号炉	泊発電所3号炉	相違理由
<div data-bbox="347 178 853 544" data-label="Image"> </div> <div data-bbox="371 547 806 569" data-label="Caption"> <p>図4.3-2 冷却コイルの外観（チューブとフィン拡大）</p> </div> <div data-bbox="201 612 468 639" data-label="Section-Header"> <p>&lt;②冷却空気の滞留の影響&gt;</p> </div> <div data-bbox="199 644 1043 775" data-label="Text"> <p>冷却コイルに進入した混合ガスが凝縮・冷却されることで、減速し、密度量を増すため、冷却コイル上部から下部への下降流が生じる。この一部が冷却コイルの下部に滞留し、より凝縮・冷却されることで冷却空気層を形成し、冷却コイル下部での混合ガスの流入が妨げられると考えられる。</p> </div> <div data-bbox="199 815 1043 912" data-label="Text"> <p>なお、冷却コイル性能試験においては、冷却コイル出口内流況を確認しており、図4.3-3に示すように、混合ガスが下向きの速度成分を持ちコイル内を斜め下方にコイル出口へ流出しており、冷却コイル下部においては、冷却空気の滞留も見られる。</p> </div> <div data-bbox="353 963 869 992" data-label="Text"> <p>枠囲みの範囲は機密に係る事項ですので公開することはできません。</p> </div>	<div data-bbox="1281 197 1787 563" data-label="Image"> </div> <div data-bbox="1305 564 1742 587" data-label="Caption"> <p>図4.3-2 冷却コイルの外観（チューブとフィン拡大）</p> </div> <div data-bbox="1088 612 1352 639" data-label="Section-Header"> <p>&lt;②冷却空気の滞留の影響&gt;</p> </div> <div data-bbox="1108 644 1966 775" data-label="Text"> <p>冷却コイルに進入した混合ガスが凝縮・冷却されることで、減速し、密度量を増すため、冷却コイル上部から下部への下降流が生じる。この一部が冷却コイルの下部に滞留し、より凝縮・冷却されることで冷却空気層を形成し、冷却コイル下部での混合ガスの流入が妨げられると考えられる。</p> </div> <div data-bbox="1108 815 1966 912" data-label="Text"> <p>なお、冷却コイル性能試験においては、冷却コイル出口内流況を確認しており、図4.3-3に示すように、混合ガスが下向きの速度成分を持ちコイル内を斜め下方にコイル出口へ流出しており、冷却コイル下部においては、冷却空気の滞留も見られる。</p> </div> <div data-bbox="1397 1002 1845 1024" data-label="Text"> <p>枠囲みの内容は機密情報に属しますので公開できません。</p> </div>	

赤字：設備、運用又は体制の相違（設計方針の相違）  
 青字：記載箇所又は記載内容の相違（記載方針の相違）  
 緑字：記載表現、設備名称の相違（実質的な相違なし）

第50条 原子炉格納容器の過圧破損を防止するための設備

大飯発電所3/4号炉	泊発電所3号炉	相違理由
<div data-bbox="224 327 940 1244" style="border: 2px solid black; width: 320px; height: 575px; margin: 0 auto;"></div> <div data-bbox="940 670 974 989" style="writing-mode: vertical-rl; text-orientation: upright; margin-left: 10px;">                     図4.3-3 冷却コイル出口ダクト内流況                 </div> <div data-bbox="459 1268 913 1305" style="border: 1px solid black; padding: 2px; margin-top: 10px;">                     枠囲みの範囲は機密に係る事項ですので公開することはできません。                 </div>	<div data-bbox="1131 319 1848 1236" style="border: 2px solid black; width: 320px; height: 575px; margin: 0 auto;"></div> <div data-bbox="1848 670 1881 989" style="writing-mode: vertical-rl; text-orientation: upright; margin-left: 10px;">                     図4.3-3 冷却コイル出口ダクト内流況                 </div> <div data-bbox="1317 1316 1765 1340" style="border: 1px solid black; padding: 2px; margin-top: 10px;">                     枠囲みの内容は機密情報に属しますので公開できません。                 </div>	



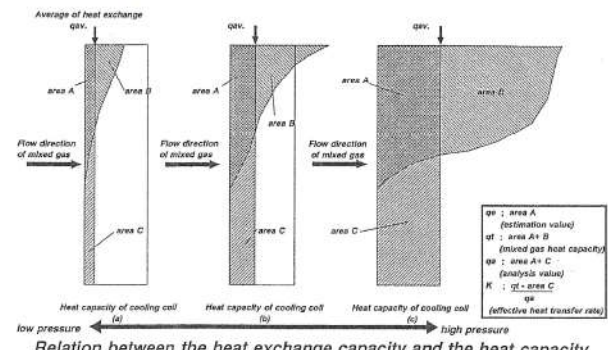
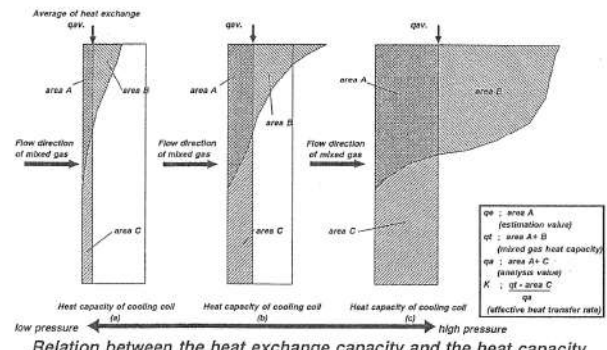

赤字：設備、運用又は体制の相違（設計方針の相違）  
 青字：記載箇所又は記載内容の相違（記載方針の相違）  
 緑字：記載表現、設備名称の相違（実質的な相違なし）

第50条 原子炉格納容器の過圧破損を防止するための設備

大飯発電所3/4号炉	泊発電所3号炉	相違理由
<p>このように冷却コイル性能試験では、冷却コイル下部の閉塞状況が測定されている。一方、冷却コイルトータル除熱量は、平均流速で評価した評価式での除熱量とよく一致する結果となった（図3.2-1参照）。</p> <p>このことから、以下の考察を実施した。</p>  <p>図4.3-4 冷却コイルの除熱量と熱容量の関係</p> <p>図4.3-4に冷却コイルの除熱量と熱容量の関係を示す。ここで、縦軸は冷却コイル高さを、横軸は各高さにおける除熱量を、長方形の枠は冷却コイルの熱容量を表したものである。</p> <p>冷却コイル性能試験では、冷却コイル下部での閉塞により、冷却コイル高さ方向での流速分布が発生したが、冷却コイルのトータル除熱量（<math>qt</math>=領域A+領域B）は、平均流速で評価した場合（閉塞が無い状態でコイル内を平均流速で流れた場合の）の除熱量（<math>qa</math>=領域A+領域C）とよく一致する結果となった（<math>qt \approx qa</math>）。これは、流入する混合ガスの保有熱量に対して、冷却コイルの熱容量に余裕があったために、冷却コイル下部での除熱量低下分（領域C）が、冷却コイル上部（領域B）で補完される結果となったためであると考えられる（図4.3-4（a）の状態）。</p> <p>これに対して、冷却コイル性能試験よりも高温高圧の条件を想定した場合（図4.3-4（c）の状態）には、流入する混合ガスの保有熱量が増加するために、冷却コイルの熱容量の余裕が減少し、ある温度圧力以上になると冷却コイル上部での除熱が頭打ちになり（領域Bが寄与しない。領域B=0）、冷却コイル下部での除熱量の低下分（領域C）の補完ができなくなる可能性がある（<math>qt</math>-領域C（領域B）=領域A）ことが考えられる。</p> <p>そこで、各圧力での混合ガス流速に対し、冷却コイル全伝熱面と伝熱に寄与しない部分を除く有効な伝熱面との比率（有効伝熱率）を求め、除熱量評価において用いる。</p> <p>有効伝熱率の評価においては、この条件で最も保守的と考えられる図4.3-4の（c）の状態を考慮している。具体的には、有効伝熱率（K）は、下式で示される。</p> $K = (qt - \text{領域C}) / qa$	<p>このように冷却コイル性能試験では、冷却コイル下部の閉塞状況が測定されている。一方、冷却コイルトータル除熱量は、平均流速で評価した評価式での除熱量とよく一致する結果となった（図3.2-1参照）。</p> <p>このことから、以下の考察を実施した。</p>  <p>図4.3-4 冷却コイルの除熱量と熱容量の関係</p> <p>図4.3-4に冷却コイルの除熱量と熱容量の関係を示す。ここで、縦軸は冷却コイル高さを、横軸は各高さにおける除熱量を、長方形の枠は冷却コイルの熱容量を表したものである。</p> <p>冷却コイル性能試験では、冷却コイル下部での閉塞により、冷却コイル高さ方向での流速分布が発生したが、冷却コイルのトータル除熱量（<math>qt</math>=領域A+領域B）は、平均流速で評価した場合（閉塞が無い状態でコイル内を平均流速で流れた場合の）の除熱量（<math>qa</math>=領域A+領域C）とよく一致する結果となった（<math>qt \approx qa</math>）。これは、流入する混合ガスの保有熱量に対して、冷却コイルの熱容量に余裕があったために、冷却コイル下部での除熱量低下分（領域C）が、冷却コイル上部（領域B）で補完される結果となったためであると考えられる（図4.3-4（a）の状態）。</p> <p>これに対して、冷却コイル性能試験よりも高温高圧の条件を想定した場合（図4.3-4（c）の状態）には、流入する混合ガスの保有熱量が増加するために、冷却コイルの熱容量の余裕が減少し、ある温度圧力以上になると冷却コイル上部での除熱が頭打ちになり（領域Bが寄与しない。領域B=0）、冷却コイル下部での除熱量の低下分（領域C）の補完ができなくなる可能性がある（<math>qt</math>-領域C（領域B）=領域A）ことが考えられる。</p> <p>そこで、各圧力での混合ガス流速に対し、冷却コイル全伝熱面と伝熱に寄与しない部分を除く有効な伝熱面との比率（有効伝熱率）を求め、除熱量評価において用いる。</p> <p>有効伝熱率の評価においては、この条件で最も保守的と考えられる図4.3-4の（c）の状態を考慮している。具体的には、有効伝熱率（K）は、下式で示される。</p> $K = (qt - \text{領域C}) / qa$	

赤字：設備、運用又は体制の相違（設計方針の相違）  
 青字：記載箇所又は記載内容の相違（記載方針の相違）  
 緑字：記載表現、設備名称の相違（実質的な相違なし）

第50条 原子炉格納容器の過圧破損を防止するための設備

大飯発電所3/4号炉	泊発電所3号炉	相違理由
<p>ここで分子の“qt-領域C”は冷却コイルの下部無効領域を差し引いた有効伝熱領域（有効除熱量）で領域Aを示し、分母の qa は冷却コイルの全伝熱領域（全除熱量）で領域A+Cを示す。また、冷却コイル性能試験においては <math>qa \approx qt</math> なので実際の評価では下式にて評価している。</p> $K = \text{領域A} / (\text{領域A} + \text{領域B})$   <p>図4. 3-5 領域Aの求め方</p> <p>枠囲みの範囲は機密に係る事項ですので公開することはできません。</p>	<p>ここで分子の“qt-領域C”は冷却コイルの下部無効領域を差し引いた有効伝熱領域（有効除熱量）で領域Aを示し、分母の qa は冷却コイルの全伝熱領域（全除熱量）で領域A+Cを示す。また、冷却コイル性能試験においては <math>qa \approx qt</math> なので実際の評価では下式にて評価している。</p> $K = \text{領域A} / (\text{領域A} + \text{領域B})$   <p>図4. 3-5 領域Aの求め方</p> <p>枠囲みの内容は機密情報に属しますので公開できません。</p>	

赤字：設備、運用又は体制の相違（設計方針の相違）  
 青字：記載箇所又は記載内容の相違（記載方針の相違）  
 緑字：記載表現、設備名称の相違（実質的な相違なし）

第50条 原子炉格納容器の過圧破損を防止するための設備

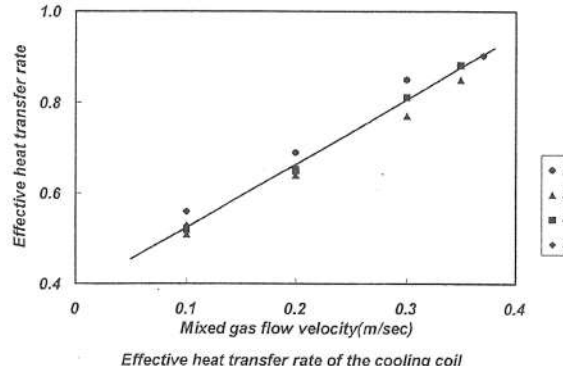
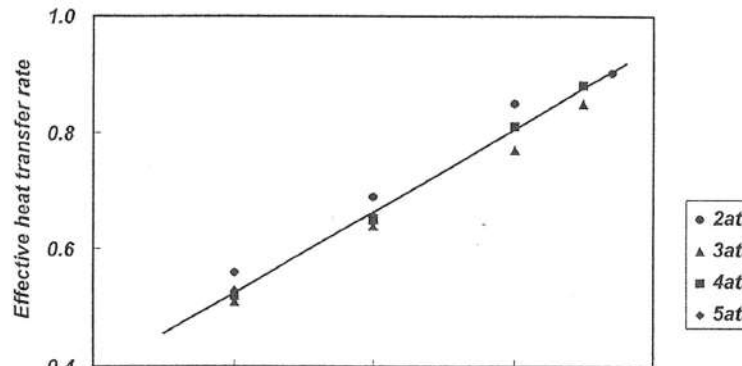
大飯発電所3 / 4号炉	泊発電所3号炉	相違理由
<p>このようにして求めた有効伝熱率は図4. 3-6の通りであり、流速の増加とともに有効伝熱率は増加する傾向にある。有効伝熱率に影響を及ぼす&lt;①凝縮水&gt;、&lt;②冷却空気の滞留&gt;の2つの要因のうち、&lt;②冷却空気の滞留&gt;の方が有効伝熱率に対して支配的な要因と考えられる。これは、一般的に&lt;①凝縮水&gt;については流速の増加に伴い増加するが、冷却コイル性能試験の結果では、流速が増加しても伝熱性能が低下する方向とならなかったためである。</p>  <p>図4. 3-6 冷却コイルの有効伝熱率</p> <p>上記の結果は、2章「格納容器再循環ユニット冷却コイル性能試験概要（PWR5電力共研概要）」において、実機を模擬した単体（1段積み）の冷却コイルによる性能試験の結果を基に評価したものである。一方、実機は上下方向に設置された複数の冷却コイル（大飯3、4号機は添付資料0 図1-2に示す通り3段積み）で形成されている。有効伝熱率に対して支配的な要因である冷却空気の滞留に関しては、上下方向に積み重ねた方が滞留域から離れた冷却コイルの範囲が広くなるとともに、ドラフト力が増加するために冷却コイル出口の流速が増し、有効伝熱率の評価に用いた冷却コイル入口の流速も速くなる。したがって、コイル全体としては冷却空気の滞留の影響を受けにくくなるため、性能試験結果を適用することは妥当である。</p>	<p>このようにして求めた有効伝熱率は図4. 3-6の通りであり、流速の増加とともに有効伝熱率は増加する傾向にある。有効伝熱率に影響を及ぼす&lt;①凝縮水&gt;、&lt;②冷却空気の滞留&gt;の2つの要因のうち、&lt;②冷却空気の滞留&gt;の方が有効伝熱率に対して支配的な要因と考えられる。これは、一般的に&lt;①凝縮水&gt;については流速の増加に伴い増加するが、冷却コイル性能試験の結果では、流速が増加しても伝熱性能が低下する方向とならなかったためである。</p>  <p>図4. 3-6 冷却コイルの有効伝熱率</p> <p>上記の結果は、2章「格納容器再循環ユニット冷却コイル性能試験概要（PWR5電力共研概要）」において、実機を模擬した単体（1段積み）の冷却コイルによる性能試験の結果を基に評価したものである。一方、実機は上下方向に設置された複数の冷却コイル（泊3号炉は参考資料0 図1-2に示す通り2段積み）で形成されている。有効伝熱率に対して支配的な要因である冷却空気の滞留に関しては、上下方向に積み重ねた方が滞留域から離れた冷却コイルの範囲が広くなるとともに、ドラフト力が増加するために冷却コイル出口の流速が増し、有効伝熱率の評価に用いた冷却コイル入口の流速も速くなる。したがって、コイル全体としては冷却空気の滞留の影響を受けにくくなるため、性能試験結果を適用することは妥当である。</p>	<p>記載表現の相違</p> <p>設計の相違</p> <p>・格納容器再循環ユニットの熱交換器コイルの設計の相違。</p> <p>但し、記載のとおり試験体が1段に対し、複数段設置のため試験結果の適用が妥当であることに相違なし。</p>

赤字：設備、運用又は体制の相違（設計方針の相違）  
 青字：記載箇所又は記載内容の相違（記載方針の相違）  
 緑字：記載表現、設備名称の相違（実質的な相違なし）

第50条 原子炉格納容器の過圧破損を防止するための設備

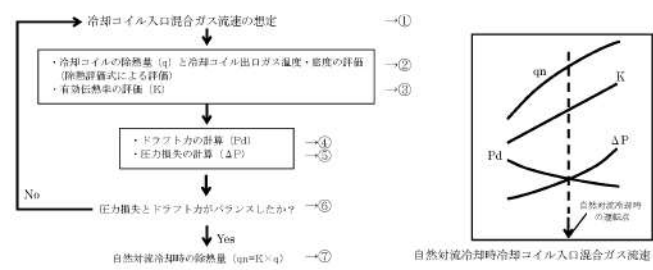
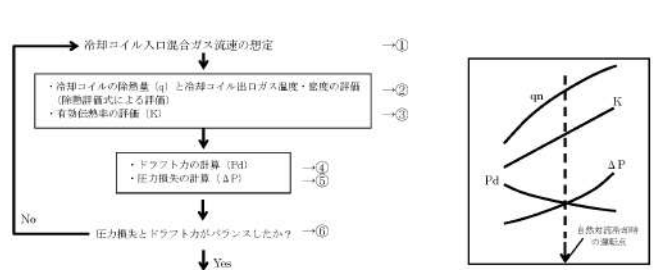
大飯発電所3/4号炉	泊発電所3号炉	相違理由
<p>4.4 自然対流冷却の除熱量評価手順について</p> <p>自然対流冷却時の除熱量は、ドラフト高さから引き起こされるドラフト力と系全体の圧力損失がバランスする冷却コイル入口混合ガス流速から求める。</p> <p>実際の除熱においては4.3で示したように冷却コイル下部は閉塞が見られ除熱に寄与しない箇所があるため、有効伝熱率（K）を用いて、以下のように自然対流冷却時の除熱性能を評価している。</p>  <p>図4.4-1 自然対流冷却の除熱量評価フロー</p> <p>ここで、</p> <ol style="list-style-type: none"> <li>①冷却コイル入口混合ガス流速Vを想定する。</li> <li>②除熱評価式により、上記流速Vと格納容器雰囲気条件を想定した場合の除熱量qと冷却コイル出口ガス温度・密度を求める</li> <li>③VからK値を求める（4.3参照）。</li> <li>④ドラフト力Pdを求める（4.1参照）。</li> </ol> <div style="border: 1px solid black; height: 40px; width: 100%;"></div> <div style="border: 1px solid black; padding: 5px; width: fit-content; margin: 10px auto;">                 枠囲みの範囲は機密に係る事項ですので公開することはできません。             </div> <p style="text-align: center;">48-8-24</p>	<p>4.4 自然対流冷却の除熱量評価手順について</p> <p>自然対流冷却時の除熱量は、ドラフト高さから引き起こされるドラフト力と系全体の圧力損失がバランスする冷却コイル入口混合ガス流速から求める。</p> <p>実際の除熱においては4.3で示したように冷却コイル下部は閉塞が見られ除熱に寄与しない箇所があるため、有効伝熱率（K）を用いて、以下のように自然対流冷却時の除熱性能を評価している。</p>  <p>図4.4-1 自然対流冷却の除熱量評価フロー</p> <p>ここで、</p> <ol style="list-style-type: none"> <li>①冷却コイル入口混合ガス流速Vを想定する。</li> <li>②除熱評価式により、上記流速Vと格納容器雰囲気条件を想定した場合の除熱量qと冷却コイル出口ガス温度・密度を求める</li> <li>③VからK値を求める（4.3参照）。</li> <li>④ドラフト力Pdを求める（4.1参照）。</li> </ol> <div style="border: 1px solid black; height: 40px; width: 100%;"></div> <div style="border: 1px solid black; padding: 5px; width: fit-content; margin: 10px auto;">                 枠囲みの内容は機密情報に属しますので公開できません。             </div>	

赤字：設備、運用又は体制の相違（設計方針の相違）  
 青字：記載箇所又は記載内容の相違（記載方針の相違）  
 緑字：記載表現、設備名称の相違（実質的な相違なし）

第50条 原子炉格納容器の過圧破損を防止するための設備

大飯発電所3/4号炉	泊発電所3号炉	相違理由
<div data-bbox="255 178 936 593" style="border: 2px solid black; width: 100%; height: 100%;"></div> <p data-bbox="383 609 777 632">図4. 4-2 ドラフト高さと混合ガス流速について</p> <p data-bbox="183 646 1039 678">⑤圧力損失<math>\Delta P = \Delta P_c + \Delta P_p</math>を求める（4. 2参照）。その際、冷却コイル <span style="border: 1px solid black; display: inline-block; width: 100px; height: 15px;"></span></p> <p data-bbox="197 678 779 710"><span style="border: 1px solid black; display: inline-block; width: 100%; height: 15px;"></span></p> <p data-bbox="183 715 1039 774">⑥④と⑤で求めたドラフト力と圧力損失がバランスしていなければ、①に戻りユニット入口ガス流速Vを見直す。</p> <p data-bbox="183 782 1039 841">⑦バランスしたユニット入口ガス流速Vと除熱評価式から求めた除熱量qにKを掛け自然対流冷却時の除熱量q<sub>n</sub>を求める。</p> <p data-bbox="163 884 1039 943">上記の手順で格納容器内圧（格納容器内温度）を変化させて求めたq<sub>n</sub>が添付資料0図1-1の重大事故時の再循環ユニットの除熱性能曲線となる。</p> <div data-bbox="450 975 900 1007" style="border: 1px solid black; padding: 2px; width: fit-content; margin: 10px auto;">枠囲みの範囲は機密に係る事項ですので公開することはできません。</div> <p data-bbox="920 1098 987 1120" style="text-align: center;">48-8-25</p>	<div data-bbox="1205 178 1863 577" style="border: 2px solid black; width: 100%; height: 100%;"></div> <p data-bbox="1332 593 1704 616">図4. 4-2 ドラフト高さと混合ガス流速について</p> <p data-bbox="1099 646 1951 678">⑤圧力損失<math>\Delta P = \Delta P_c + \Delta P_p</math>を求める（4. 2参照）。<span style="border: 1px solid black; display: inline-block; width: 100%; height: 15px;"></span></p> <p data-bbox="1113 678 1682 710"><span style="border: 1px solid black; display: inline-block; width: 100%; height: 15px;"></span></p> <p data-bbox="1099 715 1955 774">⑥④と⑤で求めたドラフト力と圧力損失がバランスしていなければ、①に戻りユニット入口ガス流速Vを見直す。</p> <p data-bbox="1099 782 1955 841">⑦バランスしたユニット入口ガス流速Vと除熱評価式から求めた除熱量qにKを掛け自然対流冷却時の除熱量q<sub>n</sub>を求める。</p> <p data-bbox="1079 884 1955 943">上記の手順で格納容器内圧（格納容器内温度）を変化させて求めたq<sub>n</sub>が参考資料0図1-1の重大事故時の再循環ユニットの除熱性能曲線となる。</p> <div data-bbox="1317 1002 1935 1034" style="border: 1px solid black; padding: 2px; width: fit-content; margin: 10px auto;"><span style="border: 1px solid black; display: inline-block; width: 20px; height: 15px;"></span> 枠囲みの内容は機密情報に属しますので公開できません。</div>	<p data-bbox="1973 884 2101 906" style="color: green;">記載表現の相違</p>



赤字：設備、運用又は体制の相違（設計方針の相違）  
 青字：記載箇所又は記載内容の相違（記載方針の相違）  
 緑字：記載表現、設備名称の相違（実質的な相違なし）

第50条 原子炉格納容器の過圧破損を防止するための設備

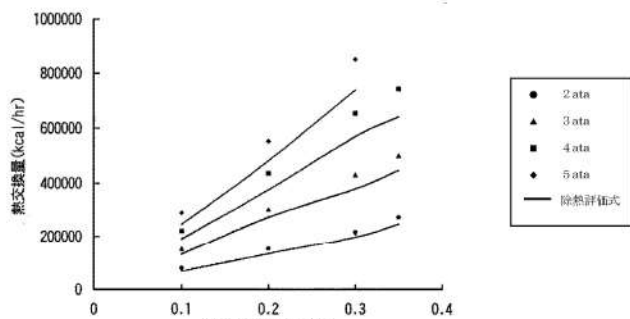
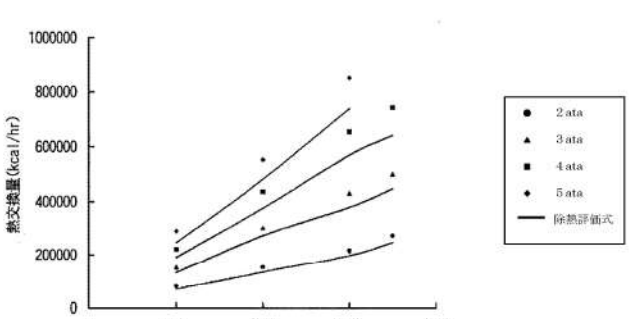
大飯発電所3/4号炉	泊発電所3号炉	相違理由
<p>5章 除熱量計算手法の妥当性に関する考察</p> <p>5.1 不凝縮性ガスの除熱性能に対する影響について</p> <p>(1) 不凝縮性ガスの影響について</p> <p>格納容器再循環ユニットの除熱性能は不凝縮性ガスの影響（除熱性能、コイル下部の影響）を含む評価を実施している。</p> <p>冷却コイル性能試験では、実機格納容器雰囲気条件を模擬した不凝縮性ガスを含む条件にて、不凝縮性ガスの影響を含む冷却コイルの除熱性能、冷却コイル下部の影響を把握している。</p> <p>冷却コイルの除熱性能について、試験結果と評価結果がよく一致しており（図5.1-1）、実機冷却除熱性能は試験により検証された除熱評価式を用いて評価している。</p>  <p>図5.1-1 混合ガス流速対除熱量（図3.2-1の再掲）</p> <p>また、最終的な自然対流冷却除熱性能評価では、上記冷却コイルの除熱性能に対してコイル下部の影響を考慮した評価を実施している。</p> <p>試験では、実機と同タイプ、同サイズの冷却コイルを用いているため、凝縮面の形状、液膜の除去能力も実機と同等の影響を把握できているものと考えている。</p> <p>(2) 生成される水素の影響について</p> <p>原子炉格納容器内に水素が存在する場合に、格納容器再循環ユニットの除熱性能は水素濃度に応じて変化するため、格納容器破損防止の観点で、ドライ換算で13vol%の水素が原子炉格納容器内に存在する場合の感度解析を実施し、原子炉格納容器圧力及び温度に対する影響を確認した。</p> <p>ドライ換算で13vol%の水素が原子炉格納容器内に存在する場合、原子炉格納容器圧力は格納容器再循環ユニットによる格納容器内自然対流冷却開始前に最高値に到達するため、最高値に関して格納容器内自然対流冷却の水素濃度の影響はない。その後の格納容器内自然対流冷却開始後においては、水素濃度の影響を考慮しても、格納容器内自然対流冷却により原子炉格納容器圧力は低下傾向となっており、原子炉格納容器最高使用圧力の2倍(0.78MPa[gage])に対して十分余裕がある。また、原子炉格納容器雰囲気温度への影響は小さく、原子炉格納容器雰囲気温度200℃に対して十分</p>	<p>5章 除熱量計算手法の妥当性に関する考察</p> <p>5.1 不凝縮性ガスの除熱性能に対する影響について</p> <p>(1) 不凝縮性ガスの影響について</p> <p>格納容器再循環ユニットの除熱性能は不凝縮性ガスの影響（除熱性能、コイル下部の影響）を含む評価を実施している。</p> <p>冷却コイル性能試験では、実機格納容器雰囲気条件を模擬した不凝縮性ガスを含む条件にて、不凝縮性ガスの影響を含む冷却コイルの除熱性能、冷却コイル下部の影響を把握している。</p> <p>冷却コイルの除熱性能について、試験結果と評価結果がよく一致しており（図5.1-1）、実機冷却除熱性能は試験により検証された除熱評価式を用いて評価している。</p>  <p>図5.1-1 混合ガス流速対除熱量（図3.2-1の再掲）</p> <p>また、最終的な自然対流冷却除熱性能評価では、上記冷却コイルの除熱性能に対してコイル下部の影響を考慮した評価を実施している。</p> <p>試験では、実機と同タイプ、同サイズの冷却コイルを用いているため、凝縮面の形状、液膜の除去能力も実機と同等の影響を把握できているものと考えている。</p> <p>(2) 生成される水素の影響について</p> <p>原子炉格納容器内に水素が存在する場合に、格納容器再循環ユニットの除熱性能は水素濃度に応じて変化するため、格納容器破損防止の観点で、ドライ換算で13vol%の水素が原子炉格納容器内に存在する場合の感度解析を実施し、原子炉格納容器圧力及び温度に対する影響を確認した。</p> <p>ドライ換算で13vol%の水素が原子炉格納容器内に存在する場合、原子炉格納容器圧力を約0.01MPaの範囲で高めに評価し、原子炉格納容器雰囲気温度は1℃未満の上昇幅である。評価項目である原子炉格納容器圧力及び温度は、それぞれ原子炉格納容器の最高使用圧力の2倍及び200℃に対して十分余裕があり、水素濃度による不確かさを考慮しても、評価項目となるパラメータに与える影響は小さいことを確認した。（参考資料-6）</p>	<p>解析結果の相違                  ・相違理由は、参考資料6にて記載する。</p> <p>記載表現の相違                  ・相違理由は、参考資料6にて記載する。</p>

赤字：設備、運用又は体制の相違（設計方針の相違）  
 青字：記載箇所又は記載内容の相違（記載方針の相違）  
 緑字：記載表現、設備名称の相違（実質的な相違なし）

第50条 原子炉格納容器の過圧破損を防止するための設備

大飯発電所3/4号炉

余裕があるため、水素濃度による不確かさを考慮しても、評価項目となるパラメータに与える影響は小さいことを確認した。（参考資料-6）

5. 2 冷却コイル性能試験範囲の妥当性について

表2-2に示すように、大飯3、4号機における再循環ユニットの使用温度条件に対し、冷却コイル性能試験の実施範囲は少し低いものとなっていることについての考察を以下に述べる。

冷却コイル性能試験では、凝縮熱伝達項を含む除熱評価式で算出された除熱量、凝縮量と実験で測定された実験値を比較し、除熱評価式の妥当性を確認している。

図5. 2-1に示すとおり凝縮量について、実験値は評価値とよく一致している。



図5. 2-1 実験による検証試験データと凝縮量評価との比較  
 (図3. 2-2の横軸を変更したもの)

一方、全除熱量については、凝縮熱伝達量（水蒸気凝縮による潜熱除去）と対流熱伝達量（温度降下による顕熱除去）によって達成され、保守的に評価される（図5. 2-2参照）。

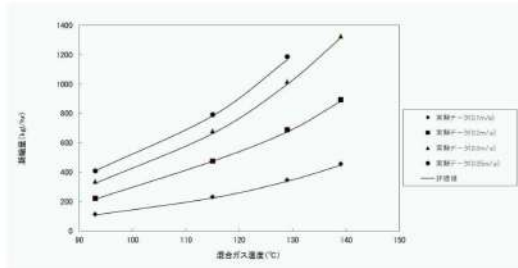

図5. 2-2 実験による検証試験データと除熱評価との比較  
 (図3. 2-1の横軸を変更したもの)

泊発電所3号炉

相違理由

5. 2 冷却コイル性能試験範囲の妥当性について

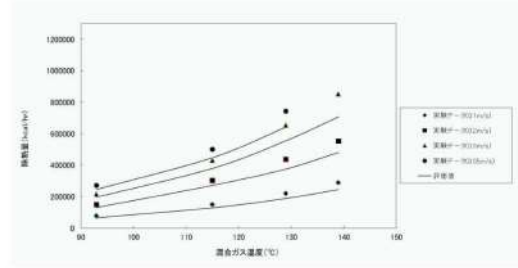
表2-2に示すように、泊3号炉における再循環ユニットの使用温度条件に対し、冷却コイル性能試験の実施範囲は少し低いものとなっていることについての考察を以下に述べる。

冷却コイル性能試験では、凝縮熱伝達項を含む除熱評価式で算出された除熱量、凝縮量と実験で測定された実験値を比較し、除熱評価式の妥当性を確認している。

図5. 2-1に示すとおり凝縮量について、実験値は評価値とよく一致している。



図5. 2-1 実験による検証試験データと凝縮量評価との比較  
 (図3. 2-2の横軸を変更したもの)

一方、全除熱量については、凝縮熱伝達量（水蒸気凝縮による潜熱除去）と対流熱伝達量（温度降下による顕熱除去）によって達成され、保守的に評価される（図5. 2-2参照）。

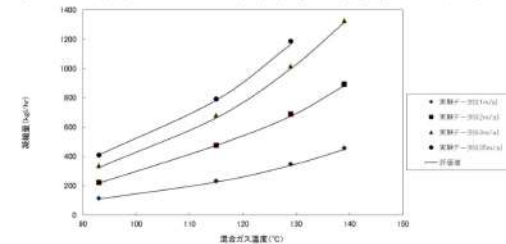

図5. 2-2 実験による検証試験データと除熱評価との比較  
 (図3. 2-1の横軸を変更したもの)

設備名称の相違

赤字：設備、運用又は体制の相違（設計方針の相違）  
 青字：記載箇所又は記載内容の相違（記載方針の相違）  
 緑字：記載表現、設備名称の相違（実質的な相違なし）

第50条 原子炉格納容器の過圧破損を防止するための設備

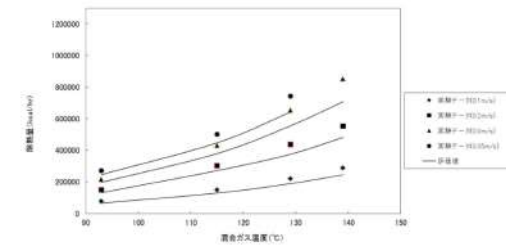
大飯発電所3/4号炉	泊発電所3号炉	相違理由
<p>凝縮熱量の全除熱量に占める割合は実験値では約80～85%、評価値では約90～95%となり、評価値が大きくなる理由としては、凝縮熱伝達量が実験値と評価値でよく一致していることから、対流熱伝達量が保守的に評価されていると考える。その理由として、混合ガスの熱伝達係数と温度低下量（凝縮液膜の温度）が保守的に評価されているため、対流熱伝達量は保守的な評価となっているが、この保守性は温度に依存しない。</p> <p>以上から凝縮熱伝達については実験値と評価値でよく一致しており、全熱量についても対流熱伝達の保守性により、保守的に評価されるが、その保守性は温度に依存しないことから、除熱評価式は実験値から有効であるといえるため、冷却コイル性能試験の範囲を超える範囲での評価も可能である。</p> <p>なお、これらの除熱評価式、冷却コイル性能試験は共に飽和蒸気条件を前提としており、有効性評価で自然対流冷却を期待しているいずれのシーケンスでも、蒸気条件は飽和状態となっている。</p>	<p>凝縮熱量の全除熱量に占める割合は実験値では約80～85%、評価値では約90～95%となり、評価値が大きくなる理由としては、凝縮熱伝達量が実験値と評価値でよく一致していることから、対流熱伝達量が保守的に評価されていると考える。その理由として、混合ガスの熱伝達係数と温度低下量（凝縮液膜の温度）が保守的に評価されているため、対流熱伝達量は保守的な評価となっているが、この保守性は温度に依存しない。</p> <p>以上から凝縮熱伝達については実験値と評価値でよく一致しており、全熱量についても対流熱伝達の保守性により、保守的に評価されるが、その保守性は温度に依存しないことから、除熱評価式は実験値から有効であるといえるため、冷却コイル性能試験の範囲を超える範囲での評価も可能である。</p> <p>なお、これらの除熱評価式、冷却コイル性能試験は共に飽和蒸気条件を前提としており、有効性評価で自然対流冷却を期待しているいずれのシーケンスでも、蒸気条件は飽和状態となっている。</p>	



赤字：設備、運用又は体制の相違（設計方針の相違）  
 青字：記載箇所又は記載内容の相違（記載方針の相違）  
 緑字：記載表現、設備名称の相違（実質的な相違なし）

第50条 原子炉格納容器の過圧破損を防止するための設備

大飯発電所3/4号炉	泊発電所3号炉	相違理由
<p>6章 まとめ</p> <p>重大事故時における格納容器再循環ユニットによる自然対流冷却の除熱性能を評価するにあたり、以下の事項を実施した。</p> <ul style="list-style-type: none"> <li>・実機サイズの格納容器再循環ユニット冷却コイルを模擬した試験装置において、重大事故時の格納容器雰囲気条件を模擬した試験を行い、冷却コイルにおける除熱評価式の検証を実施した。</li> <li>・冷却コイル性能試験において凝縮水や冷却空気の滞留による冷却コイル下部での閉塞（除熱の低下）が確認されたものの、冷却コイルでの熱容量余裕からコイル上部での除熱量が増加し、総除熱量については低下が見られない状況が確認された。そこで、冷却コイル性能試験よりも高温高圧の条件で冷却コイルの熱容量余裕がなくなることを保守的に想定し、除熱評価式を使った再循環ユニットの除熱性能評価においては、閉塞する冷却コイル下部分の除熱は期待しないものとして、評価を実施した。</li> <li>・系統圧力損失として、冷却コイル部については、冷却コイル性能試験において測定した出入口差圧に基づき抵抗係数を求めた。</li> </ul> <p>上記を踏まえ、重大事故時の格納容器再循環ユニットによる自然対流冷却時の除熱性能曲線を求めた。</p>	<p>6章 まとめ</p> <p>重大事故時における格納容器再循環ユニットによる自然対流冷却の除熱性能を評価するにあたり、以下の事項を実施した。</p> <ul style="list-style-type: none"> <li>・実機サイズの格納容器再循環ユニット冷却コイルを模擬した試験装置において、重大事故時の格納容器雰囲気条件を模擬した試験を行い、冷却コイルにおける除熱評価式の検証を実施した。</li> <li>・冷却コイル性能試験において凝縮水や冷却空気の滞留による冷却コイル下部での閉塞（除熱の低下）が確認されたものの、冷却コイルでの熱容量余裕からコイル上部での除熱量が増加し、総除熱量については低下が見られない状況が確認された。そこで、冷却コイル性能試験よりも高温高圧の条件で冷却コイルの熱容量余裕がなくなることを保守的に想定し、除熱評価式を使った再循環ユニットの除熱性能評価においては、閉塞する冷却コイル下部分の除熱は期待しないものとして、評価を実施した。</li> <li>・系統圧力損失として、冷却コイル部については、冷却コイル性能試験において測定した出入口差圧に基づき抵抗係数を求めた。</li> </ul> <p>上記を踏まえ、重大事故時の格納容器再循環ユニットによる自然対流冷却時の除熱性能曲線を求めた。</p>	

赤字：設備、運用又は体制の相違（設計方針の相違）  
 青字：記載箇所又は記載内容の相違（記載方針の相違）  
 緑字：記載表現、設備名称の相違（実質的な相違なし）

第50条 原子炉格納容器の過圧破損を防止するための設備

大飯発電所3/4号炉	泊発電所3号炉	相違理由
<p>参考資料-0 格納容器再循環ユニットの実機条件</p> <p>1. 格納容器再循環ユニットの実機条件</p> <p>格納容器再循環ユニットは、通常運転時において、冷却コイルに原子炉補機冷却水を通水し、格納容器再循環ファンによる強制循環によって、格納容器内の機器、配管等からの発熱を除去するために設置している。</p> <p>また、重大事故時には、格納容器再循環ファンによる強制循環に期待せずとも、冷却コイルに原子炉補機冷却水又は海水を通水することで格納容器内の水蒸気を凝縮させ、自然対流による循環によって冷却し、格納容器圧力上昇を抑制できる。</p> <p>以下に、格納容器再循環ユニットの実機条件を示す。</p> <p>1. 1 実機の機器仕様・構造</p> <p>(1) 機器仕様</p> <p>格納容器再循環ユニットは、4個設置されており、通常運転時は3個、重大事故時は2個使用する。</p> <p>種類：冷却コイル</p> <p>容量（注1）：約0.74MW/個（通常運転時）</p> <p>約12.3MW/個（格納容器最高使用圧力時の値（約144℃））</p> <p>約13.0MW/個（格納容器最高使用圧力の2倍時の値（約168℃））</p> <p>（注1）冷却水温度35℃、冷却水流量 <input type="text"/> m<sup>3</sup>/h における値。</p>  <p>図1-1 重大事故時の格納容器再循環ユニットの除熱性能曲線</p> <p><input type="text"/> 枠囲みの範囲は機密に係る事項ですので公開できません。</p>	<p>参考資料-0 格納容器再循環ユニットの実機条件</p> <p>1. 格納容器再循環ユニットの実機条件</p> <p>格納容器再循環ユニットは、通常運転時において、冷却コイルに原子炉補機冷却水を通水し、格納容器再循環ファンによる強制循環によって、格納容器内の機器、配管等からの発熱を除去するために設置している。</p> <p>また、重大事故時には、格納容器再循環ファンによる強制循環に期待せずとも、冷却コイルに原子炉補機冷却水又は海水を通水することで格納容器内の水蒸気を凝縮させ、自然対流による循環によって冷却し、格納容器圧力上昇を抑制できる。</p> <p>以下に、格納容器再循環ユニットの実機条件を示す。</p> <p>1. 1 実機の機器仕様・構造</p> <p>(1) 機器仕様</p> <p>格納容器再循環ユニットは、4個設置されており、通常運転時は3個、重大事故時は2個使用する。</p> <p>種類：冷却コイル</p> <p>容量（注1）：約0.59MW/個（通常運転時）</p> <p>約6.7MW/個（格納容器最高使用圧力時の値（約132℃））</p> <p>約7.6MW/個（格納容器最高使用圧力の2倍時の値（約155℃））</p> <p>（注1）冷却水温度32℃、冷却水流量 <input type="text"/> m<sup>3</sup>/h における値</p>  <p>図1-1 重大事故時の格納容器再循環ユニットの除熱性能曲線</p> <p><input type="text"/> 枠囲みの内容は機密情報に属しますので公開できません。</p>	<p>設計の相違</p> <ul style="list-style-type: none"> <li>・格納容器再循環ユニットの設計相違</li> <li>・格納容器内雰囲気解析結果の相違</li> <li>・冷却水条件の相違</li> </ul>

赤字：設備、運用又は体制の相違（設計方針の相違）  
 青字：記載箇所又は記載内容の相違（記載方針の相違）  
 緑字：記載表現、設備名称の相違（実質的な相違なし）

第50条 原子炉格納容器の過圧破損を防止するための設備

大飯発電所3/4号炉	泊発電所3号炉	相違理由
<p>(2) 容量</p> <p>格納容器再循環ユニットの容量は、通常運転時における格納容器内の環境維持のための必要冷却能力を基に設定し、格納容器内を49℃以下に維持するために必要な容量としている。</p> <p>通常運転時における格納容器内の発熱量は約2.2MWであり、3個の格納容器再循環ユニットを使用するため、格納容器再循環ユニット1個あたりの容量は約0.74MW/個である。</p> <p>また、重大事故時は、冷却水を通水した冷却コイルで水蒸気が凝縮することにより、冷却コイル出入口で密度差が生じ、冷却コイル入口と下部ダクト出口の高低差によるドラフト力で自然対流が発生し、格納容器内の熱を除去する。自然対流による除熱能力は、格納容器内雰囲気温度・圧力、ドラフト高さによる風量及び冷却水温度等により決まり、格納容器内雰囲気温度約168℃において格納容器再循環ユニット1個あたり約13.0MWの除熱量が得られる。この格納容器再循環ユニットを2個使用することにより、格納容器圧力を最高使用圧力の2倍以下に抑えることができる。</p>	<p>(2) 容量</p> <p>格納容器再循環ユニットの容量は、通常運転時における格納容器内の環境維持のための必要冷却能力を基に設定し、格納容器内を49℃以下に維持するために必要な容量としている。</p> <p>通常運転時における格納容器内の発熱量は約1.77MWであり、3個の格納容器再循環ユニットを使用するため、格納容器再循環ユニット1個あたりの容量は約0.59MWである。</p> <p>また、重大事故時は、冷却水を通水した冷却コイルで水蒸気が凝縮することにより、冷却コイル出入口で密度差が生じ、冷却コイル入口と下部ダクト出口の高低差によるドラフト力で自然対流が発生し、格納容器内の熱を除去する。自然対流による除熱能力は、格納容器内雰囲気温度・圧力、ドラフト高さによる風量及び冷却水温度等により決まり、格納容器内雰囲気温度約155℃において格納容器再循環ユニット1個あたり約7.6MWの除熱量が得られる。この格納容器再循環ユニットを2個使用することにより、格納容器圧力を最高使用圧力の2倍以下に抑えることができる。</p>	<p>設計の相違</p> <ul style="list-style-type: none"> <li>・通常運転時において格納容器内へ放出される機器放熱等の相違</li> <li>・事故時の格納容器内条件及び再循環ユニット及び再循環ダクト構成の相違</li> </ul>

赤字：設備、運用又は体制の相違（設計方針の相違）  
 青字：記載箇所又は記載内容の相違（記載方針の相違）  
 緑字：記載表現、設備名称の相違（実質的な相違なし）

第50条 原子炉格納容器の過圧破損を防止するための設備

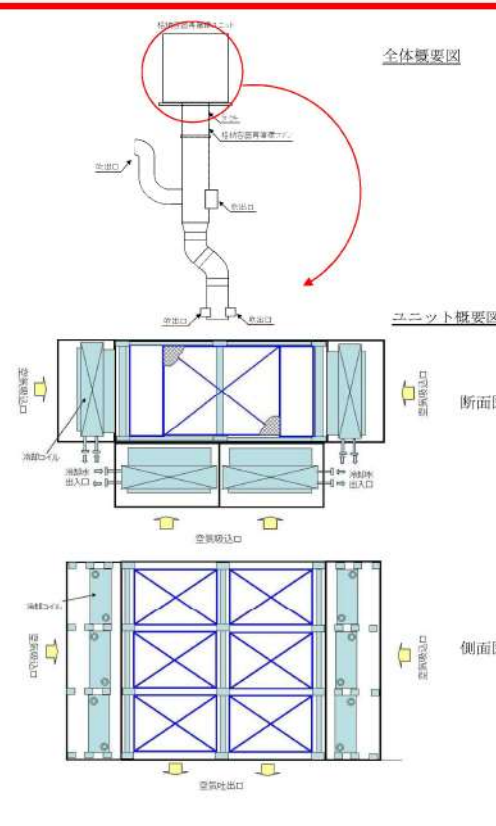
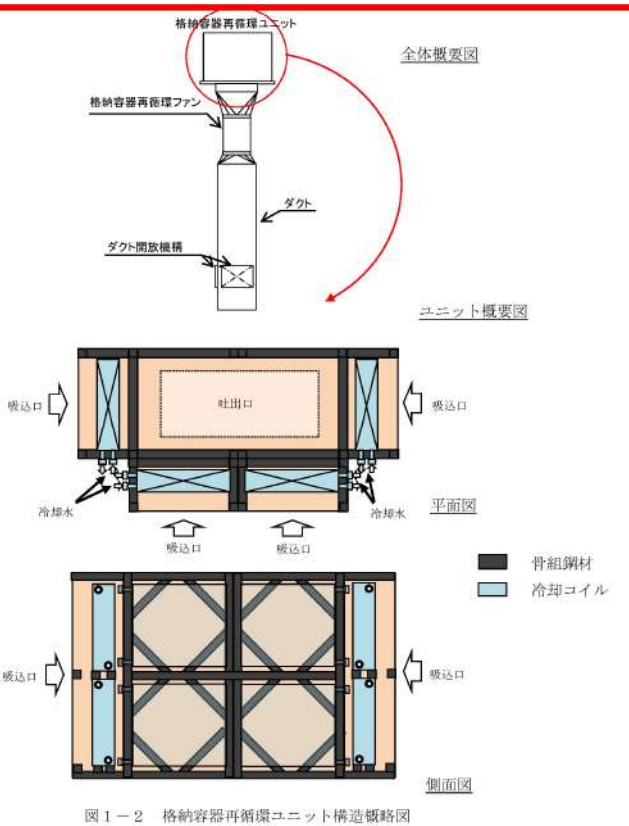
大飯発電所3/4号炉	泊発電所3号炉	相違理由
<p>(3) 格納容器再循環ユニットの構造</p> <p>格納容器再循環ユニットの流路上には、冷却コイル、ダクト、ファンが設置されており、自然対流の算出における圧力損失の評価では、流路上の全ての機器の抵抗を考慮し、これに基づく自然対流冷却の成立性を確認している。なお、<b>大飯3、4号機</b>の再循環ユニットは冷却コイル4面に<b>上下3段の計12個</b>のコイルが設置されている。図1-2に格納容器再循環ユニットの概要図を示す。</p>  <p>図1-2 格納容器再循環ユニット構造概略図</p>	<p>(3) 格納容器再循環ユニットの構造</p> <p>格納容器再循環ユニットの流路上には、冷却コイル、ダクト、ファンが設置されており、自然対流の算出における圧力損失の評価では、流路上の全ての機器の抵抗を考慮し、これに基づく自然対流冷却の成立性を確認している。なお、<b>泊3号炉</b>の再循環ユニットは冷却コイル4面に<b>上下2段の計8個</b>のコイルが設置されている。図1-2に格納容器再循環ユニットの概要図を示す。</p>  <p>図1-2 格納容器再循環ユニット構造概略図</p>	<p>設備名称の相違                  設計方針の相違                  ・再循環ユニット設計の相違</p>

赤字：設備、運用又は体制の相違（設計方針の相違）  
 青字：記載箇所又は記載内容の相違（記載方針の相違）  
 緑字：記載表現、設備名称の相違（実質的な相違なし）

第50条 原子炉格納容器の過圧破損を防止するための設備

大飯発電所3/4号炉	泊発電所3号炉	相違理由
<p>(4) 格納容器再循環ユニット冷却コイルの構造                      格納容器再循環ユニットの冷却コイルは、冷却フィンとコイルで構成されている。                      図1-3に冷却コイルの外観を示す。</p> <div data-bbox="309 279 884 694"> <p>冷却水ヘッダー部 (冷却水温度計測用熱伝対取付状態)</p> <p>チューブベント部</p> </div> <div data-bbox="465 734 728 1125"> </div> <p>図1-3 冷却コイルの外観（冷却コイル性能試験で使用のもの）</p>	<p>(4) 格納容器再循環ユニット冷却コイルの構造                      格納容器再循環ユニットの冷却コイルは、冷却フィンとコイルで構成されている。                      図1-3に冷却コイルの外観を示す。</p> <div data-bbox="1220 287 1792 694"> <p>冷却水ヘッダー部 (冷却水温度計測用熱伝対取付状態)</p> <p>チューブベント部</p> </div> <div data-bbox="1377 750 1635 1141"> </div> <p>図1-3 冷却コイルの外観（冷却コイル性能試験で使用のもの）</p>	



赤字：設備、運用又は体制の相違（設計方針の相違）  
 青字：記載箇所又は記載内容の相違（記載方針の相違）  
 緑字：記載表現、設備名称の相違（実質的な相違なし）

第50条 原子炉格納容器の過圧破損を防止するための設備

大飯発電所3 / 4号炉	泊発電所3号炉	相違理由
<p data-bbox="168 172 1041 263">大飯3、4号機の格納容器再循環ユニットでは、冷却コイルにハーフサーキット型が使用されており、これは、PWRプラントの格納容器再循環ユニット冷却コイルの型式では最も多く使用されている。</p> <p data-bbox="168 274 1041 367">図1-4にハーフサーキット型冷却コイルの側面及び鳥瞰図の概念図を示す。ハーフサーキット型冷却コイルでは、空気の流れに対して冷却水はまず下流から上流へ行き来して流れるので、ハーフサーキットでの分配本数はチューブ本数に対して半分となる。</p> <div data-bbox="206 391 976 901" style="border: 1px solid black; width: 100%; height: 100%;"></div> <p data-bbox="353 901 407 917">側面図</p> <p data-bbox="734 901 788 917">鳥瞰図</p> <p data-bbox="421 944 766 960">図1-4 ハーフサーキット型冷却コイル概念図</p> <div data-bbox="452 1141 900 1173" style="border: 1px solid black; padding: 2px; width: fit-content; margin: 20px auto;">                 枠囲みの範囲は機密に係る事項ですので公開することはできません。             </div>	<p data-bbox="1086 172 1951 263">泊3号炉の格納容器再循環ユニットでは、冷却コイルにハーフサーキット型が使用されており、これは、PWRプラントの格納容器再循環ユニット冷却コイルの型式では最も多く使用されている。</p> <p data-bbox="1086 274 1960 367">図1-4にハーフサーキット型冷却コイルの側面及び鳥瞰図の概念図を示す。ハーフサーキット型冷却コイルでは、空気の流れに対して冷却水はまず下流から上流へ行き来して流れるので、ハーフサーキットでの分配本数はチューブ本数に対して半分となる。</p> <div data-bbox="1122 391 1892 901" style="border: 1px solid black; width: 100%; height: 100%;"></div> <p data-bbox="1270 901 1323 917">側面図</p> <p data-bbox="1641 901 1695 917">鳥瞰図</p> <p data-bbox="1328 944 1673 960">図1-4 ハーフサーキット型冷却コイル概念図</p> <div data-bbox="1321 1173 1769 1197" style="border: 1px solid black; padding: 2px; width: fit-content; margin: 20px auto;">                 枠囲みの内容は機密情報に属しますので公開できません。             </div>	<p data-bbox="1975 172 2114 196">設備名称の相違</p>

赤字：設備、運用又は体制の相違（設計方針の相違）  
 青字：記載箇所又は記載内容の相違（記載方針の相違）  
 緑字：記載表現、設備名称の相違（実質的な相違なし）

第50条 原子炉格納容器の過圧破損を防止するための設備

大飯発電所3/4号炉	泊発電所3号炉	相違理由
<p>(5) ダクト開放機構</p> <p>伊方3号機の通常時の再循環ダクトの吹出口はダクト最下端部の1箇所に設置されており、重大事故等時には、吹出口のフェールクローズ (F.C) のダンパが閉止する。また、水没することが想定されることから、水没しないレベルにダクト開放口を設置し、開放口に開放機構を設置している。(図1-5、6、表1-1)</p> <p>a. ダクト開放機構動作原理</p> <p>格納容器内雰囲気温度が上昇し、ダクト開放機構駆動装置に取り付けられた温度ヒューズ(①)が溶断することにより、ダクト開放機構の操作ハンドルの回転を止めているヒューズ押しピン(②)が引き抜かれ、作動スプリング(③)により操作ハンドル(④)が回転しダクト開放機構が開放される。</p> <p>b. ダクト開放機構の開放設定温度</p> <p>格納容器再循環ユニットによる格納容器内自然対流冷却は、格納容器圧力が最高使用圧力(0.283MPa)に達した後に開始することを想定している。このため、ダクト開放機構の温度ヒューズの設定温度は、格納容器の最高使用圧力到達時点における蒸気分圧に対する飽和温度(約132℃)に対して十分な裕度を考慮し、110℃に設定している。</p> <p>なお、この温度設定より低い温度設定の温度ヒューズを採用した場合、早期に格納容器内自然対流冷却を開始することが可能となるが、格納容器再循環ユニットの除熱量は格納容器内雰囲気温度に依存し、格納容器内雰囲気温度が低い場合には除熱量も低くなることから、格納容器圧力及び温度の最高値への低減効果は小さいと考えられる。</p> <p>c. 冷却水早期通水の影響</p> <p>ダクト開放機構が動作する前に冷却水を通水する場合であっても、温度ヒューズはダクト開放機構の格納容器内雰囲気側に設置しているため、ダクト内の冷却による影響を直接受けずに格納容器内雰囲気温度によって温度ヒューズは溶断され、ダクト開放機構は作動する。</p> <div style="border: 1px solid black; padding: 5px; margin-top: 10px; width: fit-content; margin-left: auto; margin-right: auto;"> <p>本記載は、伊方3号炉の参考掲載</p> </div>	<p>(5) ダクト開放機構</p> <p>泊3号炉の通常時の再循環ダクトの吹出口はダクト最下端部の1箇所に設置されており、重大事故等時には、吹出口のフェールクローズ (F.C) のダンパが閉止する。また、水没することが想定されることから、水没しないレベルにダクト開放口を新たに設置し、開放口に開放機構を設置した。(図1-5、6、表1-1)</p> <p>a. ダクト開放機構動作原理</p> <p>格納容器内雰囲気温度が上昇し、ダクト開放機構駆動装置に取り付けられたメルティングヒューズ(①)が溶断することにより、ダクト開放機構の操作ハンドルの回転を止めているヒューズ押しピン(②)が引き抜かれ、作動スプリング(③)により操作ハンドル(④)が回転しダクト開放機構が開放される。</p> <p>b. ダクト開放機構の開放設定温度</p> <p>格納容器再循環ユニットによる格納容器内自然対流冷却は、格納容器圧力が最高使用圧力に達した後に開始することを想定している。このため、ダクト開放機構のメルティングヒューズの設定温度は、格納容器の最高使用圧力に対する飽和温度(約132℃)に対して十分な裕度を考慮し110℃に設定している。</p> <p>この温度設定より低い温度設定の標準品としては、72℃の温度設定のものがあるが、格納容器再循環系統の最高使用温度65℃を考慮するとダクト開放機構が誤作動した場合、格納容器下部への冷却空気が減少し、1次冷却材ポンプや原子炉容器などの冷却に悪影響を及ぼす懸念があるため採用しない。</p> <p>なお、この温度設定より低い温度設定の温度ヒューズを採用した場合、早期に格納容器内自然対流冷却を開始することが可能となるが、格納容器再循環ユニットの除熱量は格納容器内雰囲気温度に依存し、格納容器内雰囲気温度が低い場合には除熱量も低くなることから、格納容器圧力及び温度の最高値への低減効果は小さいと考えられる。</p> <p>c. 冷却水早期通水の影響</p> <p>ダクト開放機構が動作する前に冷却水を通水する場合であっても、温度ヒューズはダクト開放機構の格納容器内雰囲気側に設置しているため、ダクト内の冷却による影響を直接受けずに格納容器内雰囲気温度によって温度ヒューズは溶断され、ダクト開放機構は作動する。</p>	<p><b>設計の相違</b></p> <ul style="list-style-type: none"> <li>・PCCVである大飯3/4号炉は、CV内再循環が「外のメルティング」、CV内構造が、銅製CVの泊3号炉と異なり、大量のCV内注水を実施した場合でも、再循環が「外の末端が水没せず、再循環出口が開放した状態を維持できるため、ダクト開放機構を設置していない。</li> <li>・比較対象として、銅製CVの伊方3号炉のダクト開放機構にかかる記載と比較を行う。</li> </ul>

赤字：設備、運用又は体制の相違（設計方針の相違）  
 青字：記載箇所又は記載内容の相違（記載方針の相違）  
 緑字：記載表現、設備名称の相違（実質的な相違なし）

第50条 原子炉格納容器の過圧破損を防止するための設備

大飯発電所3/4号炉	泊発電所3号炉	相違理由
<p>図1-5 ダクト開放機構概略図</p> <p>本記載は、伊方3号炉の参考掲載</p>	<p>図1-5 ダクト開放機構概略図</p>	

赤字：設備、運用又は体制の相違（設計方針の相違）  
 青字：記載箇所又は記載内容の相違（記載方針の相違）  
 緑字：記載表現、設備名称の相違（実質的な相違なし）

第50条 原子炉格納容器の過圧破損を防止するための設備

大飯発電所3/4号炉	泊発電所3号炉	相違理由
<p>(6) ダクト開放機構の信頼性</p> <p>ダクト開放機構については、重大事故等時の環境下において、電源や空気源に頼ることなく、静的、且つ温度上昇に対して確実に開放できる仕組みとして温度ヒューズを使用したダクト開放機構を選定しており、開放機構の基本的な構造は防火ダンパと同様である。</p> <p>また、過去の研究※において自然対流冷却の流路確保に対するダクト開放機構の信頼性を確認することを目的として、下表のように温度ヒューズの単体特性試験及び作動性能実証試験を実施し、ダクト開放機構の作動性能を検証しており、高い信頼性があることを確認している。</p> <p>なお、伊方3号機の温度ヒューズ納入時にも、納入する温度ヒューズと同じロット番号の温度ヒューズを使用し、単体特性試験を実施した結果、設定温度110℃に対して、-4℃～-5℃の範囲にて溶断することを確認している。</p> <p>また、ダクト開放機構についても、電共研による作動性能実証試験において成果を得られた試験体と同仕様品を採用している。</p> <div data-bbox="179 635 981 1212" style="border: 1px solid black; height: 362px; width: 358px; margin: 10px 0;"></div> <div data-bbox="604 1268 963 1316" style="border: 1px solid black; padding: 2px; margin: 10px 0;">                     本記載は、伊方3号炉の参考掲載                 </div>	<p>(6) ダクト開放機構の信頼性</p> <p>ダクト開放機構については、重大事故時の環境下において、電源や空気源に頼ることなく、静的、且つ温度上昇に対して確実に開放できる仕組みとしてメルティングヒューズを使用したダクト開放機構を選定しており、開放機構の基本的な構造は防火ダンパと同様である。</p> <p>また、過去の研究※において自然対流冷却の流路確保に対するダクト開放機構の信頼性を確認することを目的として、下表のようにメルティングヒューズの単体特性試験及び作動性能実証試験を実施し、ダクト開放機構の作動性能を検証しており、高い信頼性があることを確認している。</p> <p>なお、泊発電所3号炉のメルティングヒューズ納入時にも、納入するメルティングヒューズと同じロット番号のメルティングヒューズを使用し、単体特性試験を実施した結果、設定温度110℃に対して、+0℃～-6℃の範囲にて溶断することを確認している。</p> <p>また、ダクト開放機構についても、電共研による作動性能実証試験において成果を得られた試験体と同仕様品を採用している。</p> <p>※「電力共同研究アクションマネジメント要素技術の実証に関する研究（平成6年度最終報告書）」</p> <div data-bbox="1064 730 1892 1109" style="border: 1px solid black; height: 237px; width: 370px; margin: 10px 0;"></div>	<p>設備名称の相違                      ・呼称は相違するが同一仕様品である。</p>

赤字：設備、運用又は体制の相違（設計方針の相違）  
 青字：記載箇所又は記載内容の相違（記載方針の相違）  
 緑字：記載表現、設備名称の相違（実質的な相違なし）

第50条 原子炉格納容器の過圧破損を防止するための設備

大飯発電所3/4号炉	泊発電所3号炉	相違理由
<div data-bbox="147 188 1046 580" data-label="Image"> </div> <div data-bbox="389 600 770 624" data-label="Caption"> <p>図1-7 温度ヒューズ単体特性試験装置</p> </div> <div data-bbox="147 667 949 1323" data-label="Image"> </div> <div data-bbox="322 1348 779 1372" data-label="Caption"> <p>図1-8 ダクト解放機構の作動性能実証試験装置</p> </div> <div data-bbox="629 1385 983 1417" data-label="Text"> <p>本記載は、伊方3号炉の参考掲載</p> </div>	<div data-bbox="1088 240 1912 555" data-label="Image"> </div> <div data-bbox="1279 568 1704 592" data-label="Caption"> <p>図1-7 メルティングヒューズ単体特性試験装置</p> </div> <div data-bbox="1088 635 1912 1286" data-label="Image"> </div> <div data-bbox="1263 1305 1688 1329" data-label="Caption"> <p>図1-8 ダクト開放機構の作動性能実証試験装置</p> </div>	

赤字：設備、運用又は体制の相違（設計方針の相違）  
 青字：記載箇所又は記載内容の相違（記載方針の相違）  
 緑字：記載表現、設備名称の相違（実質的な相違なし）

第50条 原子炉格納容器の過圧破損を防止するための設備

大飯発電所3/4号炉	泊発電所3号炉	相違理由
<p>(5) 実機配置</p> <p>大飯3、4号機では、重大事故時の自然対流路として、EL. 38.7mに設置の2台（A、D）の再循環ユニットの下部ダクトに設置される吹き出し口のうち、中間フロア（EL. 26mのフロアに設置）を評価対象としている（図1-5参照）。なお、大飯3、4号機には、ダクト開放機構は設置されていない。</p> <p>&lt;中間出口のみで評価する妥当性&gt;再循環ダクトには各フロアに対して3箇所の吹出口がある。このうち、最下層のフロアに設置する吹出口については再循環ユニットからの高さがあり最もドラフト効果が期待できるとともに、現状の有効性評価のシナリオで水没することはないが、評価では期待していない。</p> <p>また、最上部の吹出口からの流れについては、立ち上がっているダクト形状から評価上は加味せず、中間部の吹出口への流れのみとすることにより自然対流量を保守的に見積もり、除熱量に対しても保守的な評価としている。</p> <p>なお、格納容器再循環ユニットで冷却された格納容器内ガスは再循環ユニット内で密度が高くなりダクト内を下降していくことでドラフト力が発生するものであるが、自然対流が形成する過程で最上部の吹出口から流れが全て抜けてしまうことはなく、ドラフト力の発生を阻害するものではない（最上部と中間部の吹出口のダクトからの分岐高さは同じ高さである）。</p>	<p>(7) 実機配置</p> <p>泊3号炉では、重大事故時の自然対流路を確保するためにメルティングヒューズで開放するダクト開放機構をT.P. 38.8m設置の2台（C、D）の再循環ユニットの下部ダクトに設置しており、この開放機構（T.P. 17.8mフロアに設置）を評価対象としている。</p> <div data-bbox="1164 798 1836 1149" data-label="Diagram"> </div>	<p><u>設計の相違</u></p> <ul style="list-style-type: none"> <li>・POCVである大飯3/4号炉は、CV内再循環が「外のメーキング」、CV内構造が、銅製CVの泊3号炉と異なり、大量のCV内注水を実施した場合でも、再循環が「外の末端」が水没せず、再循環出口が開放した状態を維持できるため、ダクト開放機構を設置していない。</li> <li>・格納容器への注水状態においても、有効に機能するダクト開放部を評価対象とすることに相違はない。</li> </ul>

図1-9 格納容器再循環ユニット及びダクト開放機構配置概略図

赤字：設備、運用又は体制の相違（設計方針の相違）  
 青字：記載箇所又は記載内容の相違（記載方針の相違）  
 緑字：記載表現、設備名称の相違（実質的な相違なし）

第50条 原子炉格納容器の過圧破損を防止するための設備

大飯発電所3/4号炉

表1-1 各事故シナリオにおける再循環ファン・再循環ダクト吹出口の状況

有効性評価シナリオ	各シナリオでの状況	再循環ユニットでの除熱評価における条件	
	吹出口（最下部の先端）の水没状況 A系：E.L. 24.65m D系：E.L. 24.65m (格納容器内水位)	再循環ファンの稼働状況	想定する吹出口
原子炉補機冷却機能喪失 (全交流電源喪失 +RCP シール LOCA)	水没せず E.L. 約 19.5m (約 2,200m <sup>3</sup> )	考慮せず (自然対流冷却で評価)	E.L. 26.0m フロア設置吹出口 (E.L. 約 30.7m)
格納容器の除熱機能喪失 (大 LOCA+低圧再循環失敗 +格納容器スプレイ失敗)	水没せず E.L. 約 19.5m (約 2,200m <sup>3</sup> )		
格納容器過圧破損 (大 LOCA+ECCS 注入失敗 +格納容器スプレイ注入失敗)	水没せず E.L. 約 20.5m (約 3,400m <sup>3</sup> )		
格納容器過温破損 (全交流電源喪失+補助給水失敗)	水没せず E.L. 約 20.1m (約 2,900m <sup>3</sup> )		



図1-5 格納容器再循環ユニット配置概要図 (原子炉格納容器断面図)

48-8-36

泊発電所3号炉

表1-1 各事故シナリオにおける再循環ファン・再循環ダクト吹出口の状況

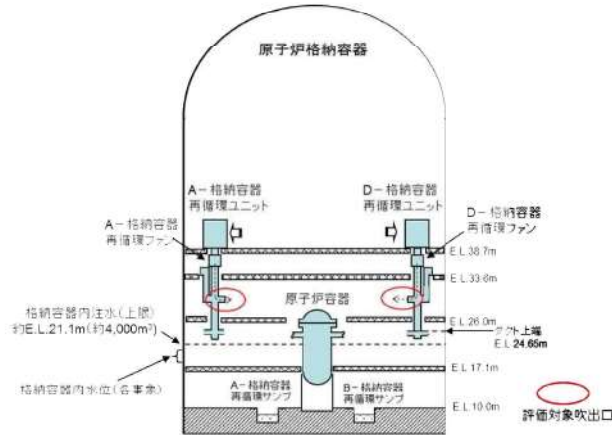
有効性評価シナリオ	各シナリオでの状況	再循環ユニットでの除熱評価における条件	
	吹出口（最下部）の水没状況 C, D系：T.P. 21.9m (格納容器内水位)	再循環ファンの稼働状況	想定する吹出口
原子炉補機冷却機能喪失 (全交流電源喪失 +RCP シール LOCA)	水没せず T.P. 約 13.7m (約 1,800m <sup>3</sup> )	考慮せず (自然対流冷却で評価)	ダクト開放機構
格納容器の除熱機能喪失 (大 LOCA+低圧再循環失敗 +格納容器スプレイ失敗)	水没せず T.P. 約 13.7m (約 1,800m <sup>3</sup> )		
格納容器過圧破損 (大 LOCA+ECCS 注入失敗 +格納容器スプレイ注入失敗)	水没せず T.P. 約 17.8m (約 3,600m <sup>3</sup> )		
格納容器過温破損 (全交流電源喪失+補助給水失敗)	水没せず T.P. 約 17.0m (約 3,200m <sup>3</sup> )		



図1-6 格納容器再循環ユニット配置概要図 (原子炉格納容器断面図)

48-7-34

相違理由

**設計方針の相違**

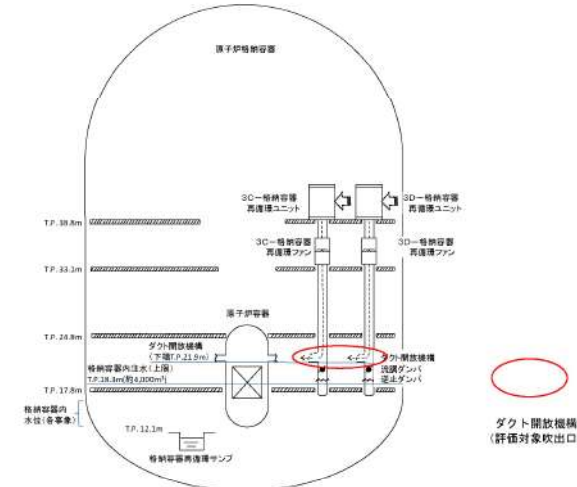
- ・POCVである大飯3/4号炉は、CV内再循環が「外のポンピング」、CV内構造が、鋼製CVの泊3号炉と異なり、大量のCV内注水を実施した場合でも、再循環が「外の末端」が水没せず、再循環出口が開放した状態を維持できるため、ダクト開放機構を設置していない。
- ・各有効性シナリオにおける格納容器内注水量で水没せず、自然対流冷却の効果のみを考慮する評価内容には相違なし。

赤字：設備、運用又は体制の相違（設計方針の相違）  
 青字：記載箇所又は記載内容の相違（記載方針の相違）  
 緑字：記載表現、設備名称の相違（実質的な相違なし）

第50条 原子炉格納容器の過圧破損を防止するための設備

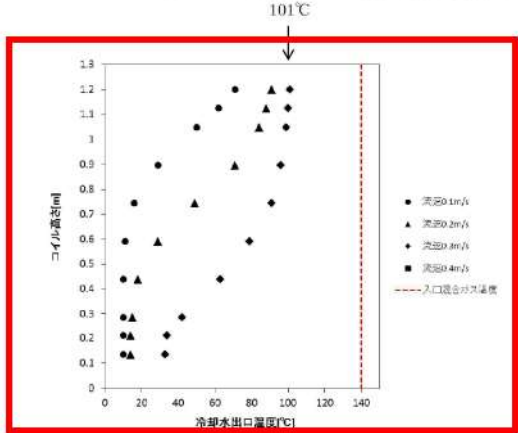
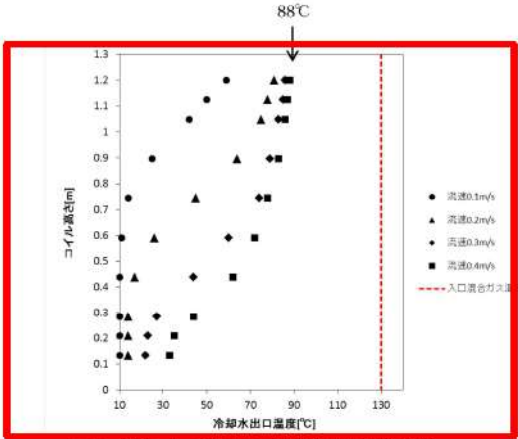
大飯発電所3/4号炉	泊発電所3号炉	相違理由																								
<p>参考資料-1 冷却コイル高さ方向での熱容量の裕度について</p> <p>格納容器再循環ユニット冷却コイル性能確認試験にて試験を実施した条件のうち、<b>大飯3、4号機</b>における格納容器最高使用圧力（<b>0.39MPaG≒5ata</b>）とほぼ同等な冷却コイル入口混合ガス条件（表1参照。圧力<b>5ata</b>、温度<b>140℃</b>）における冷却コイル高さ方向での冷却コイルの熱容量の余裕を確認するために、冷却コイル高さ方向での冷却水出口温度の分布を図1に整理した。</p> <p>図1を見ると、コイル高さが高いほど冷却水出口温度は高く、コイル高さが低いほど冷却水出口温度は低いことがわかる。冷却水の温度上昇分が除熱量であるため、コイル高さが高いほど除熱量が大きく、コイル高さが低いほど除熱量が小さいことがわかる。</p> <p>除熱量の最も大きい条件は、混合ガス流速<b>0.3m/s</b>におけるコイル高さ1.2mのポイントであり、このポイントでの冷却水出口温度は<b>101℃</b>であるので、混合ガス温度約<b>140℃</b>に比べて、約<b>40℃</b>の冷却水温度の余裕があることがわかる。</p> <p>表1 試験条件と実機条件との比較</p> <table border="1" data-bbox="331 683 842 798"> <thead> <tr> <th></th> <th>実験条件</th> <th>大飯3、4号機*</th> </tr> </thead> <tbody> <tr> <td>全圧</td> <td>5ata</td> <td>約5ata</td> </tr> <tr> <td>温度</td> <td>約140℃</td> <td>約140℃</td> </tr> <tr> <td>混合ガス流速</td> <td>0.1~0.3m/sec</td> <td>約0.2m/sec</td> </tr> </tbody> </table> <p>※大飯3、4号機における格納容器最高使用圧力での値</p>  <p>図1 冷却コイル高さ方向での冷却水出口温度分布</p>		実験条件	大飯3、4号機*	全圧	5ata	約5ata	温度	約140℃	約140℃	混合ガス流速	0.1~0.3m/sec	約0.2m/sec	<p>参考資料-1 冷却コイル高さ方向での熱容量の裕度について</p> <p>格納容器再循環ユニット冷却コイル性能確認試験にて試験を実施した条件のうち、<b>泊3号炉</b>における格納容器最高使用圧力（<b>0.283MPaG≒3.9ata</b>）とほぼ同等な冷却コイル入口混合ガス条件（表1参照。圧力<b>4ata</b>、温度<b>130℃</b>）における冷却コイル高さ方向での冷却コイルの熱容量の余裕を確認するために、冷却コイル高さ方向での冷却水出口温度の分布を図1に整理した。</p> <p>図1を見ると、コイル高さが高いほど冷却水出口温度は高く、コイル高さが低いほど冷却水出口温度は低いことがわかる。冷却水の温度上昇分が除熱量であるため、コイル高さが高いほど除熱量が大きく、コイル高さが低いほど除熱量が小さいことがわかる。</p> <p>除熱量の最も大きい条件は、混合ガス流速<b>0.4m/s</b>におけるコイル高さ1.2mのポイントであり、このポイントでの冷却水出口温度は<b>88℃</b>であるので、混合ガス温度約<b>130℃</b>に比べて、約<b>40℃</b>の冷却水温度の余裕があることがわかる。</p> <p>表1 試験条件と実機条件との比較</p> <table border="1" data-bbox="1182 676 1836 817"> <thead> <tr> <th></th> <th>実験条件</th> <th>泊3号炉*</th> </tr> </thead> <tbody> <tr> <td>全圧</td> <td>4ata</td> <td>約3.9ata</td> </tr> <tr> <td>温度</td> <td>約130℃</td> <td>約130℃</td> </tr> <tr> <td>混合ガス流速</td> <td>0.1~0.4m/sec</td> <td>約0.25m/sec</td> </tr> </tbody> </table> <p>※泊3号炉における格納容器最高使用圧力での値</p>  <p>図1 冷却コイル高さ方向での冷却水出口温度分布</p>		実験条件	泊3号炉*	全圧	4ata	約3.9ata	温度	約130℃	約130℃	混合ガス流速	0.1~0.4m/sec	約0.25m/sec	<p>相違理由</p> <p>設計の相違              ・格納容器型式の相違により、格納容器最高使用圧力の相違。</p> <p>設計の相違              ・格納容器最高使用圧力の相違により、参照する実験条件が相違。</p>
	実験条件	大飯3、4号機*																								
全圧	5ata	約5ata																								
温度	約140℃	約140℃																								
混合ガス流速	0.1~0.3m/sec	約0.2m/sec																								
	実験条件	泊3号炉*																								
全圧	4ata	約3.9ata																								
温度	約130℃	約130℃																								
混合ガス流速	0.1~0.4m/sec	約0.25m/sec																								



赤字：設備、運用又は体制の相違（設計方針の相違）  
 青字：記載箇所又は記載内容の相違（記載方針の相違）  
 緑字：記載表現、設備名称の相違（実質的な相違なし）

第50条 原子炉格納容器の過圧破損を防止するための設備

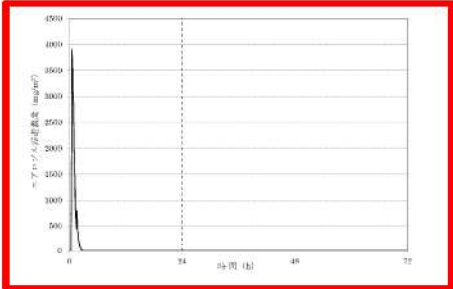
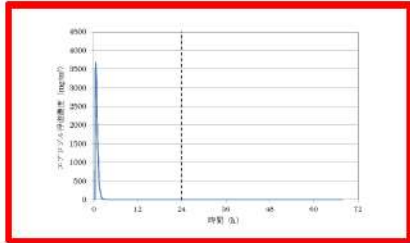
大飯発電所3/4号炉	泊発電所3号炉	相違理由
<p>参考資料-2 エアロゾルによる自然対流冷却除熱性能劣化について</p> <p>大飯3、4号機における格納容器破損防護対策の代表シナリオである「大破断 LOCA+ECCS 注入失敗+CV スプレイ失敗」シナリオでは格納容器内のエアロゾル浮遊濃度は、MAAP 解析の結果より最大で約 4000mg/m<sup>3</sup>である（図1）。これを見ると、事故時急激にエアロゾルが発生するが、代替 CV スプレイ水により3時間程度で除去されていることがわかる。</p> <p>一方、本シナリオにおける格納容器再循環ユニットによる自然対流冷却の開始時刻は、エアロゾルが除去されて以降であるので、自然対流冷却開始時点では格納容器内に有意なエアロゾルの浮遊はないことがわかる。</p> <p>従って、格納容器再循環ユニットによる自然対流冷却について、エアロゾルによる有意な除熱性能劣化の影響はないものと判断できる。</p>  <p>図1 エアロゾルの浮遊濃度（ドーム部）                      （大破断 LOCA+ECCS 注入失敗+CV スプレイ失敗+代替 CV スプレイ成功）シナリオ</p>	<p>参考資料-2 エアロゾルによる自然対流冷却除熱性能劣化について</p> <p>泊3号炉における格納容器破損防止対策の代表シナリオである「大破断 LOCA+ECCS 注入失敗+CV スプレイ失敗」シナリオでは格納容器内のエアロゾル浮遊濃度は、MAAP 解析の結果より最大で約 3700mg/m<sup>3</sup>である（図1）。これを見ると、事故時急激にエアロゾルが発生するが、代替 CV スプレイ水により3時間程度で除去されていることがわかる。</p> <p>一方、本シナリオにおける格納容器再循環ユニットによる自然対流冷却の開始時刻は、エアロゾルが除去されて以降であるので、自然対流冷却開始時点では格納容器内に有意なエアロゾルの浮遊はないことがわかる。</p> <p>従って、格納容器再循環ユニットによる自然対流冷却について、エアロゾルによる有意な除熱性能劣化の影響はないものと判断できる。</p>  <p>図1 エアロゾルの浮遊濃度（ドーム部）                      （大破断 LOCA+ECCS 注入失敗+CV スプレイ失敗+代替 CV スプレイ成功）シナリオ</p>	<p>相違理由</p> <p>解析結果の相違                      ・解析結果は相違するが、エアロゾルによる格納容器自然対流冷却における除熱性能への有意な影響はないことは同じである。</p>

赤字：設備、運用又は体制の相違（設計方針の相違）  
 青字：記載箇所又は記載内容の相違（記載方針の相違）  
 緑字：記載表現、設備名称の相違（実質的な相違なし）

第50条 原子炉格納容器の過圧破損を防止するための設備

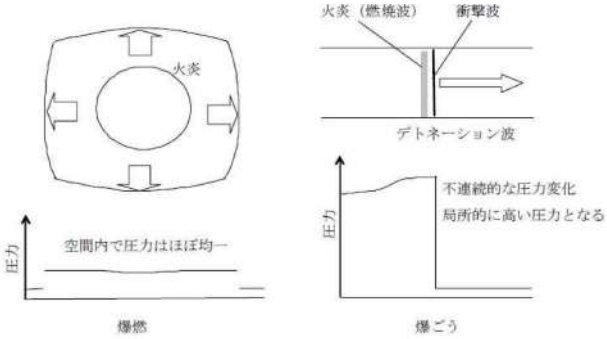
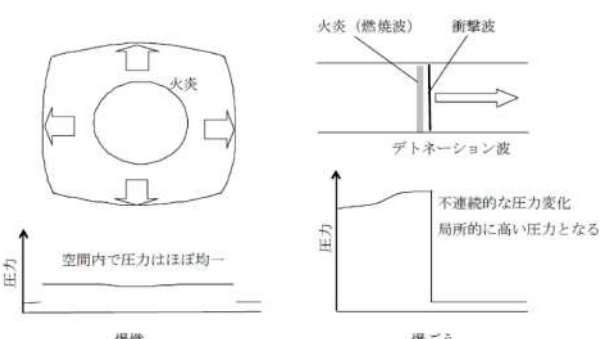
大飯発電所3/4号炉	泊発電所3号炉	相違理由
<p>参考資料-3 格納容器再循環ユニットのダクト内外での水素燃焼影響について</p> <p>1. はじめに</p> <p>本資料は、格納容器再循環ユニット内外の局所的な水素濃度上昇による水素燃焼の影響についてまとめたものである。なお、格納容器再循環ユニット内に着火源はないためユニット内からの水素燃焼は想定しがたいが、冷却コイル出口ではドライ環境のため入口より水素濃度が相対的に上昇することを踏まえ、念のために機器への影響を確認することを目的とする。</p> <p>2. 爆轟と爆燃における圧力伝播と圧力分布の違い</p> <p>爆轟では、火炎は音速を超えた速度で伝播するため、火炎の直前に衝撃波が形成され、火炎からのエネルギー放出により衝撃波が減衰することなく伝播し続けるものとなる。</p> <p>空間内の圧力分布を考えると、爆轟では火災伝播は圧力の伝わる速度より速く局所的に圧力が大きく上昇するため、非常に大きな被害が出やすいが、爆燃では圧力変化（音速で伝わる）は火炎伝播より十分速く空間内に伝わる。このため、燃焼による圧力上昇は閉空間全体で平均化される。</p> <p>イグナイタが着火する8%Vol程度の水素濃度では、火炎伝搬速度は小さく爆轟に至らないため、仮にダクト内又は外で着火・伝播しても、ダクトに有意な圧力（内外圧力差）は生じない。</p>  <p>図1 爆燃と爆轟での圧力分布(参考文献(1)より引用)</p>	<p>参考資料-3 格納容器再循環ユニットのダクト内外での水素燃焼影響について</p> <p>1. はじめに</p> <p>本資料は、格納容器再循環ユニット内外の局所的な水素濃度上昇による水素燃焼の影響についてまとめたものである。なお、格納容器再循環ユニット内に着火源はないためユニット内からの水素燃焼は想定しがたいが、冷却コイル出口ではドライ環境のため入口より水素濃度が相対的に上昇することを踏まえ、念のために機器への影響を確認することを目的とする。</p> <p>2. 爆轟と爆燃における圧力伝播と圧力分布の違い</p> <p>爆轟では、火炎は音速を超えた速度で伝播するため、火炎の直前に衝撃波が形成され、火炎からのエネルギー放出により衝撃波が減衰することなく伝播し続けるものとなる。</p> <p>空間内の圧力分布を考えると、爆轟では火災伝播は圧力の伝わる速度より速く局所的に圧力が大きく上昇するため、非常に大きな被害が出やすいが、爆燃では圧力変化（音速で伝わる）は火炎伝播より十分速く空間内に伝わる。このため、燃焼による圧力上昇は閉空間全体で平均化される。</p> <p>イグナイタが着火する8%vol程度の水素濃度では、火炎伝搬速度は小さく爆轟に至らないため、仮にダクト内又は外で着火・伝播しても、ダクトに有意な圧力（内外圧力差）は生じない。</p>  <p>図1 爆燃と爆轟での圧力分布(参考文献(1)より引用)</p>	

赤字：設備、運用又は体制の相違（設計方針の相違）  
 青字：記載箇所又は記載内容の相違（記載方針の相違）  
 緑字：記載表現、設備名称の相違（実質的な相違なし）

第50条 原子炉格納容器の過圧破損を防止するための設備

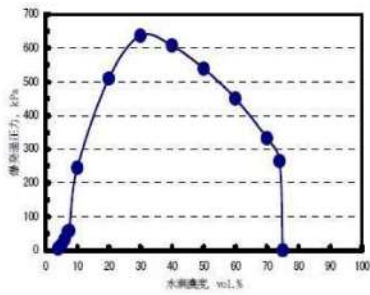
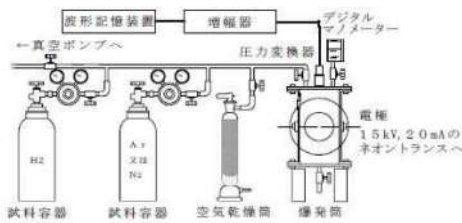
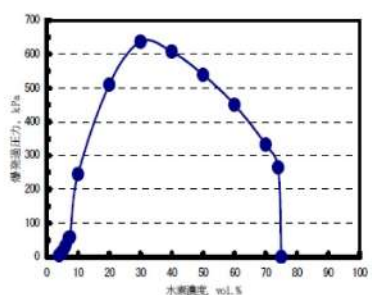
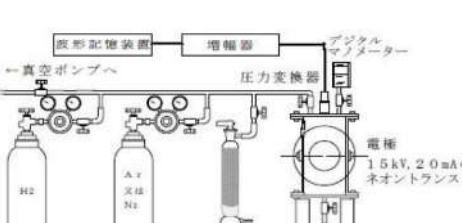
大飯発電所3 / 4号炉	泊発電所3号炉	相違理由
<p>3. 単純な体系での評価</p> <p>(1) 一般的な知見</p> <p>内容積 2L のステンレス製円筒容器 (102mm φ × 210H 観測窓付) を用い、着火は容器中心部において、電気スパーク (15kV のネオントランス) を用いて室温、大気圧下で行った水素/空気混合ガスの爆発圧力特性の測定結果を図 2 に、測定装置の概略を図 3 に示す。</p> <p>8%程度では、爆発過圧力は、100kPa~200kPa の間にある。</p>  <p>図 2 水素/空気混合ガスの爆発圧力(参考文献(1)より引用)</p>  <p>図 3 水素の爆発特性測定装置(参考文献(1)より引用)</p>	<p>3. 単純な体系での評価</p> <p>(1) 一般的な知見</p> <p>内容積 2L のステンレス製円筒容器 (102mm φ × 210H 観測窓付) を用い、着火は容器中心部において、電気スパーク (15kV のネオントランス) を用いて室温、大気圧下で行った水素/空気混合ガスの爆発圧力特性の測定結果を図 2 に、測定装置の概略を図 3 に示す。</p> <p>8%程度では、爆発過圧力は、100kPa~200kPa の間にある。</p>  <p>図 2 水素/空気混合ガスの爆発圧力(参考文献(1)より引用)</p>  <p>図 3 水素の爆発特性測定装置(参考文献(1)より引用)</p>	

赤字：設備、運用又は体制の相違（設計方針の相違）  
 青字：記載箇所又は記載内容の相違（記載方針の相違）  
 緑字：記載表現、設備名称の相違（実質的な相違なし）

第50条 原子炉格納容器の過圧破損を防止するための設備

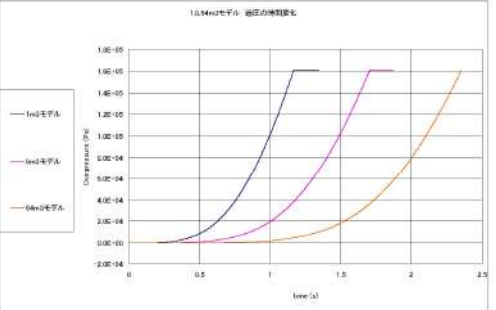
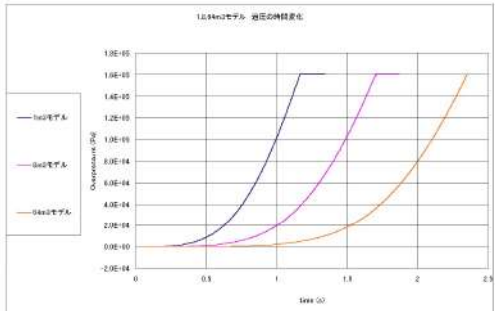
大飯発電所3/4号炉	泊発電所3号炉	相違理由																								
<p>(2) 火炎伝播解析による評価</p> <p>1m<sup>3</sup>、8m<sup>3</sup>及び64m<sup>3</sup>の立方体（閉空間）に一樣濃度の水素と空気との予混合気形成されている場合の最大過圧を水素の燃焼解析で求め、その計算結果を表1に示す。理論的には以下の式が成り立ち、水素濃度20%の計算結果は文献値より少し低めであるが、8%および30%を含めて、凡そ文献値とほぼ同じ値を示している。水素濃度8%程度の場合、計算では最大過圧は160kPaであった。</p> $\frac{P_2}{P_1} = \frac{n_2 T_2}{n_1 T_1} \quad \begin{matrix} 1: \text{燃焼前} \\ 2: \text{燃焼後} \end{matrix}$ <p>8%の水素が全て燃焼した時の到達圧力は、図4に示すとおり、容積（1m<sup>3</sup>、8m<sup>3</sup>及び64m<sup>3</sup>）が異なっても最大で160kPaであり、到達圧力が同じであることを確認した。なお、圧力の時間に伴う上昇は、体系内のどの地点でもほぼ同じ圧力のまま上昇していく結果となっている。このことは、図1に示した爆燃までの燃焼では、燃焼に伴う局所的な圧力の増加は体系内に速やかに均一化されることを裏付けている。</p> <p>以上より、8%の水素濃度で水素がすべて燃焼しても、区画内の設置されている機器の表面で圧力差は小さく、健全性が脅かされることはない。</p> <p style="text-align: center;">表1 最大過圧</p> <table border="1" data-bbox="403 742 772 869"> <thead> <tr> <th>H<sub>2</sub>濃度</th> <th>文献値(*)</th> <th>計算結果</th> </tr> </thead> <tbody> <tr> <td>8%</td> <td>100~200kPa</td> <td>160kPa</td> </tr> <tr> <td>20%</td> <td>500kPa</td> <td>400kPa</td> </tr> <tr> <td>30%</td> <td>640kPa</td> <td>600kPa</td> </tr> </tbody> </table> <p>(*)：参考文献1より引用</p>  <p style="text-align: center;">図4 1m<sup>3</sup>、8m<sup>3</sup>及び64m<sup>3</sup>での圧力変化（H<sub>2</sub>濃度8%）</p>	H <sub>2</sub> 濃度	文献値(*)	計算結果	8%	100~200kPa	160kPa	20%	500kPa	400kPa	30%	640kPa	600kPa	<p>(2) 火炎伝播解析による評価</p> <p>1m<sup>3</sup>、8m<sup>3</sup>及び64m<sup>3</sup>の立方体（閉空間）に一樣濃度の水素と空気との予混合気形成されている場合の最大過圧を水素の燃焼解析で求め、その計算結果を表1に示す。理論的には以下の式が成り立ち、水素濃度20%の計算結果は文献値より少し低めではあるが、8%および30%を含めて、凡そ文献値とほぼ同じ値を示している。水素濃度8%程度の場合、計算では最大過圧は160kPaであった。</p> $\frac{P_2}{P_1} = \frac{n_2 T_2}{n_1 T_1} \quad \begin{matrix} 1: \text{燃焼前} \\ 2: \text{燃焼後} \end{matrix}$ <p>8%の水素が全て燃焼した時の到達圧力は、図4に示すとおり、容積（1m<sup>3</sup>、8m<sup>3</sup>及び64m<sup>3</sup>）が異なっても最大で160kPaであり、到達圧力が同じであることを確認した。なお、圧力の時間に伴う上昇は、体系内のどの地点でもほぼ同じ圧力のまま上昇していく結果となっている。このことは、図1に示した爆燃までの燃焼では、燃焼に伴う局所的な圧力の増加は体系内に速やかに均一化されることを裏付けている。</p> <p>以上より、8%の水素濃度で水素がすべて燃焼しても、区画内の設置されている機器の表面で圧力差は小さく、健全性が脅かされることはない。</p> <p style="text-align: center;">表1 最大過圧</p> <table border="1" data-bbox="1276 742 1646 869"> <thead> <tr> <th>H<sub>2</sub>濃度</th> <th>文献値(*)</th> <th>計算結果</th> </tr> </thead> <tbody> <tr> <td>8%</td> <td>100~200kPa</td> <td>160kPa</td> </tr> <tr> <td>20%</td> <td>500kPa</td> <td>400kPa</td> </tr> <tr> <td>30%</td> <td>640kPa</td> <td>600kPa</td> </tr> </tbody> </table> <p>(*)：参考文献1より引用</p>  <p style="text-align: center;">図4 1m<sup>3</sup>、8m<sup>3</sup>及び64m<sup>3</sup>での圧力変化（H<sub>2</sub>濃度8%）</p>	H <sub>2</sub> 濃度	文献値(*)	計算結果	8%	100~200kPa	160kPa	20%	500kPa	400kPa	30%	640kPa	600kPa	
H <sub>2</sub> 濃度	文献値(*)	計算結果																								
8%	100~200kPa	160kPa																								
20%	500kPa	400kPa																								
30%	640kPa	600kPa																								
H <sub>2</sub> 濃度	文献値(*)	計算結果																								
8%	100~200kPa	160kPa																								
20%	500kPa	400kPa																								
30%	640kPa	600kPa																								

赤字：設備、運用又は体制の相違（設計方針の相違）  
 青字：記載箇所又は記載内容の相違（記載方針の相違）  
 緑字：記載表現、設備名称の相違（実質的な相違なし）

第50条 原子炉格納容器の過圧破損を防止するための設備

大飯発電所3/4号炉	泊発電所3号炉	相違理由									
<p>4. ダクト体系での確認</p> <p>これまでの知見では、配管類で爆轟が生じたのは、片端又は両端が閉ざされた閉空間で水素濃度が高濃度に蓄積したもので起こっているため、PWRのユニット・ダクトのような両端が開放された構造、水素濃度が低い（ドライ水素濃度13%未満）条件では爆轟は発生しないと考えられる。</p> <p>しかしながら、ダクト内では、火炎の伝播方向が限定され、火炎加速が比較的起こりやすいと考えられること、及びダクト内で水蒸気が凝縮して水素濃度が高濃度になる可能性を想定し、</p> <ul style="list-style-type: none"> <li>・ダクト内13%濃度均一（解析水蒸気凝縮による水素濃度増加を考慮し、GOTHIC解析のCVドライ平均水素濃度の最大値を包絡する値を設定）</li> <li>・ダクト外（部屋内）8%均一</li> <li>・ダクト内で何らかの理由で着火とダクト外のイグナイタでの着火の2通りを仮定の条件で火炎伝播及び圧力伝播解析により、爆燃の範囲でもダクトユニットの健全性に影響するような内外圧差が生じないことを評価した。</li> </ul> <p>4.1 ダクト内での着火</p> <p>(1) 解析体系</p> <p>解析体系を図5に示す。点火位置はダクト上部開口部の中央とした。</p> <p>(2) 解析結果</p> <p>図6に燃焼率カウンター図を示すとおり、区画内の燃焼は1秒以内で終わっている。ダクト内の圧力はダクト上部と中央部と下部の開口部から抜けるため内部からの圧力上昇値は高くない。この時の自然対流路（ダクト開口部より上側）の内外差圧は表2及び図7に示すとおりであり、過渡的にも再循環ユニットダクトの許容圧力内に収まる結果となった。</p> <table border="1" data-bbox="224 957 963 1117"> <caption>表2 自然対流路の内外圧差評価結果（ダクト内着火）</caption> <tr> <td>自然対流路の内外圧差最大値</td> <td>大飯3/4号機の再循環ユニットダクトの許容圧力</td> </tr> <tr> <td>約1.5 kPa</td> <td>約4.5 kPa(*)</td> </tr> </table> <p>(*)：耐圧試験による検証結果</p> <p>(2) 解析結果</p> <p>図6に燃焼率カウンター図を示すとおり、区画内の燃焼は1秒以内で終わっている。ダクト内の圧力はダクト上部と中央部の開口部から抜けるため内部からの圧力上昇値は高くないが、ダクト内での燃焼終了後もダクト外での燃焼が下部で続いているため、区画内の燃焼終了間際にダクト外部の圧力が内部に比べて若干高くなる。この時の自然対流路（ダクト開口部より上側）の内外差圧は表2及び図7に示すとおりであり、過渡的にも格納容器循環冷暖房ユニットダクトの許容圧力内に収まる結果となった。</p> <table border="1" data-bbox="649 1388 985 1436"> <tr> <td>本記載は、美浜3号炉の参考掲載</td> </tr> </table>	自然対流路の内外圧差最大値	大飯3/4号機の再循環ユニットダクトの許容圧力	約1.5 kPa	約4.5 kPa(*)	本記載は、美浜3号炉の参考掲載	<p>4. ダクト体系での確認</p> <p>これまでの知見では、配管類で爆轟が生じたのは、片端又は両端が閉ざされた閉空間で水素濃度が高濃度に蓄積したもので起こっているため、PWRのユニット・ダクトのような両端が開放された構造、水素濃度が低い（ドライ水素濃度13%未満）条件では爆轟は発生しないと考えられる。</p> <p>しかしながら、ダクト内では、火炎の伝播方向が限定され、火炎加速が比較的起こりやすいと考えられること、及びダクト内で水蒸気が凝縮して水素濃度が高濃度になる可能性を想定し、</p> <ul style="list-style-type: none"> <li>・ダクト内13%濃度均一（解析水蒸気凝縮による水素濃度増加を考慮し、GOTHIC解析のCVドライ平均水素濃度の最大値を包絡する値を設定）</li> <li>・ダクト外（部屋内）8%均一</li> <li>・ダクト内で何らかの理由で着火とダクト外のイグナイタでの着火の2通りを仮定の条件で火炎伝播及び圧力伝播解析により、爆燃の範囲でもダクトユニットの健全性に影響するような内外圧差が生じないことを評価した。</li> </ul> <p>4.1 ダクト内での着火</p> <p>(1) 解析体系</p> <p>解析体系を図5に示す。点火位置はダクト上部開口部の中央とした。</p> <p>(2) 解析結果</p> <p>図6に燃焼率カウンター図を示すとおり、区画内の燃焼は1秒以内で終わっている。ダクト内の圧力はダクト上部と中央部の開口部から抜けるため内部からの圧力上昇値は高くないが、ダクト内での燃焼終了後もダクト外での燃焼が下部で続いているため、区画内の燃焼終了間際にダクト外部の圧力が内部に比べて若干高くなる。この時の自然対流路（ダクト開口部より上側）の内外差圧は表2及び図7に示すとおりであり、過渡的にも再循環ユニットダクトの許容圧力内に収まる結果となった。</p> <table border="1" data-bbox="1142 957 1859 1117"> <caption>表2 自然対流路の内外圧差評価結果</caption> <tr> <td>自然対流路の内外圧差最大値</td> <td>泊3号炉の再循環ユニットダクトの許容圧力</td> </tr> <tr> <td>約7kPa</td> <td>約19.6kPa(*)</td> </tr> </table> <p>(*)：カタログ保証値</p>	自然対流路の内外圧差最大値	泊3号炉の再循環ユニットダクトの許容圧力	約7kPa	約19.6kPa(*)	<p>相違理由</p> <p>設計の相違</p> <ul style="list-style-type: none"> <li>・泊3号炉には、ダクト下部に開口部はない。ダクト体系内の開口部から圧力が抜けることに相違はない。</li> <li>・ダクト開口部の相違</li> <li>・ダクト開口部がダクト下部にも設置している大飯3/4号炉では、ダクト内外差圧が解消しやすい体系。</li> <li>・泊3号炉は、ダクト下部に開口部がないため、下部区画のダクト外の燃焼影響によりダクト内外差圧が大飯に比較し大きくなりやすい体系。（高浜3/4号炉、美浜3号炉と同様）</li> <li>・いずれにおいてもダクトの許容圧力未満であることは同じである。</li> </ul>
自然対流路の内外圧差最大値	大飯3/4号機の再循環ユニットダクトの許容圧力										
約1.5 kPa	約4.5 kPa(*)										
本記載は、美浜3号炉の参考掲載											
自然対流路の内外圧差最大値	泊3号炉の再循環ユニットダクトの許容圧力										
約7kPa	約19.6kPa(*)										

赤字：設備、運用又は体制の相違（設計方針の相違）  
 青字：記載箇所又は記載内容の相違（記載方針の相違）  
 緑字：記載表現、設備名称の相違（実質的な相違なし）

第50条 原子炉格納容器の過圧破損を防止するための設備

大飯発電所3/4号炉	泊発電所3号炉	相違理由												
<p>4. 2 ダクト外での着火</p> <p>(1) 解析体系 解析体系を図8に示す。着火点は実機の離隔距離を踏まえ、ダクトから3mとした。</p> <p>(2) 解析結果 図9に燃焼率コンター図を示すとおり、区画内の燃焼は1秒以内で終わっている。</p> <p>ダクト下端部に到達した火炎は、ダクト下端部よりダクト内にも伝播し、ダクト内外を広がっていく。その後、火炎はダクト上部を抜け、火炎は消失している。火炎伝播の時間差によりダクト内外の圧力差が生じるが、自然対流路（ダクト開口部より上側）の内外差圧は最大でも表3及び図10に示すとおりであり、過渡的にも再循環ダクトの許容圧力内に収まる結果となった。</p> <table border="1" data-bbox="302 662 855 798"> <caption>表3 自然対流路の内外圧差評価結果（ダクト外着火）</caption> <tr> <td>自然対流路の内外圧差最大値</td> <td>大飯3/4号機の再循環ユニットダクトの許容圧力</td> </tr> <tr> <td>約3kPa</td> <td>約4.5kPa(*)</td> </tr> <tr> <td colspan="2">(*)：耐圧試験による検証結果</td> </tr> </table> <p>(2) 解析結果 図9の燃焼率コンター図に示すとおり、区画内の燃焼は1秒以内で終わっている。</p> <p>ダクト下端部が閉口であるため、火炎はダクトの外側を取り囲むように進む。火炎がダクト中央部に到達すると、ダクト中央部からダクト内部にも広がり、ダクト内においても上下方向に進むが、ダクト内の下方へ火炎伝播は、上方と比べ、下端が閉構造のため、閉端部での圧力が次第に高くなることからダクト内下端方向への燃焼ガス膨張が妨げられ、火炎はダクト外側よりも緩やかに伝播している。その後、火炎はダクト上部を抜け、火炎は消失している。火炎伝播の時間差によりダクト内外の圧力差が生じるが、自然対流路（ダクト開口部より上側）の内外差圧は最大でも表3及び図10に示すとおりであり、過渡的にもダクトの許容圧力内に収まる結果となった。</p> <div data-bbox="645 1241 996 1284" style="border: 1px solid black; padding: 2px; width: fit-content; margin-left: auto;"> <p>本記載は、美浜3号炉の参考掲載</p> </div>	自然対流路の内外圧差最大値	大飯3/4号機の再循環ユニットダクトの許容圧力	約3kPa	約4.5kPa(*)	(*)：耐圧試験による検証結果		<p>4. 2 ダクト外での着火</p> <p>(1) 解析体系 解析体系を図8に示す。着火点は実機の離隔距離を踏まえ、ダクトから3mとした。</p> <p>(2) 解析結果 図9の燃焼率コンター図に示すとおり、区画内の燃焼は1秒以内で終わっている。</p> <p>ダクト下端部が閉口であるため、火炎はダクトの外側を取り囲むように進む。火炎がダクト中央部に到達すると、ダクト中央部からダクト内部にも広がり、ダクト内においても上下方向に進むが、ダクト内の下方へ火炎伝播は、上方と比べ、下端が閉構造のため、閉端部での圧力が次第に高くなることからダクト内下端方向への燃焼ガス膨張が妨げられ、火炎はダクト外側よりも緩やかに伝播している。その後、火炎はダクト上部を抜け、火炎は消失している。火炎伝播の時間差によりダクト内外の圧力差が生じるが、自然対流路（ダクト開口部より上側）の内外差圧は最大でも表3及び図10に示すとおりであり、過渡的にも再循環ダクトの許容圧力内に収まる結果となった。</p> <table border="1" data-bbox="1102 662 1921 790"> <caption>表3 自然対流路の内外圧力差評価結果</caption> <tr> <td>自然対流路の内外圧力差最大値</td> <td>再循環ダクトの許容圧力</td> </tr> <tr> <td>約4.4kPa</td> <td>約19.6kPa(*)</td> </tr> <tr> <td colspan="2">(*)：カタログ保証値</td> </tr> </table>	自然対流路の内外圧力差最大値	再循環ダクトの許容圧力	約4.4kPa	約19.6kPa(*)	(*)：カタログ保証値		<p>相違理由</p> <p><b>設計の相違</b>          ・泊3号炉には、ダクト下部に開口部はない。ダクト体系内の開口部からダクト内へ火炎伝播する燃焼状態に相違はない。</p> <p><b>ダクト開口箇所の相違</b>          ・ダクト開口部がダクト下部にも設置している大飯3/4号炉では、ダクト下端から上端へと火炎伝播する体系。          ・泊3号炉は、ダクト下部に開口部がないため、ダクト中央部開口からダクト内に火炎伝播し、開口している上方への火炎伝播がしやすい体系。（高浜3/4号炉、美浜3号炉と同様）          ・いずれにおいてもダクトの許容圧力未達であることは同じである。</p>
自然対流路の内外圧差最大値	大飯3/4号機の再循環ユニットダクトの許容圧力													
約3kPa	約4.5kPa(*)													
(*)：耐圧試験による検証結果														
自然対流路の内外圧力差最大値	再循環ダクトの許容圧力													
約4.4kPa	約19.6kPa(*)													
(*)：カタログ保証値														

赤字：設備、運用又は体制の相違（設計方針の相違）  
 青字：記載箇所又は記載内容の相違（記載方針の相違）  
 緑字：記載表現、設備名称の相違（実質的な相違なし）

第50条 原子炉格納容器の過圧破損を防止するための設備

大飯発電所3/4号炉	泊発電所3号炉	相違理由
<p>5. まとめ</p> <p>解析によるダクト体系での確認により、最も厳しいと考えられる水素濃度が高い条件で燃焼したとしても、ダクトに損傷を与える程度の圧力差は生じないことを確認した。</p> <p>また、温度の面については、燃焼時の雰囲気温度は上昇するが、周囲の壁等への放熱（主に輻射熱伝達）により低下する。この雰囲気温度変化に対して、金属機器類は、雰囲気より大きな熱容量を持つため、温度の上昇は緩やかとなる。例として、8%水素濃度均一区画内での燃焼を解析した結果、ダクトのような薄板の機器であっても燃焼時の表面温度の上昇は約40℃以下となり、ダクト構造に影響を及ぼすことは考えられない。</p> <p>以上より、格納容器再循環ユニット内外で万一水素が燃焼した場合を仮定しても、機器の機能に影響を及ぼすことはないとする。</p> <p>参考文献(1) 水素の有効利用ガイドブック 平成20年3月                  (独) 新エネルギー・産業技術総合開発機構</p>	<p>5. まとめ</p> <p>解析によるダクト体系での確認により、最も厳しいと考えられる水素濃度が高い条件で燃焼したとしても、ダクトに損傷を与える程度の圧力差は生じないことを確認した。</p> <p>また、温度の面については、燃焼時の雰囲気温度は上昇するが、周囲の壁等への放熱（主に輻射熱伝達）により低下する。この雰囲気温度変化に対して、金属機器類は、雰囲気より大きな熱容量を持つため、温度の上昇は緩やかとなる。例として、8%水素濃度均一区画内での燃焼を解析した結果、ダクトのような薄板の機器であっても燃焼時の表面温度の上昇は約40℃以下となり、ダクト構造に影響を及ぼすことは考えられない。</p> <p>以上より、格納容器再循環ユニット内で万一水素が燃焼した場合を仮定しても、機器の機能に影響を及ぼすことはないとする。</p> <p>参考文献(1) 水素の有効利用ガイドブック 平成20年3月                  (独) 新エネルギー・産業技術総合開発機構</p>	

赤字：設備、運用又は体制の相違（設計方針の相違）  
 青字：記載箇所又は記載内容の相違（記載方針の相違）  
 緑字：記載表現、設備名称の相違（実質的な相違なし）

第50条 原子炉格納容器の過圧破損を防止するための設備

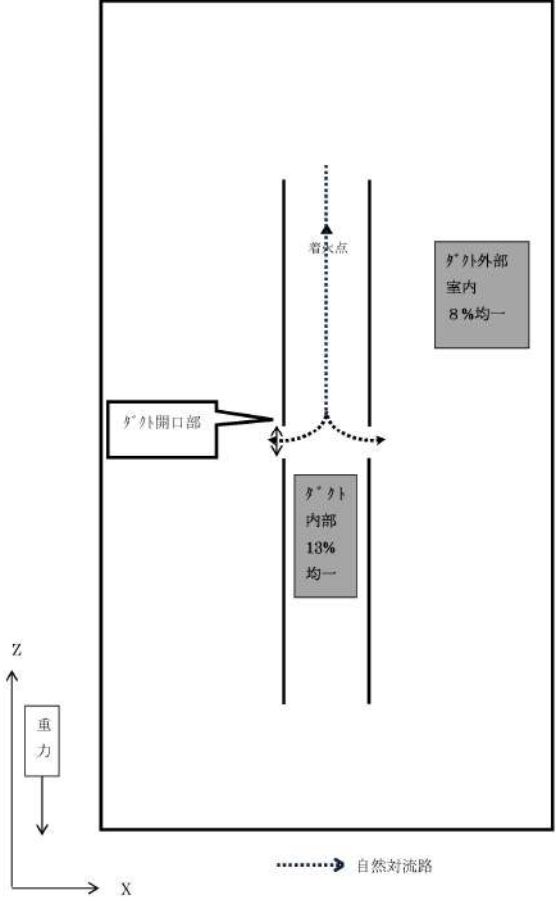
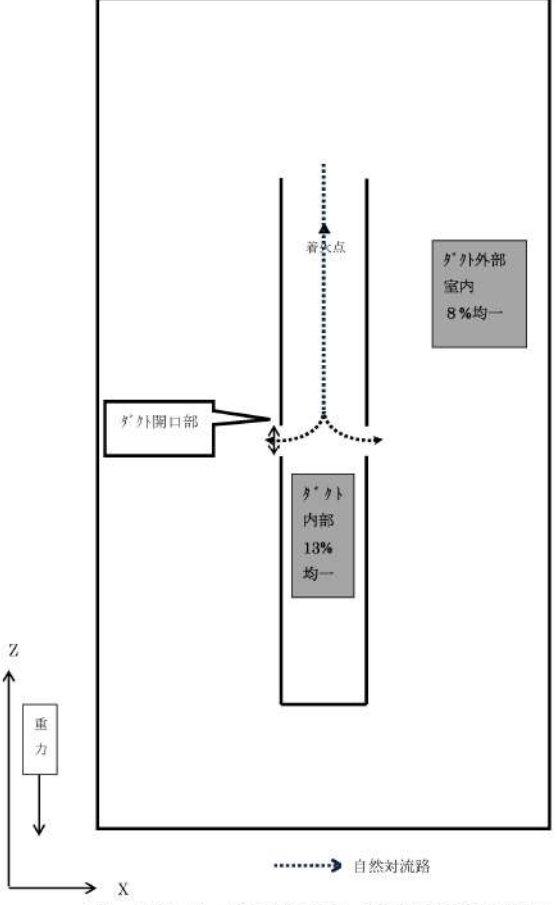
大飯発電所3 / 4号炉	泊発電所3号炉	相違理由
 <p>図5 ダクト内外火炎伝播解析体系図 X-Z断面 (Y-Z断面も同様)</p>	 <p>図5 ダクト内外火炎伝播解析体系図 X-Z断面 (Y-Z断面も同様)</p>	



赤字：設備、運用又は体制の相違（設計方針の相違）  
 青字：記載箇所又は記載内容の相違（記載方針の相違）  
 緑字：記載表現、設備名称の相違（実質的な相違なし）

第50条 原子炉格納容器の過圧破損を防止するための設備

大飯発電所3 / 4号炉		泊発電所3号炉		相違理由
時間	水素燃焼率コンター図 (単位 kg/s/m <sup>3</sup> )	時間	水素燃焼率コンター図 (単位 kg/s/m <sup>3</sup> )	<p>設計の相違</p> <ul style="list-style-type: none"> <li>・泊3号炉には、                      炉外下部に開口部                      はない。炉外体系                      内の開口部から圧                      力が抜けることに                      相違はない。</li> </ul>
0.3 sec		0.3 sec		
0.6 sec		0.6 sec		
0.8 sec		0.7 sec		
0.9 sec		0.8 sec		
		0.9 sec		
		1.0 sec		

図6 水素燃焼率コンター図

図6 水素燃焼率コンター図

赤字：設備、運用又は体制の相違（設計方針の相違）  
 青字：記載箇所又は記載内容の相違（記載方針の相違）  
 緑字：記載表現、設備名称の相違（実質的な相違なし）

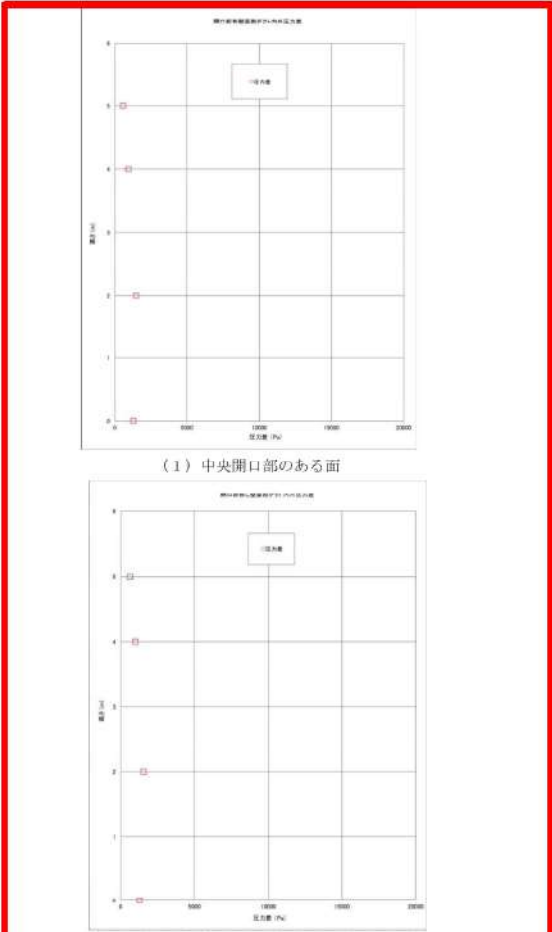
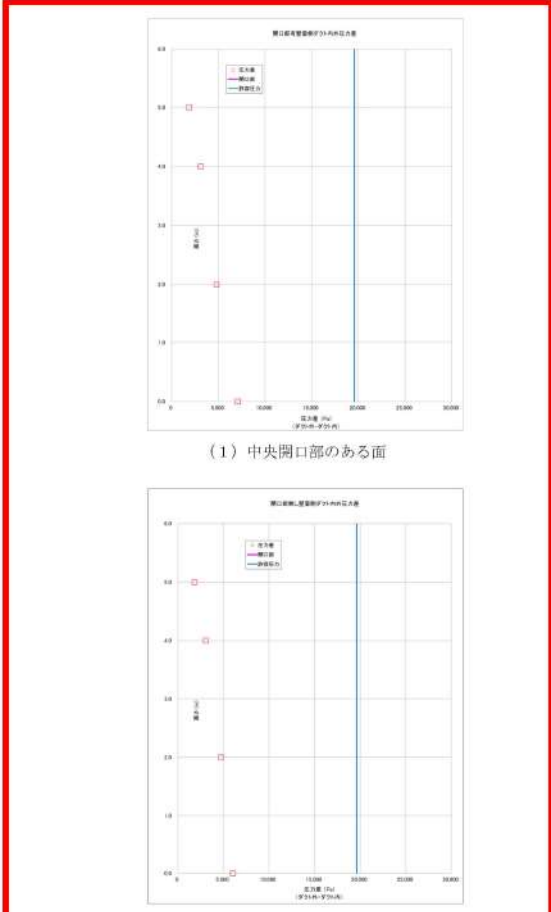
大飯発電所 3 / 4 号炉	泊発電所 3 号炉	相違理由
<div style="border: 2px solid red; padding: 10px;">  <p>(1) 中央開口部のある面</p> <p>(2) 中央開口部のない面</p> <p>図 7 軸方向位置におけるダクト内外圧力差 (0.961 s)</p> </div>	<div style="border: 2px solid red; padding: 10px;">  <p>(1) 中央開口部のある面</p> <p>(2) 中央開口部のない面</p> <p>図 7 軸方向位置におけるダクト内外圧力差 (0.955 s)</p> </div>	<p>ダクト開口箇所の相違</p> <ul style="list-style-type: none"> <li>・ダクト開口部がダクト下部にも設置している大飯3/4号炉では、ダクト内外差圧が解消しやすい体系。</li> <li>・泊3号炉は、ダクト下部に開口部がないため、下部区画のダクト外の燃焼影響によりダクト内外差圧が大飯に比較し大きくなりやすい体系。(高浜3/4号炉、美浜3号炉と同様)</li> </ul>

赤字：設備、運用又は体制の相違（設計方針の相違）  
 青字：記載箇所又は記載内容の相違（記載方針の相違）  
 緑字：記載表現、設備名称の相違（実質的な相違なし）

第50条 原子炉格納容器の過圧破損を防止するための設備

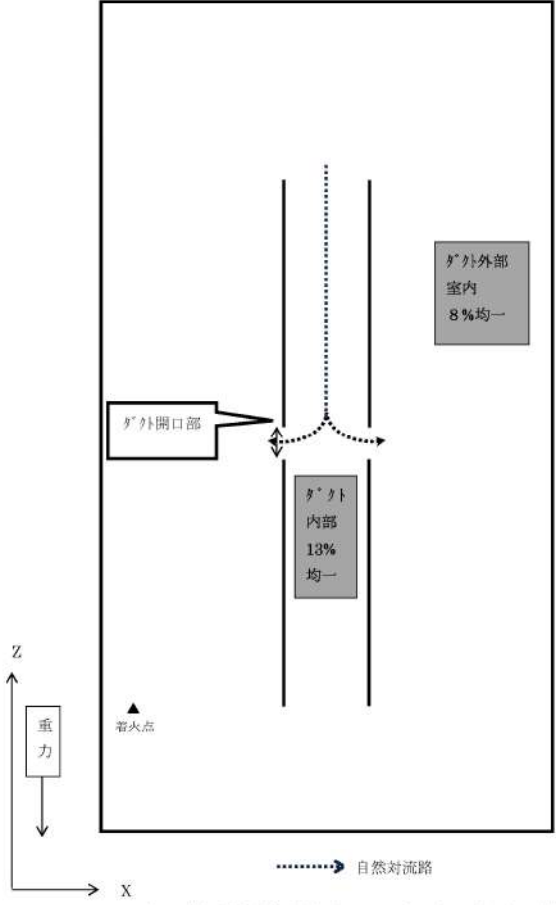
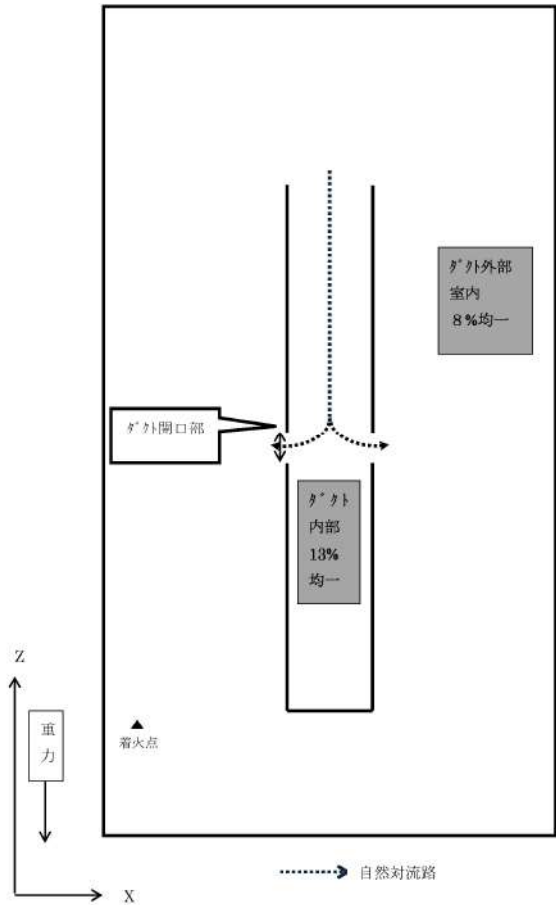
大飯発電所3/4号炉	泊発電所3号炉	相違理由
 <p>図8 ダクト内外火炎伝播解析体系図 X-Z断面 (Y-Z断面も同様)</p>	 <p>図8 ダクト内外火炎伝播解析体系図 X-Z断面 (Y-Z断面も同様)</p>	

赤字：設備、運用又は体制の相違（設計方針の相違）  
 青字：記載箇所又は記載内容の相違（記載方針の相違）  
 緑字：記載表現、設備名称の相違（実質的な相違なし）

第50条 原子炉格納容器の過圧破損を防止するための設備

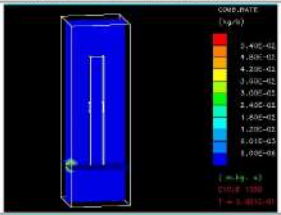
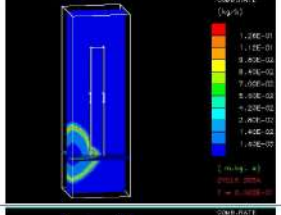
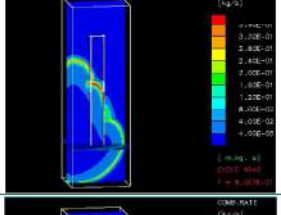
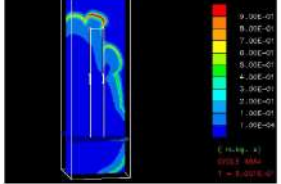
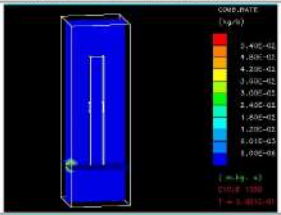
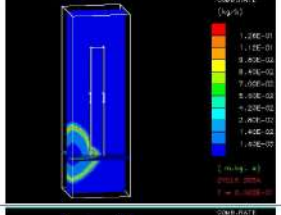
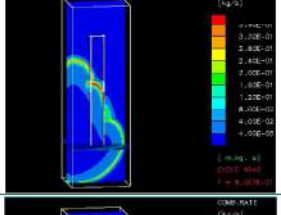
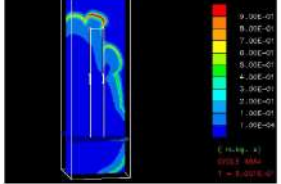
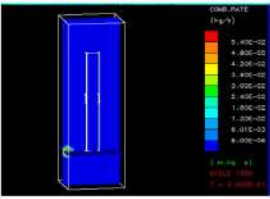
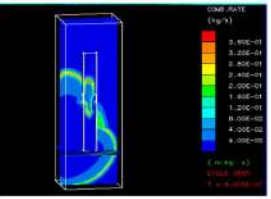
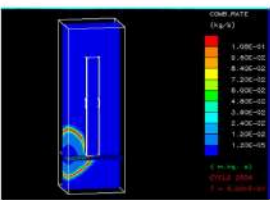
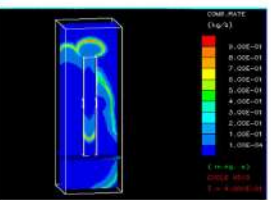
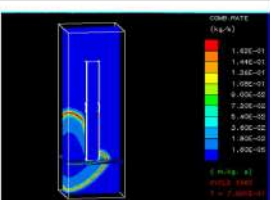
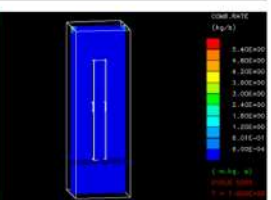
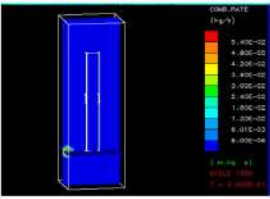
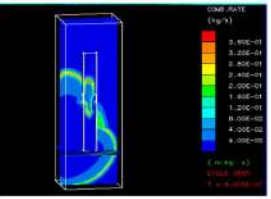
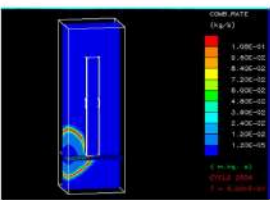
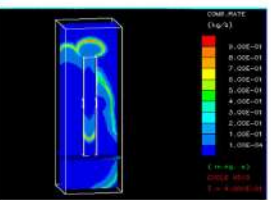
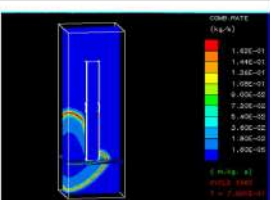
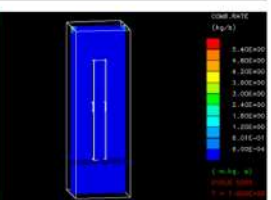
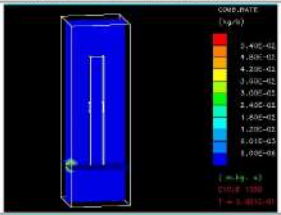
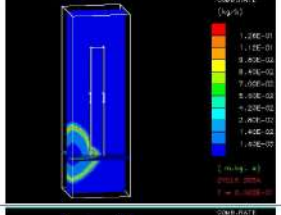
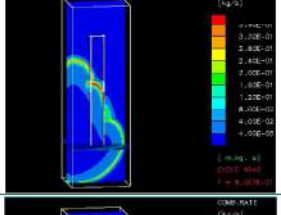
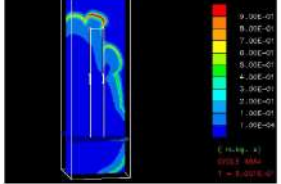
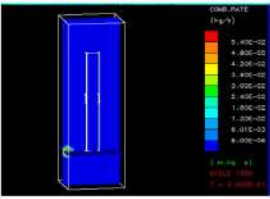
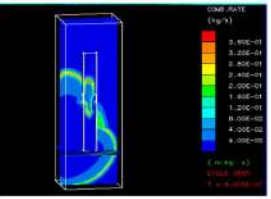
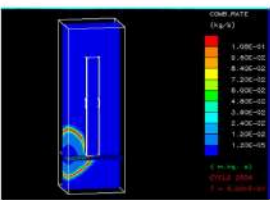
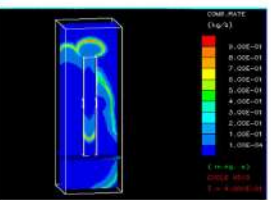
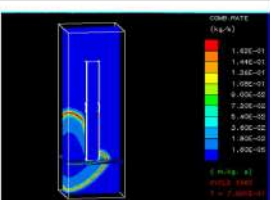
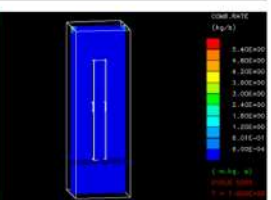
大飯発電所3/4号炉	泊発電所3号炉	相違理由																										
<div data-bbox="376 295 795 1193" style="border: 2px solid red; padding: 5px;"> <table border="1"> <thead> <tr> <th>時間</th> <th>水素燃焼率コンター図 (単位 kg/s/m<sup>3</sup>)</th> </tr> </thead> <tbody> <tr> <td>0.3 sec</td> <td></td> </tr> <tr> <td>0.6 sec</td> <td></td> </tr> <tr> <td>0.8 sec</td> <td></td> </tr> <tr> <td>0.9 sec</td> <td></td> </tr> </tbody> </table> </div> <p data-bbox="481 1204 683 1236">図9 水素燃焼率コンター図</p>	時間	水素燃焼率コンター図 (単位 kg/s/m <sup>3</sup> )	0.3 sec		0.6 sec		0.8 sec		0.9 sec		<div data-bbox="1164 295 1881 1061" style="border: 2px solid red; padding: 5px;"> <table border="1"> <thead> <tr> <th>時間</th> <th>水素燃焼率コンター図 (単位 kg/s/m<sup>3</sup>)</th> <th>時間</th> <th>水素燃焼率コンター図 (単位 kg/s/m<sup>3</sup>)</th> </tr> </thead> <tbody> <tr> <td>0.3 sec</td> <td></td> <td>0.8 sec</td> <td></td> </tr> <tr> <td>0.6 sec</td> <td></td> <td>0.9 sec</td> <td></td> </tr> <tr> <td>0.7 sec</td> <td></td> <td>1.0 sec</td> <td></td> </tr> </tbody> </table> <p data-bbox="1736 1029 1825 1061">(単位 kg/s)</p> </div> <p data-bbox="1400 1061 1624 1085">図9 水素燃焼率コンター図</p>	時間	水素燃焼率コンター図 (単位 kg/s/m <sup>3</sup> )	時間	水素燃焼率コンター図 (単位 kg/s/m <sup>3</sup> )	0.3 sec		0.8 sec		0.6 sec		0.9 sec		0.7 sec		1.0 sec		<p data-bbox="1971 311 2072 335"><u>設計の相違</u></p> <ul style="list-style-type: none"> <li data-bbox="1971 343 2128 566">・泊3号炉には、<u>ダクト下部に開口部はない。ダクト体系内の開口部からダクト内へ火炎伝播する燃焼様態に相違はない。</u></li> <li data-bbox="1971 582 2128 646"><u>ダクト開口箇所の相違</u></li> <li data-bbox="1971 654 2128 837">・ダクト開口部がダクト下部にも設置している大飯3/4号炉では、<u>ダクト下端から上端へと火炎伝播する体系。</u></li> <li data-bbox="1971 853 2128 1189">・泊3号炉は、<u>ダクト下部に開口部がないため、ダクト中央部開口からダクト内に火炎伝播し、開口している上方への火炎伝播がしやすい体系。(高浜3/4号炉、美浜3号炉と同様)</u></li> </ul>
時間	水素燃焼率コンター図 (単位 kg/s/m <sup>3</sup> )																											
0.3 sec																												
0.6 sec																												
0.8 sec																												
0.9 sec																												
時間	水素燃焼率コンター図 (単位 kg/s/m <sup>3</sup> )	時間	水素燃焼率コンター図 (単位 kg/s/m <sup>3</sup> )																									
0.3 sec		0.8 sec																										
0.6 sec		0.9 sec																										
0.7 sec		1.0 sec																										

赤字：設備、運用又は体制の相違（設計方針の相違）  
 青字：記載箇所又は記載内容の相違（記載方針の相違）  
 緑字：記載表現、設備名称の相違（実質的な相違なし）

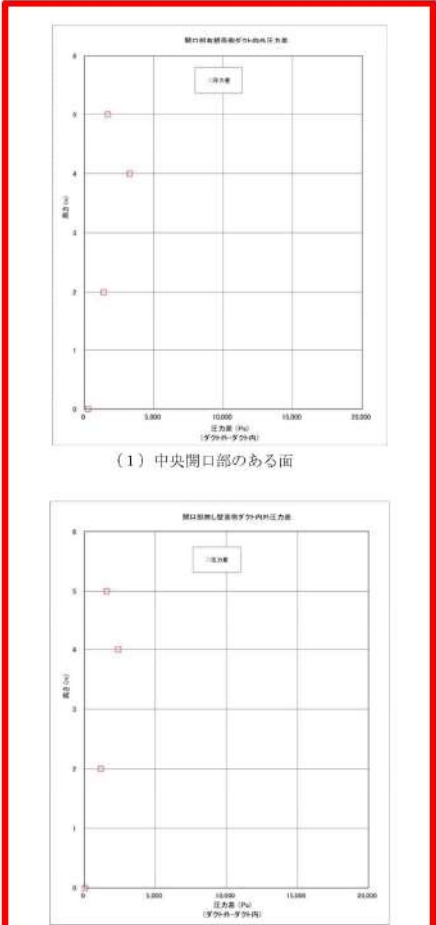
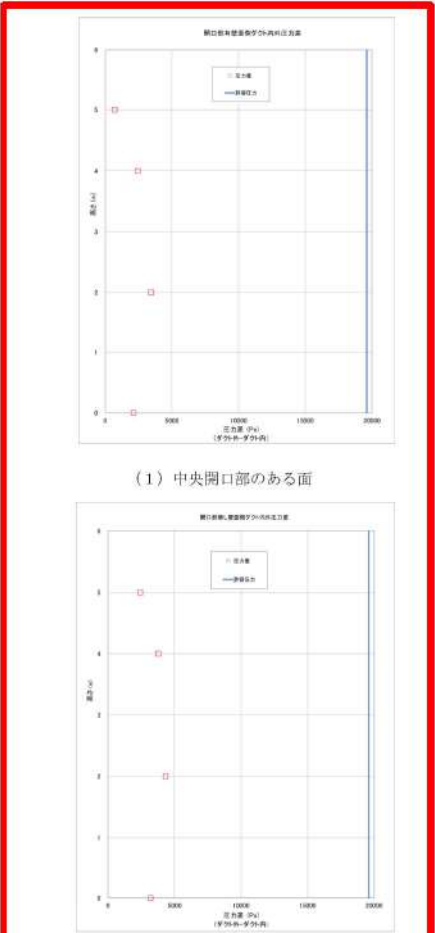
大飯発電所 3 / 4 号炉	泊発電所 3 号炉	相違理由
<div style="border: 2px solid red; padding: 10px;">  <p>(1) 中央開口部のある面</p> <p>(2) 中央開口部のない面</p> <p>図 1 0 軸方向位置におけるダクト内外圧力差 (0.857s)</p> </div>	<div style="border: 2px solid red; padding: 10px;">  <p>(1) 中央開口部のある面</p> <p>(2) 中央開口部の内面</p> <p>図 1 0 軸方向位置におけるダクト内外圧力差 (1.006 s)</p> </div>	<p>が外開口箇所の相違</p> <ul style="list-style-type: none"> <li>・が外開口部がが外下部にも設置している大飯3/4号炉では、が外下端から上端へと火炎伝播する体系。</li> <li>・泊3号炉は、が下部に開口部がないため、が外中央部開口からが外内に火炎伝播し、開口している上方への火炎伝播がしやすい体系。(高浜3/4号炉、美浜3号炉と同様)</li> </ul>

赤字：設備、運用又は体制の相違（設計方針の相違）  
 青字：記載箇所又は記載内容の相違（記載方針の相違）  
 緑字：記載表現、設備名称の相違（実質的な相違なし）

第50条 原子炉格納容器の過圧破損を防止するための設備

大飯発電所3/4号炉	泊発電所3号炉	相違理由
<p style="text-align: center;">(参考)</p> <p style="text-align: center;">過去の燃焼試験の整理からの考察</p> <p>過去の水素燃焼に関する試験等の知見を表1に整理した。上表に開放空間またはX, Y, Zの寸法が同等の閉囲空間での水素燃焼試験の条件を、下表に細長い閉囲空間（管路、ダクト系）での水素燃焼試験の条件を示している。爆轟が発生するのは、過去の試験等では、下表のような細長い配管類に水素と支燃性ガスがドライに近い条件で閉じ込められた場合であり、ダクト・配管以外の広い空間での火炎伝播試験の体系では、水素濃度が13~15%（ドライ水素濃度）でも、爆轟は発生していない。ウェット条件になるとさらに高濃度の水素でも発生していない。</p> <p>また、過去の細長い体系（管路、ダクト）での水素燃焼試験結果と再循環ダクトの体系の比較を表2に示す。</p> <p>RUT試験から、約11%未満の水素濃度では、障害物の有無に係らず、爆燃止まりであるのに対して、12.5%以上の水素濃度では障害物がある場合にのみ爆轟が発生している。</p> <p>労働省産業安全研究所の試験では、両端又は片端が閉の場合には、障害物の有無に係らず爆轟が発生している。この結果から、両端又は片端が閉の場合では、障害物がなくても配管の長さとの比(L/D)が大きく、30%程度の高水素濃度の場合は爆轟に転移する可能性が高いことが分かる。</p> <p>SRIの試験結果においては、両端が開放の場合でも水素濃度30%の水素濃度で障害物がある場合に爆轟が発生している。この結果から、配管の両端が開口の場合でも、L/Dが大きく、30%程度の高水素濃度で障害物がある場合には、爆轟が発生する可能性があることが分かる。</p> <p>NUPECの大規模試験は、内径8mの球体系(270m<sup>3</sup>)で多区画(11区画)である特徴があり、この球体系の中に円周約16m、口径1mのドーナツ状八角形空間があるが、15%（ドライ）大気圧の条件でも爆轟は発生していない。この結果から、複数の開口部があり、L/Dが20未満と比較的小さい体系では、15%程度の水素濃度でも爆轟は発生しない傾向にあることが分かる。</p> <p>以上を整理すると、爆轟発生条件として、以下の条件が挙げられる。</p> <ul style="list-style-type: none"> <li>✓水素濃度が12.5%未満では障害物の存在に依存しないが、12.5%以上では水素濃度と共に障害物が存在した方が爆轟の可能性が高まる。</li> <li>✓配管の両端が開口の場合でも、L/Dが大きく、30%程度の高水素濃度で障害物がある場合には、爆轟が発生する可能性がある。</li> <li>✓両端又は片端が閉の場合では、障害物がなくてもL/Dが大きく、30%程度の高水素濃度の場合に爆轟に転移する可能性が高い。</li> <li>✓L/Dが20未満と比較的小さい体系では、15%程度の水素濃度でも爆轟は発生していない。</li> </ul> <p>実機での細長い体系である再循環ダクトでは、保守的に水蒸気凝縮による水素濃度増加を考慮し、GOTHIC解析のCVドライ平均水素濃度の最大値を包絡する値として、ダクト内の水素濃度を保守的に13%とした場合においても、開放された系であり、ダクト内には障害物がない。また、L/Dも10未満であり、過去の爆轟事例のいずれの条件にも当てはまらない。</p>	<p style="text-align: center;">(参考)</p> <p style="text-align: center;">過去の燃焼試験の整理からの考察</p> <p>過去の水素燃焼に関する試験等の知見を表1に整理した。上表に開放空間またはX, Y, Zの寸法が同等の閉囲空間での水素燃焼試験の条件を、下表に細長い閉囲空間（管路、ダクト系）での水素燃焼試験の条件を示している。爆轟が発生するのは、過去の試験等では、下表のような細長い配管類に水素と支燃性ガスがドライに近い条件で閉じ込められた場合であり、ダクト・配管以外の広い空間での火炎伝播試験の体系では、水素濃度が13~15%（ドライ水素濃度）でも、爆轟は発生していない。ウェット条件になるとさらに高濃度の水素でも発生していない。</p> <p>また、過去の細長い体系（管路、ダクト）での水素燃焼試験結果と再循環ダクトの体系の比較を表2に示す。</p> <p>RUT試験から、約11%未満の水素濃度では、障害物の有無に係らず、爆燃止まりであるのに対して、12.5%以上の水素濃度では障害物がある場合にのみ爆轟が発生している。</p> <p>労働省産業安全研究所の試験では、両端又は片端が閉の場合には、障害物の有無に係らず爆轟が発生している。この結果から、両端又は片端が閉の場合では、障害物がなくても配管の長さとの比(L/D)が大きく、30%程度の高水素濃度の場合は爆轟に転移する可能性が高いことが分かる。</p> <p>SRIの試験結果においては、両端が開放の場合でも水素濃度30%の水素濃度で障害物がある場合に爆轟が発生している。この結果から、配管の両端が開口の場合でも、L/Dが大きく、30%程度の高水素濃度で障害物がある場合には、爆轟が発生する可能性があることが分かる。</p> <p>NUPECの大規模試験は、内径8mの球体系(270m<sup>3</sup>)で多区画(11区画)である特徴があり、この球体系の中に円周約16m、口径1mのドーナツ状八角形空間があるが、15%（ドライ）大気圧の条件でも爆轟は発生していない。この結果から、複数の開口部があり、L/Dが20未満と比較的小さい体系では、15%程度の水素濃度でも爆轟は発生しない傾向にあることが分かる。</p> <p>以上を整理すると、爆轟発生条件として、以下の条件が挙げられる。</p> <ul style="list-style-type: none"> <li>✓ 水素濃度が12.5%未満では障害物の存在に依存しないが、12.5%以上では水素濃度と共に障害物が存在した方が爆轟の可能性が高まる。</li> <li>✓ 配管の両端が開口の場合でも、L/Dが大きく、30%程度の高水素濃度で障害物がある場合には、爆轟が発生する可能性がある。</li> <li>✓ 両端又は片端が閉の場合では、障害物がなくてもL/Dが大きく、30%程度の高水素濃度の場合に爆轟に転移する可能性が高い。</li> <li>✓ L/Dが20未満と比較的小さい体系では、15%程度の水素濃度でも爆轟は発生していない。</li> </ul> <p>実機での細長い体系である再循環ダクトでは、保守的に水蒸気凝縮による水素濃度増加を考慮し、GOTHIC解析のCVドライ平均水素濃度の最大値を包絡する値として、ダクト内の水素濃度を保守的に13%とした場合においても、開放された系であり、ダクト内には障害物がない。また、L/Dも10未満であり、過去の爆轟事例のいずれの条件にも当てはまらない。</p>	

第50条 原子炉格納容器の過圧破損を防止するための設備

赤字：設備、運用又は体制の相違（設計方針の相違）  
 青字：記載箇所又は記載内容の相違（記載方針の相違）  
 緑字：記載表現、設備名称の相違（実質的な相違なし）

大飯発電所3/4号炉

泊発電所3号炉

相違理由

表1 過去の水素燃焼に関する試験等の取組

■ 開放空間またはXYZの寸法が同等の閉空間での水素燃焼試験の条件の整理 (爆轟が生じた試験結果のみ) :

試験	試験体系	障害物の有無	水素濃度等	配管の長さ (L) と径 (D) の比 (L/D)	爆轟の発生の有無	備考
NTS試験 (米) EPRI	半径10mの球体系(2100m <sup>3</sup> ) 特徴：広い自由空間	なし	5~13vol% (水蒸気濃度4~40vol%)	該当なし	なし	
BMC (米)	640m <sup>3</sup> 特徴：多区画	なし	5.9~14vol% (水蒸気濃度0~60vol%)	該当なし	なし	
NUPEC 小規模試験	閉空間 (5m <sup>3</sup> の小体系)	なし	6.8, 10 vol% (17%) 5.50vol% (13%) 30vol% (75%)	約2.3	なし	
NUPEC 大規模試験	内径8mの球体系(270m <sup>3</sup> ) 特徴：多区画 (11区画) 円筒約16m、口径1mのドーナツ状8角形空間	手すり状の欄干もある オリフィス4箇所	5~15vol% (17%) 8~13vol% (17%)	該当なし 約16	なし	2箇所の上部区画への開口部あり 100%水素高圧(40MPa)で貯蔵のために備えられた設置し、大気への放出後に着火。
NEDO試験	100%水素高圧(40MPa)貯蔵 貯蔵のために備えられた設置し、大気への放出後に着火	なし	20~57vol% 30vol%(17%)	該当なし	なし	爆轟が発生しなかった条件等 水蒸気15vol%の条件では、同一体系でも爆轟は発生せず。 同一体系に、ベントによる開放のバスを追加した試験では爆轟は発生せず。 貯蔵物無しでは爆轟発生せず。 管の両端部とも閉の場合は爆轟は発生せず。(貯蔵物設置の場合も)

・爆轟が発生するのは、過去の試験等では、下表のような長い配管類に本素と可燃性ガスがドライに近い条件で閉じ込められた場合であり、上述のようなそれぞれ以外の体系では、ドライ濃度13.14, 15%でもそれぞれ爆轟は発生しない。  
 ■ 細長い閉空間 (管路、ダクト系) での水素燃焼試験の条件の整理 (爆轟が発生した (生じた) 結果を含む) :

試験	試験体系	障害物の有無	水素濃度等	配管の長さ (L) と径 (D) の比 (L/D)	爆轟の発生の有無	備考
RUT試験 (米) ORCDDEU	70mの閉空間 (480m <sup>3</sup> ) (2.3mW×2.5mH×70m)	12ヶ設置	~60vol% (17%) (17%)条件でも実施	約28	あり	爆轟が発生しなかった条件等 水蒸気15vol%の条件では、同一体系でも爆轟は発生せず。 同一体系に、ベントによる開放のバスを追加した試験では爆轟は発生せず。 貯蔵物無しでは爆轟発生せず。 管の両端部とも閉の場合は爆轟は発生せず。(貯蔵物設置の場合も)
NUPEC (米&米) 高温燃焼試験	爆轟管：2体系、両端部とも閉鎖構造 ・10cm内径×6.1m (SSDA試験) ・27cm内径×21.3m (HTCF試験)	貯蔵物(17%)を多数設置	約5~約50vol% (水蒸気濃度、水蒸気/本素/空気系)	SSDA試験：約60 HTCF試験：約78	あり	爆轟が発生しなかった条件等 水蒸気15vol%の条件では、同一体系でも爆轟は発生せず。 同一体系に、ベントによる開放のバスを追加した試験では爆轟は発生せず。 貯蔵物無しでは爆轟発生せず。 管の両端部とも閉の場合は爆轟は発生せず。(貯蔵物設置の場合も)
SHINEDO We-NeO	約10mの爆轟管、一端は閉鎖構造	貯蔵物有り(7.13, 25%) 60ヶの両端部	20~57vol% 30vol%(17%)	約26 約75~325	あり	爆轟が発生しなかった条件等 水蒸気15vol%の条件では、同一体系でも爆轟は発生せず。 同一体系に、ベントによる開放のバスを追加した試験では爆轟は発生せず。 貯蔵物無しでは爆轟発生せず。 管の両端部とも閉の場合は爆轟は発生せず。(貯蔵物設置の場合も)

表1 過去の水素燃焼に関する試験等の取組

■ 開放空間またはXYZの寸法が同等の閉空間での水素燃焼試験の条件の整理 (爆轟が生じた試験結果のみ) :

試験	試験体系	障害物の有無	水素濃度等	配管の長さ (L) と径 (D) の比 (L/D)	爆轟の発生の有無	備考
NTS試験 (米) EPRI	半径10mの球体系(2100m <sup>3</sup> ) 特徴：広い自由空間	なし	5~13vol% (水蒸気濃度4~40vol%)	該当なし	なし	
BMC (米)	640m <sup>3</sup> 特徴：多区画	なし	5.5~14vol% (水蒸気濃度0~60vol%)	該当なし	なし	
NUPEC 小規模試験	閉空間 (5m <sup>3</sup> の小体系)	なし	6.8, 10 vol% (17%) 5.50vol% (13%) 30vol% (75%)	約2.3	なし	
NUPEC 大規模試験	内径8mの球体系(270m <sup>3</sup> ) 特徴：多区画 (11区画) 円筒約16m、口径1mのドーナツ状8角形空間	手すり状の欄干もある オリフィス4箇所	5~15vol% (17%) 8~13vol% (17%)	該当なし 約16	なし	2箇所の上部区画への開口部あり 100%水素高圧(40MPa)で貯蔵のために備えられた設置し、大気への放出後に着火。
NEDO試験	100%水素高圧(40MPa)貯蔵 貯蔵のために備えられた設置し、大気への放出後に着火	なし	20~57vol% 30vol%(17%)	該当なし	なし	爆轟が発生しなかった条件等 水蒸気15vol%の条件では、同一体系でも爆轟は発生せず。 同一体系に、ベントによる開放のバスを追加した試験では爆轟は発生せず。 貯蔵物無しでは爆轟発生せず。 管の両端部とも閉の場合は爆轟は発生せず。(貯蔵物設置の場合も)

・爆轟が発生するのは、過去の試験等では、下表のような長い配管類に本素と可燃性ガスがドライに近い条件で閉じ込められた場合であり、上述のようなそれぞれ以外の体系では、ドライ濃度13.14, 15%でもそれぞれ爆轟は発生しない。  
 ■ ウェット条件になるように高濃度の水素でも生じていない。

表1 過去の水素燃焼に関する試験等の取組

■ 細長い閉空間 (管路、ダクト系) での水素燃焼試験の条件の整理 (爆轟が発生した (生じた) 結果を含む) :

試験	試験体系	障害物の有無	水素濃度等	配管の長さ (L) と径 (D) の比 (L/D)	爆轟の発生の有無	備考
RUT試験 (米) ORCDDEU	70mの閉空間 (480m <sup>3</sup> ) (2.3mW×2.5mH×70m)	12ヶ設置	~60vol% (17%) (17%)条件でも実施	約28	あり	爆轟が発生しなかった条件等 水蒸気15vol%の条件では、同一体系でも爆轟は発生せず。 同一体系に、ベントによる開放のバスを追加した試験では爆轟は発生せず。 貯蔵物無しでは爆轟発生せず。 管の両端部とも閉の場合は爆轟は発生せず。(貯蔵物設置の場合も)
NUPEC(米&米) 高温燃焼試験	爆轟管：2体系、両端部とも閉鎖構造 ・10cm内径×6.1m (SSDA試験) ・27cm内径×21.3m (HTCF試験)	貯蔵物(17%)を多数設置	約5~約50vol% (水蒸気濃度、水蒸気/本素/空気系)	SSDA試験：約60 HTCF試験：約78	あり	爆轟が発生しなかった条件等 水蒸気15vol%の条件では、同一体系でも爆轟は発生せず。 同一体系に、ベントによる開放のバスを追加した試験では爆轟は発生せず。 貯蔵物無しでは爆轟発生せず。 管の両端部とも閉の場合は爆轟は発生せず。(貯蔵物設置の場合も)
SRI (INEDO We-NeO)	約10mの爆轟管、一端は閉鎖構造	貯蔵物有り(7.13, 25%) 60ヶの両端部	20~57vol% 30vol%(17%)	約26 約75~325	あり	爆轟が発生しなかった条件等 水蒸気15vol%の条件では、同一体系でも爆轟は発生せず。 同一体系に、ベントによる開放のバスを追加した試験では爆轟は発生せず。 貯蔵物無しでは爆轟発生せず。 管の両端部とも閉の場合は爆轟は発生せず。(貯蔵物設置の場合も)

赤字：設備、運用又は体制の相違（設計方針の相違）  
 青字：記載箇所又は記載内容の相違（記載方針の相違）  
 緑字：記載表現、設備名称の相違（実質的な相違なし）

大飯発電所3/4号炉

泊発電所3号炉

相違理由

表2 細長い体系（管路、ダクト）での水蒸気試験結果の分析

主な試験条件、体系	水蒸気度(%)	降着物(質量率)	細長い体系	L/D(長さ/径)	試験発生の有無
RUT試験 水蒸気度：9.8～14% (17分) 長さ：9.9m 断面：2.5m×2.2m 【試験方法】 降着物：12ヶ所測定	○：9.8	●：多量付着(30%) ○：なし	●：両端閉 ○：両端開	●：20以上 ○：20未満	●：発生 ○：未発生
	○：11.2	●：30%(閉塞率)	●：両端閉	●：25	○
	○：12.5	●：49%	●：両端閉	●：25	○
	○：12.5	●：30%	●：両端閉	●：25	○
	○：12.5	●：49%	●：両端閉	●：25	○
	●：14	○	●：両端閉	●：25	○
	●：20	○	○	●：75～200	○
	●：30	○	○	●：25	○
	●：30	○	○	●：25	○
	●：30	○	○	●：25	○
	●：30	○	○	●：25	○
	●：30	○	○	●：25	○
	●：30	○	○	●：25	○
	●：30	○	○	●：25	○
SRU プロジェクト試験 水蒸気度：20～67% 長さ：9.9m 断面：0.381m×0.381m 【試験方法】 降着物：最大25個	●：20	○	●：片端閉(点水側) ○：片端開(点水側)	●：25	○
	●：20	○	●：片端閉(点水側) ○：片端開(点水側)	●：25	○
	●：20	○	●：片端閉(点水側) ○：片端開(点水側)	●：25	○
	●：20	○	●：片端閉(点水側) ○：片端開(点水側)	●：25	○
	●：20	○	●：片端閉(点水側) ○：片端開(点水側)	●：25	○
	●：20	○	●：片端閉(点水側) ○：片端開(点水側)	●：25	○
	●：20	○	●：片端閉(点水側) ○：片端開(点水側)	●：25	○
	●：20	○	●：片端閉(点水側) ○：片端開(点水側)	●：25	○
	●：20	○	●：片端閉(点水側) ○：片端開(点水側)	●：25	○
	●：20	○	●：片端閉(点水側) ○：片端開(点水側)	●：25	○
	●：20	○	●：片端閉(点水側) ○：片端開(点水側)	●：25	○
	●：20	○	●：片端閉(点水側) ○：片端開(点水側)	●：25	○
	●：20	○	●：片端閉(点水側) ○：片端開(点水側)	●：25	○
	●：20	○	●：片端閉(点水側) ○：片端開(点水側)	●：25	○
NUPEC 大規模試験 一般部 D=27mm角形状 L：21～9.1m D：0.028m 【試験方法】 降着物：多数	○：8	○	○	○	○
	○：18	○	○	○	○
	○：18	○	○	○	○
	○：18	○	○	○	○
	○：18	○	○	○	○
	○：18	○	○	○	○
	○：18	○	○	○	○
	○：18	○	○	○	○
	○：18	○	○	○	○
	○：18	○	○	○	○
	○：18	○	○	○	○
	○：18	○	○	○	○
	○：18	○	○	○	○
	○：18	○	○	○	○
CV 評価用ダクト の条件	●：13*	○	○	○	○

水蒸気度13vol%より上の試験で 降着物なしであった試験 …… 降着物なしの条件がすべてに共通、水蒸気度は14～67%。  
 上記以外の降着物なしの試験 …… 他の条件がすべて厳しい場合(90%、端閉閉、L/D大)のみ降着物発生

表2 細長い体系（管路、ダクト）での水蒸気試験結果の分析

主な試験条件、体系	水蒸気度(%)	降着物(質量率)	細長い体系	L/D(長さ/径)	試験発生の有無
RUT試験 水蒸気度：9.8～14% (17分) 長さ：9.9m 断面：2.5m×2.2m 【試験方法】 降着物：12ヶ所測定	○：9.8	●：多量付着(30%) ○：なし	●：両端閉 ○：両端開	●：20以上 ○：20未満	●：発生 ○：未発生
	○：11.2	●：30%(閉塞率)	●：両端閉	●：25	○
	○：12.5	●：49%	●：両端閉	●：25	○
	○：12.5	●：30%	●：両端閉	●：25	○
	○：12.5	●：49%	●：両端閉	●：25	○
	●：14	○	●：両端閉	●：25	○
	●：20	○	○	●：75～225	○
	●：30	○	○	●：25	○
	●：30	○	○	●：25	○
	●：30	○	○	●：25	○
	●：30	○	○	●：25	○
	●：30	○	○	●：25	○
	●：30	○	○	●：25	○
	●：30	○	○	●：25	○
NUPEC 大規模試験 一般部 D=27mm角形状 L：21～9.1m D：0.028m 【試験方法】 降着物：多数	○：8	○	○	○	○
	○：18	○	○	○	○
	○：18	○	○	○	○
	○：18	○	○	○	○
	○：18	○	○	○	○
	○：18	○	○	○	○
	○：18	○	○	○	○
	○：18	○	○	○	○
	○：18	○	○	○	○
	○：18	○	○	○	○
	○：18	○	○	○	○
	○：18	○	○	○	○
	○：18	○	○	○	○
	○：18	○	○	○	○
CV 評価用ダクト の条件	●：13*	○	○	○	○

水蒸気度13vol%より上の試験で 降着物なしであった試験 …… 降着物なしの条件がすべてに共通、水蒸気度は14～57%。  
 上記以外の降着物なしの試験 …… 他の条件がすべて厳しい場合(90%、端閉閉、L/D大)のみ降着物発生



赤字：設備、運用又は体制の相違（設計方針の相違）  
 青字：記載箇所又は記載内容の相違（記載方針の相違）  
 緑字：記載表現、設備名称の相違（実質的な相違なし）

第50条 原子炉格納容器の過圧破損を防止するための設備

大飯発電所3/4号炉	泊発電所3号炉	相違理由																						
<p>参考資料-4 再循環ユニットによる自然対流冷却時の沸騰防止運用について</p> <p>1. はじめに                      原子炉冷却材喪失事故（LOCA）+全交流電源喪失（SBO）+最終ヒートシンク喪失（LUHS）の事象を想定するような重大事故発生時において、格納容器の自然対流冷却を実施するための大容量ポンプによる再循環ユニット通水時における沸騰防止運用について纏めた。本資料では、より条件の厳しい大飯4号機について述べる。</p> <p>2. 格納容器再循環ユニットへの通水流体の沸騰防止運用の成立性について                      (1) 検討内容                      大容量ポンプを用いて格納容器再循環ユニットに通水する際に格納容器再循環ユニット出口における沸騰を防止することが成立することを確認する。                      (2) 検討                      格納容器温度が最高となる格納容器過温破損（全交流動力電源喪失+補助給水失敗）における格納容器雰囲気温度の最高値は約144℃であり、格納容器再循環ユニット内部における流体条件を保守的に格納容器雰囲気温度と同等である約144℃とした場合の飽和蒸気圧は約0.31MPa(gage)となる。</p> <p>この場合、再循環ユニットへの通水ラインの静水頭差、ライン圧力損失等の合計は、下表のとおり [ ] である。これに対して、大容量ポンプの吐出圧力は、 [ ] 以上としている。</p> <table border="1" data-bbox="280 901 913 1061"> <thead> <tr> <th>項目</th> <th>圧力損失(MPa)</th> </tr> </thead> <tbody> <tr> <td>ライン損失(大容量ポンプ～格納容器再循環ユニット出口)</td> <td>[ ]</td> </tr> <tr> <td>静水頭差(大容量ポンプ～格納容器再循環ユニット)</td> <td>[ ]</td> </tr> <tr> <td>再循環ユニット出口背圧確保(沸騰防止)</td> <td>0.31(*)</td> </tr> <tr> <td>合計</td> <td>[ ]</td> </tr> </tbody> </table> <p>*：保守的に重大事故シナシ「格納容器過温破損（全交流動力電源喪失+補助給水失敗）」における格納容器雰囲気温度を基に設定                      注：大容量ポンプをEL.9.3mに設置し通水した場合の評価</p> <p>[ ] 枠囲みの範囲は機密に係る事項ですので公開することができません。</p>	項目	圧力損失(MPa)	ライン損失(大容量ポンプ～格納容器再循環ユニット出口)	[ ]	静水頭差(大容量ポンプ～格納容器再循環ユニット)	[ ]	再循環ユニット出口背圧確保(沸騰防止)	0.31(*)	合計	[ ]	<p>参考資料-4 格納容器再循環ユニットによる自然対流冷却時の沸騰防止運用について</p> <p>1. はじめに                      原子炉冷却材喪失事故（LOCA）+全交流動力電源喪失（SBO）+最終ヒートシンク喪失（LUHS）の事象を想定するような重大事故発生時において、格納容器の自然対流冷却を実施するために可搬型大型送水ポンプ車による格納容器再循環ユニット通水時における沸騰防止運用について纏めた。</p> <p>2. 格納容器再循環ユニットへの通水流体の沸騰防止運用の成立性について                      (1) 検討内容                      可搬型大型送水ポンプ車を用いて格納容器再循環ユニットに通水する際に格納容器再循環ユニット出口における沸騰を防止することが成立することを確認する。                      (2) 検討                      格納容器温度が最高となる格納容器過温破損（全交流動力電源喪失+補助給水失敗）における格納容器雰囲気温度の最高値は約141℃であり、格納容器再循環ユニット内部における流体条件を保守的に格納容器雰囲気温度と同等である141℃とした場合の飽和蒸気圧は0.272MPa(gage) [約28m]となる。</p> <p>この場合、格納容器再循環ユニットへの通水ラインの静水頭差、ライン圧力損失等の合計は、下表のとおり [ ] mである。これに対して、可搬型大型送水ポンプ車の吐出圧力は、 [ ] m以上としている。</p> <table border="1" data-bbox="1097 869 1915 1189"> <thead> <tr> <th>項目</th> <th>必要揚程</th> </tr> </thead> <tbody> <tr> <td>機器圧損 (可搬型大型送水ポンプ車～格納容器再循環ユニット出口)</td> <td>[ ] m</td> </tr> <tr> <td>配管・ホース及び弁類圧損 (可搬型大型送水ポンプ車～格納容器再循環ユニット出口)</td> <td>[ ] m</td> </tr> <tr> <td>静水頭差(可搬型大型送水ポンプ車～格納容器再循環ユニット)</td> <td>[ ] m</td> </tr> <tr> <td>取水源と移送先の圧力差 (沸騰防止のための格納容器再循環ユニット出口保持圧力)</td> <td>約28m*</td> </tr> <tr> <td>合計</td> <td>[ ]</td> </tr> </tbody> </table> <p>* 保守的に重大事故シナシ「格納容器過温破損（全交流動力電源喪失+補助給水失敗）」における格納容器雰囲気温度を基に設定                      注 可搬型大型送水ポンプ車を T.P. 10m（ポンプ吸込位置（T.P. 11. 25m））に設置し、通水した場合の評価。</p> <p>[ ] 枠囲みの内容は機密情報に属しますので公開できません。</p>	項目	必要揚程	機器圧損 (可搬型大型送水ポンプ車～格納容器再循環ユニット出口)	[ ] m	配管・ホース及び弁類圧損 (可搬型大型送水ポンプ車～格納容器再循環ユニット出口)	[ ] m	静水頭差(可搬型大型送水ポンプ車～格納容器再循環ユニット)	[ ] m	取水源と移送先の圧力差 (沸騰防止のための格納容器再循環ユニット出口保持圧力)	約28m*	合計	[ ]	<p>設備名称の相違</p> <p>解析結果の相違                      ・解析結果は相違するが、格納容器の最高温度の飽和蒸気圧を背圧として考慮する方針は同じである。</p> <p>設計の相違                      ・配置設計の相違による圧力損失は相違しているが、必要揚程（圧力損失）を算出の方法は同じである。</p>
項目	圧力損失(MPa)																							
ライン損失(大容量ポンプ～格納容器再循環ユニット出口)	[ ]																							
静水頭差(大容量ポンプ～格納容器再循環ユニット)	[ ]																							
再循環ユニット出口背圧確保(沸騰防止)	0.31(*)																							
合計	[ ]																							
項目	必要揚程																							
機器圧損 (可搬型大型送水ポンプ車～格納容器再循環ユニット出口)	[ ] m																							
配管・ホース及び弁類圧損 (可搬型大型送水ポンプ車～格納容器再循環ユニット出口)	[ ] m																							
静水頭差(可搬型大型送水ポンプ車～格納容器再循環ユニット)	[ ] m																							
取水源と移送先の圧力差 (沸騰防止のための格納容器再循環ユニット出口保持圧力)	約28m*																							
合計	[ ]																							

赤字：設備、運用又は体制の相違（設計方針の相違）  
 青字：記載箇所又は記載内容の相違（記載方針の相違）  
 緑字：記載表現、設備名称の相違（実質的な相違なし）

第50条 原子炉格納容器の過圧破損を防止するための設備

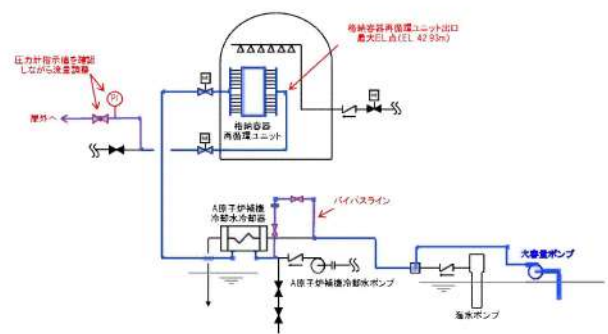
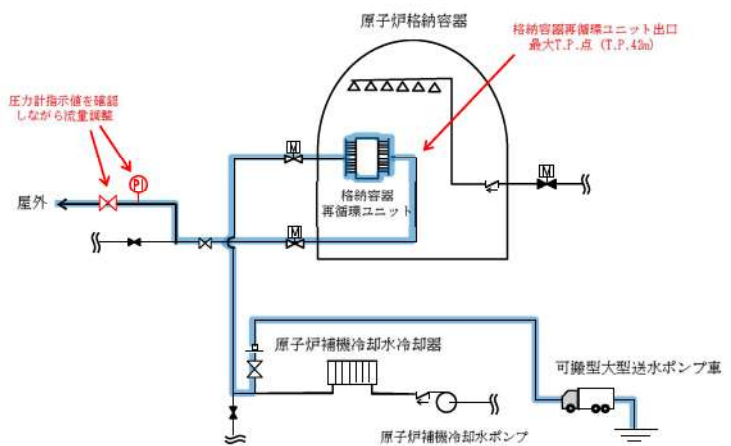
大飯発電所3/4号炉	泊発電所3号炉	相違理由
<p>(3) 検討結果</p> <p>大飯3、4号機で使用する大容量ポンプの吐出圧力は、格納容器再循環ユニットへの通水流体の沸騰防止を行うための圧力を上回っているため、この運用を行うことができる。</p> <p>なお、格納容器自然対流冷却を実施するために大容量ポンプを用いて格納容器再循環ユニットに海水を通水する際には、格納容器再循環ユニット出口圧力計（格納容器外）にて圧力を確認しながら海水排水ラインに設けられた流量調整弁（格納容器外）を操作し、格納容器再循環ユニット内での沸騰を防止する。</p> <p>【参考1】系統概念図</p>  <p>図-1 再循環ユニット冷却水配管概念図（大飯3、4号）</p>	<p>(3) 検討結果</p> <p>泊3号炉で使用する可搬型大型送水ポンプ車の吐出圧力は、格納容器再循環ユニットへの通水流体の沸騰防止を行うための圧力を上回っているため、この運用を行うことができる。</p> <p>なお、格納容器自然対流冷却を実施するために可搬型大型送水ポンプ車を用いて格納容器再循環ユニットに海水を通水する際には、格納容器再循環ユニット出口圧力計（格納容器外）にて圧力を確認しながら海水排水ラインに設けられた流量調整弁（格納容器外）を操作し、格納容器再循環ユニット内での沸騰を防止する。</p> <p>【参考1】系統概念図</p> 	<p>設備名称の相違</p>

赤字：設備、運用又は体制の相違（設計方針の相違）  
 青字：記載箇所又は記載内容の相違（記載方針の相違）  
 緑字：記載表現、設備名称の相違（実質的な相違なし）

第50条 原子炉格納容器の過圧破損を防止するための設備

大飯発電所3 / 4号炉	泊発電所3号炉	相違理由
<p>参考資料-5 OECD PANDA 試験の知見を踏まえた自然対流冷却に関する考察</p> <p>1. はじめに                      本資料は、OECD で実施された PANDA 試験における格納容器クーラに関する試験を踏まえて、格納容器再循環ユニットの除熱性能への影響を考察したものである。</p> <p>2. OECD PANDA 試験における格納容器クーラ試験                      (1) 格納容器クーラ試験の概要                      PANDA 試験における格納容器クーラに関する試験 (ST4) は、原子炉格納容器内で水素成層化したことを前提として、軽い不凝縮性ガス (実機：水素、PANDA 試験：ヘリウム) によるクーラの除熱性能への影響を評価したものである。</p> <p>(2) 試験内容                      試験は以下のように試験容器内中央部からの注入ガス成分を変化させ、以下の3フェーズにより実施している。                      ・フェーズⅠ：水蒸気注入 (図 1a、2a)                      ・フェーズⅡ：水蒸気-ヘリウム混合ガスの注入 (図 1b~e、図 2b~e)                      ・フェーズⅢ：水蒸気注入 (図 1f、2f)</p> <p>(3) 試験条件                      PANDA 試験では、感度ケースとして以下の条件を考慮している。                      ・格納容器クーラの設置高さ                      (基本ケース：容器中央、感度ケース：容器上部)                      ・容器からのベント (加圧状態による影響の確認)                      ・クーラ下部のダクト開口部閉止</p> <p>(4) 試験結果概要                      基本ケース (クーラを容器中央設置 (図 1a~f)) では、フェーズⅡ (水蒸気-ヘリウム混合ガスを注入する段階) において、ヘリウム濃度が高いガスがクーラケーシング内に蓄積することで、(図 1b) の段階ですでに排気ダクトを通る下降流がなくなっており、クーラ内部にヘリウム濃度が高まったガスが成層化して蓄積することにより約20%のクーラ除熱性能低下が見られた (図 1c)。また、蓄積したガスがクーラ入口付近から逆に放出され、容器内の密度成層化を形成している (図 1e、f)                      一方、感度ケース (クーラを容器上部設置 (図 2a~f)) では、フェーズⅡにおいてクーラケーシング内へのヘリウムの蓄積が観察されたが、基本ケースと比べてより小さな範囲に留まった。このため、除熱性能の低下は基本ケースと比べて限定的であった。</p>	<p>参考資料-5 OECD PANDA 試験の知見を踏まえた自然対流冷却に関する考察</p> <p>1. はじめに                      本資料は、OECD で実施された PANDA 試験における格納容器クーラに関する試験を踏まえて、格納容器再循環ユニットの除熱性能への影響を考察したものである。</p> <p>2. OECD PANDA 試験における格納容器クーラ試験                      (1) 格納容器クーラ試験の概要                      PANDA 試験における格納容器クーラに関する試験 (ST4) は、原子炉格納容器内で水素成層化したことを前提として、軽い不凝縮性ガス (実機：水素、PANDA 試験：ヘリウム) によるクーラの除熱性能への影響を評価したものである。</p> <p>(2) 試験内容                      試験は以下のように試験容器内中央部からの注入ガス成分を変化させ、以下の3フェーズにより実施している。                      ・フェーズⅠ：水蒸気注入 (図 1a、2a)                      ・フェーズⅡ：水蒸気-ヘリウム混合ガスの注入 (図 1b~e、図 2b~e)                      ・フェーズⅢ：水蒸気注入 (図 1f、2f)</p> <p>(3) 試験条件                      PANDA 試験では、感度ケースとして以下の条件を考慮している。                      ・格納容器クーラの設置高さ                      (基本ケース：容器中央、感度ケース：容器上部)                      ・容器からのベント (加圧状態による影響の確認)                      ・クーラ下部のダクト開口部閉止</p> <p>(4) 試験結果概要                      基本ケース (クーラを容器中央設置 (図 1a~f)) では、フェーズⅡ (水蒸気-ヘリウム混合ガスを注入する段階) において、ヘリウム濃度が高いガスがクーラケーシング内に蓄積することで、(図 1b) の段階ですでに排気ダクトを通る下降流がなくなっており、クーラ内部にヘリウム濃度が高まったガスが成層化して蓄積することにより約20%のクーラ除熱性能低下が見られた (図 1c)。また、蓄積したガスがクーラ入口付近から逆に放出され、容器内の密度成層化を形成している (図 1e、f)                      一方、感度ケース (クーラを容器上部設置 (図 2a~f)) では、フェーズⅡにおいてクーラケーシング内へのヘリウムの蓄積が観察されたが、基本ケースと比べてより小さな範囲に留まった。このため、除熱性能の低下は基本ケースと比べて限定的であった。</p>	

赤字：設備、運用又は体制の相違（設計方針の相違）  
 青字：記載箇所又は記載内容の相違（記載方針の相違）  
 緑字：記載表現、設備名称の相違（実質的な相違なし）

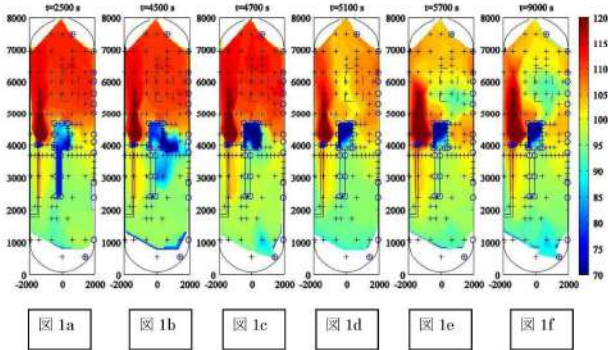
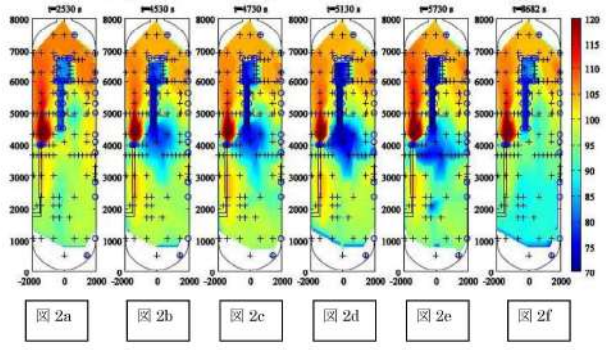
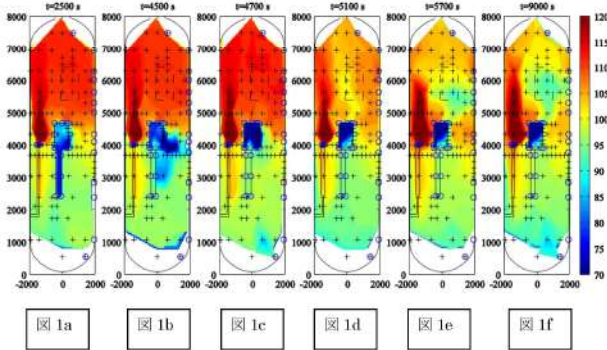
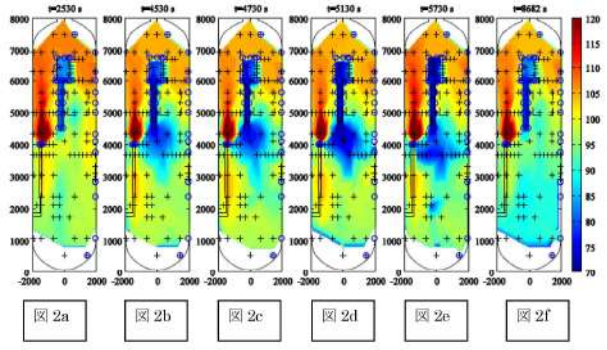
大飯発電所 3 / 4 号炉	泊発電所 3 号炉	相違理由
<p>Figure 40. Temperature Contour Map for the Test with the Cooler at the Middle Position</p>  <p>Figure 41. Temperature Contour Map for the Test with the Cooler at the Top Position</p>  <p>3. PANDA 試験結果を踏まえた考察              上記の結果を踏まえ、PANDA 試験結果と実機 PWR プラントにおける格納容器内成層化による格納容器クーラ除熱性能の考察を表 1 にまとめる。</p>	<p>Figure 40. Temperature Contour Map for the Test with the Cooler at the Middle Position</p>  <p>Figure 41. Temperature Contour Map for the Test with the Cooler at the Top Position</p>  <p>3. PANDA 試験結果を踏まえた考察              上記の結果を踏まえ、PANDA 試験結果と実機 PWR プラントにおける格納容器内成層化による格納容器クーラ除熱性能の考察を表 1 にまとめる。</p>	



赤字：設備、運用又は体制の相違（設計方針の相違）  
 青字：記載箇所又は記載内容の相違（記載方針の相違）  
 緑字：記載表現、設備名称の相違（実質的な相違なし）

第50条 原子炉格納容器の過圧破損を防止するための設備

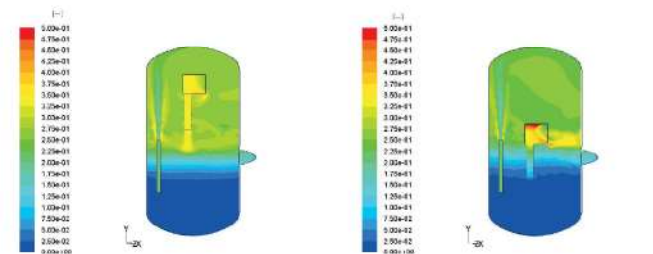
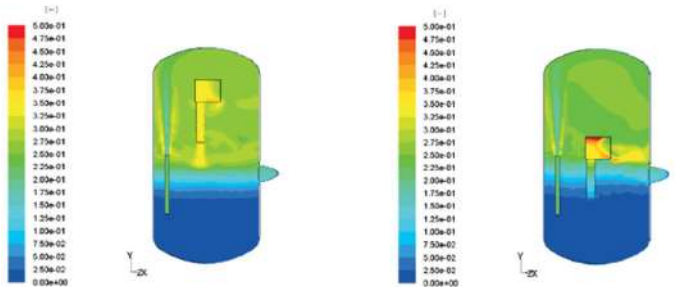
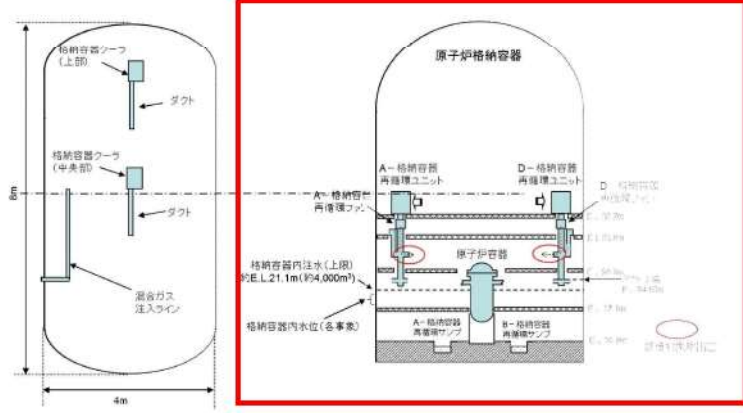
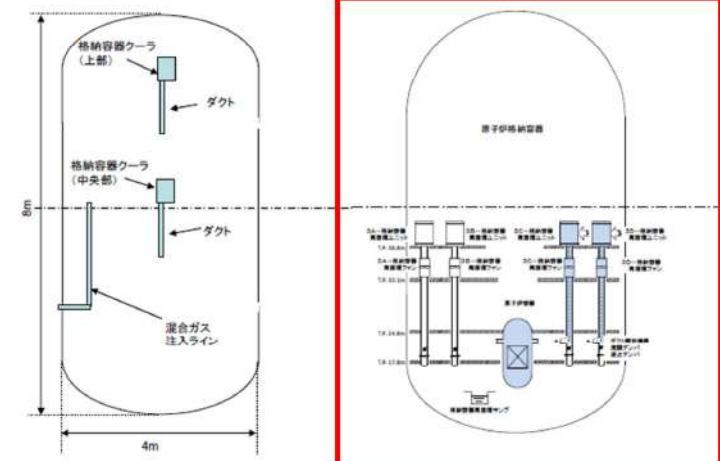
大飯発電所3 / 4号炉	泊発電所3号炉	相違理由
 <p>図3-48 ST4-1試験 DW1ヘリウムモル分率 (2,000秒, Phase2)</p> <p>図3-49 ST4-2試験 DW1ヘリウムモル分率 (2,000秒, Phase2)</p> <p>(1) 格納容器上部 (2) 格納容器中央部</p> <p>図3 注入ラインとクーラを含む断面におけるフェーズII(2,000秒後)のヘリウムモル分率          (出典：平成21年度 シビアアクシデント時格納容器内多次元熱流動及びFP挙動解析、平成22年6月、独立行政法人 原子力安全基盤機構)</p>	 <p>図3-48 ST4-1試験 DW1ヘリウムモル分率 (2,000秒, Phase2)</p> <p>図3-49 ST4-2試験 DW1ヘリウムモル分率 (2,000秒, Phase2)</p> <p>(1) 格納容器上部 (2) 格納容器中央部</p> <p>図3 注入ラインとクーラを含む断面におけるフェーズII(2,000秒後)のヘリウムモル分率          (出典：平成21年度 シビアアクシデント時格納容器内多次元熱流動及びFP挙動解析、平成22年6月、独立行政法人 原子力安全基盤機構)</p>	
 <p>図4 PANDAと原子炉格納容器(大飯3、4号機の例)との設備位置の相対位置比較</p>	 <p>図4 PANDAと原子炉格納容器(泊3号炉の例)との設備位置の相対位置比較</p>	<p>設計の相違</p>

赤字：設備、運用又は体制の相違（設計方針の相違）  
 青字：記載箇所又は記載内容の相違（記載方針の相違）  
 緑字：記載表現、設備名称の相違（実質的な相違なし）

第50条 原子炉格納容器の過圧破損を防止するための設備

大飯発電所3/4号炉	泊発電所3号炉	相違理由
<p>参考資料-6 格納容器再循環ユニットによる格納容器内自然対流冷却の水素影響について</p> <p>1. はじめに</p> <p>原子炉格納容器内に水素が存在する場合に、格納容器再循環ユニットの除熱性能は水素濃度に応じて変化するため、不確かさが存在する。このため、格納容器破損防止の観点で、ドライ換算で13vol%の水素が原子炉格納容器内に存在する場合の感度解析を実施し、原子炉格納容器圧力及び温度に対する影響を確認した。</p> <p>2. 影響評価</p> <p>格納容器破損モード「雰囲気圧力・温度による静的負荷(格納容器過圧破損)」の評価事故シーケンス「大破断LOCA時に低圧注入機能、高圧注入機能及び格納容器スプレイ機能が喪失する事故」における原子炉格納容器圧力及び温度の推移をそれぞれ図1及び図2に示す。</p> <p>ドライ換算で13vol%の水素が原子炉格納容器内に存在する場合、原子炉格納容器圧力は格納容器再循環ユニットによる格納容器内自然対流冷却開始前に最高値に到達するため、最高値に関して格納容器内自然対流冷却の水素濃度の影響はない。その後の格納容器内自然対流冷却開始後においては、水素濃度の影響を考慮しても、格納容器内自然対流冷却により原子炉格納容器圧力は低下傾向となっており、原子炉格納容器最高使用圧力の2倍(0.78MPa[gage])に対して十分余裕がある。また、原子炉格納容器雰囲気温度への影響は小さく、原子炉格納容器雰囲気温度200℃に対して十分余裕があるため、水素濃度による不確かさを考慮しても、評価項目となるパラメータに与える影響は小さいことを確認した。</p> <div style="border: 1px solid black; padding: 5px; margin-top: 10px;"> <p>2. 影響評価</p> <p>格納容器破損モード「雰囲気圧力・温度による静的負荷(格納容器過圧破損)」における評価事故シーケンスである「大破断LOCA時に高圧注入機能、低圧注入機能及び格納容器スプレイ機能が喪失する事故」の場合の原子炉格納容器圧力及び温度の推移をそれぞれ図1及び図2に示す。</p> <p>最大限水素が発生した状態(評価項目であるドライ換算水素濃度13%)では、原子炉格納容器圧力を約0.016MPa、原子炉格納容器雰囲気温度を約2℃高く評価するが、評価項目である原子炉格納容器最高使用圧力の2倍及び原子炉格納容器雰囲気温度200℃に対して十分余裕があり、水素濃度の不確かさを考慮しても評価項目となるパラメータに与える影響は小さい。</p> </div> <div style="border: 1px solid black; padding: 5px; margin-top: 10px; text-align: center;"> <p>本記載は、伊方3号炉の参考掲載</p> </div>	<p>参考資料-6 格納容器再循環ユニットによる格納容器内自然対流冷却の水素影響について</p> <p>1. はじめに</p> <p>原子炉格納容器内に水素が存在する場合に、格納容器再循環ユニットの除熱性能は水素濃度に応じて変化するため、不確かさが存在する。このため、格納容器破損防止の観点で、ドライ換算で13vol%の水素が原子炉格納容器内に存在する場合の感度解析を実施し、原子炉格納容器圧力及び温度に対する影響を確認した。</p> <p>2. 影響評価</p> <p>格納容器破損モード「雰囲気圧力・温度による静的負荷(格納容器過圧破損)」の評価事故シーケンス「大破断LOCA時に低圧注入機能、高圧注入機能及び格納容器スプレイ機能が喪失する事故」における原子炉格納容器圧力及び温度の推移をそれぞれ図1及び図2に示す。</p> <p>ドライ換算で13vol%の水素が原子炉格納容器内に存在する場合、原子炉格納容器圧力を約0.011MPaの範囲で高めに評価し、原子炉格納容器雰囲気温度は約1℃未満の上昇幅である。評価項目である原子炉格納容器圧力及び温度は、それぞれ原子炉格納容器の最高使用圧力の2倍(0.566MPa[gage])及び200℃に対して十分な余裕があり、水素濃度による不確かさを考慮しても、評価項目となるパラメータに与える影響は小さいことを確認した。</p>	<p><b>解析結果の相違</b></p> <ul style="list-style-type: none"> <li>・大飯3/4号炉では、自然対流冷却開始前に格納容器圧力のピークを迎え、自然対流冷却により格納容器圧力が減圧されるため、水素影響を考慮しても200℃・2Pdに影響ないと評価している。</li> <li>・泊は、自然対流冷却開始後に格納容器圧力のピークを迎えた後、減圧する圧力挙動であるため、水素影響による圧力影響・温度影響を具体的に示している。(伊方と同様)</li> <li>・具体的な水素影響を考慮した数値を記載するかしないかの相違であるが、200℃・2Pdに影響するものでないことは同様である。</li> </ul> <p><b>記載表現の相違</b></p> <ul style="list-style-type: none"> <li>・泊と同じ解析挙動の伊方の記載に合せている。</li> </ul>

赤字：設備、運用又は体制の相違（設計方針の相違）  
 青字：記載箇所又は記載内容の相違（記載方針の相違）  
 緑字：記載表現、設備名称の相違（実質的な相違なし）

第50条 原子炉格納容器の過圧破損を防止するための設備

大飯発電所3 / 4号炉	泊発電所3号炉	相違理由
<div data-bbox="313 271 963 766"> <p>図1 原子炉格納容器圧力の推移                  (格納容器再循環ユニットによる格納容器内自然対流冷却の水素影響確認)</p> </div> <div data-bbox="313 861 963 1292"> <p>図2 原子炉格納容器雰囲気温度の推移                  (格納容器再循環ユニットによる格納容器内自然対流冷却の水素影響確認)</p> </div> <p style="text-align: right;">48-8-61</p>	<div data-bbox="1198 231 1848 718"> <p>図1 原子炉格納容器圧力の推移                  (格納容器再循環ユニットによる格納容器内自然対流冷却の水素影響確認)</p> </div> <div data-bbox="1198 774 1848 1228"> <p>図2 格納容器内雰囲気温度の推移                  (格納容器再循環ユニットによる格納容器内自然対流冷却の水素影響確認)</p> </div> <p style="text-align: right;">48-7-63</p>	<p>解析結果の相違</p>



赤字：設備、運用又は体制の相違（設計方針の相違）  
 青字：記載箇所又は記載内容の相違（記載方針の相違）  
 緑字：記載表現、設備名称の相違（実質的な相違なし）

第50条 原子炉格納容器の過圧破損を防止するための設備

大飯発電所3/4号炉	泊発電所3号炉	相違理由
<p>参考資料-7 実機における凝縮水の影響について</p> <p>1. はじめに 本資料は、実機における凝縮水の影響について考察を行うものである。</p> <p>2. 実機における凝縮水の影響 実機において、格納容器再循環ユニット冷却コイルの凝縮水ドレンについては、下記のような経路を通じて最終的には格納容器サンプへ流出する。図1に格納容器再循環ユニットにおける凝縮水ドレンの流路の模式図を示す。</p> <p>【凝縮水が少量の場合（通常運転時等）】 個々の冷却コイル下部に設置されているドレンパンから、ドレンラインを経由して格納容器サンプへ排出される。本ドレンラインは、通常運転時に発生する凝縮水処理機能、及び原子炉冷却材圧力バウンダリから少量の1次冷却材漏えいが発生した場合に備えて、その単位時間当たりの漏えい量を凝縮水として測定する機能を有しており、多量の凝縮水の排出を目的としたものではない。</p> <p>【凝縮水が多量の場合（重大事故時等）】 重大事故時等においては上記ドレンラインの許容排出流量を超える可能性があるが、超過分の凝縮水についてはドレンパンから溢れることになる。この場合、ユニット外側に流れた凝縮水は、ユニット設置フロアの床ドレンを通じて格納容器サンプへ排出される。一方、ユニット内側に流れた凝縮水はダクト側へ流れ、<b>ダクト下端部の吹出口からダクト外へ流れる</b>。いずれの場合についても、流出先の床ドレンを通じて格納容器サンプへ排出される。</p> <div style="border: 1px solid black; padding: 5px; margin-top: 10px;"> <p>一方、ユニット内側に流れた凝縮水はダクト側へ流れる。ダクト下方には再循環ユニットファン出口ダンパがあり、重大事故等時には閉止状態となっているので、ダンパ上部での水位が上昇した場合にはダクト開口からダクト外へ流れる。</p> </div> <div style="border: 1px solid black; padding: 5px; margin-top: 10px; text-align: center;"> <p>本記載は、伊方3号炉の参考掲載</p> </div> <p>(参考) ドレンパンは、上面から見て直下にあるコイルを十分に覆い隠す程度に広い面積を持っており、さらに、ドレンパンの底面端部はドレンパンの排水溝やサポート板の取り付けにより、端部から溢れた水がドレンパン底面を伝って下部のコイルへ直接滴下し難い構造となっているために、溢れ出した水がその下部のコイルに滴下せず速やかに排出される。また仮に、下部のコイルへ直接水が滴下した場合にもコイル上面には天板が設置されているために上部からの凝縮水の影響を防ぐことが可能である。</p>	<p>参考資料-7 実機における凝縮水の影響について</p> <p>1. はじめに 本資料は、実機における凝縮水の影響について考察を行うものである。</p> <p>2. 実機における凝縮水の影響 実機において、格納容器再循環ユニット冷却コイルの凝縮水ドレンについては、下記のような経路を通じて最終的には格納容器サンプへ流出する。図1に格納容器再循環ユニットにおける凝縮水ドレンの流路の模式図を示す。</p> <p>【凝縮水が少量の場合（通常運転時等）】 個々の冷却コイル下部に設置されているドレンパンから、ドレンラインを経由して格納容器サンプへ排出される。本ドレンラインは、通常運転時に発生する凝縮水処理機能、及び原子炉冷却材圧力バウンダリから少量の1次冷却材漏えいが発生した場合に備えて、その単位時間当たりの漏えい量を凝縮水として測定する機能を有しており、多量の凝縮水の排出を目的としたものではない。</p> <p>【凝縮水が多量の場合（重大事故時等）】 重大事故時等においては上記ドレンラインの許容排出流量を超える可能性があるが、超過分の凝縮水についてはドレンパンから溢れることになる。この場合、ユニット外側に流れた凝縮水は、ユニット設置フロアの床ドレンを通じて格納容器サンプへ排出される。一方、ユニット内側に流れた凝縮水はダクト側へ流れる。<b>ダクト下方には再循環ユニットファン出口ダンパがあり、重大事故時には閉止状態となっているので、ダンパ上部での水位が上昇した場合にはダクト開口からダクト外へ流れる</b>。いずれの場合についても、流出先の床ドレンを通じて格納容器サンプへ排出される。</p> <p>(参考) ドレンパンは、上面から見て直下にあるコイルを十分に覆い隠す程度に広い面積を持っており、さらに、ドレンパンの底面端部はドレンパンの排水溝やサポート板の取り付けにより、端部から溢れた水がドレンパン底面を伝って下部のコイルへ直接滴下し難い構造となっているために、溢れ出した水がその下部のコイルに滴下せず速やかに排出される。また仮に、下部のコイルへ直接水が滴下した場合にもコイル上面には天板が設置されているために上部からの凝縮水の影響を防ぐことが可能である。</p>	<p>相違理由</p> <p>設計方針の相違 ・再循環ダクト構成が相違するが、伊方と同様である。</p>

赤字：設備、運用又は体制の相違（設計方針の相違）  
 青字：記載箇所又は記載内容の相違（記載方針の相違）  
 緑字：記載表現、設備名称の相違（実質的な相違なし）

大飯発電所 3 / 4 号炉	泊発電所 3 号炉	相違理由
<div data-bbox="224 271 940 1173" style="border: 2px solid red; border-bottom: 2px solid black; width: 320px; height: 565px; margin: 0 auto;"></div> <div data-bbox="398 1173 797 1190" style="text-align: center; margin: 5px auto;"> <span style="margin-right: 100px;">通常運転時等</span> <span>重大事故時等</span> </div> <div data-bbox="497 1197 676 1217" style="text-align: center;"> <p>凝縮水ドレン流路模式図</p> </div> <div data-bbox="333 1227 831 1248" style="text-align: center;"> <p>図 1 格納容器再循環ユニットにおける凝縮水ドレンの流路（模式図）</p> </div> <div data-bbox="452 1305 900 1329" style="border: 1px solid black; padding: 2px; margin: 10px auto; width: fit-content;"> <p>枠囲みの範囲は機密に係る事項ですので公開することはできません。</p> </div>	<div data-bbox="1108 271 1904 1165" style="border: 2px solid red; border-bottom: 2px solid black; width: 355px; height: 560px; margin: 0 auto;"></div> <div data-bbox="1299 1165 1720 1182" style="text-align: center; margin: 5px auto;"> <span style="margin-right: 100px;">通常運転時等</span> <span>重大事故時等</span> </div> <div data-bbox="1393 1192 1576 1212" style="text-align: center;"> <p>凝縮水ドレン流路模式図</p> </div> <div data-bbox="1229 1222 1731 1243" style="text-align: center;"> <p>図 1 格納容器再循環ユニットにおける凝縮水ドレンの流路（模式図）</p> </div> <div data-bbox="1370 1321 1883 1345" style="border: 1px solid black; padding: 2px; margin: 10px auto; width: fit-content;"> <p>枠囲みの内容は機密情報に属しますので公開できません。</p> </div>	<p style="color: red;">設計方針の相違</p> <ul style="list-style-type: none"> <li style="color: red;">・再循環ユニット設計及び再循環ゲート構成の相違</li> </ul>

赤字：設備、運用又は体制の相違（設計方針の相違）  
 青字：記載箇所又は記載内容の相違（記載方針の相違）  
 緑字：記載表現、設備名称の相違（実質的な相違なし）

第50条 原子炉格納容器の過圧破損を防止するための設備

大飯発電所3/4号炉	泊発電所3号炉	相違理由
<p>参考資料-8 格納容器再循環ユニットによる自然対流冷却発生プロセスの定量的考察</p> <p>格納容器再循環ユニットによる自然対流冷却の発生概念については図4-1に示した通りであり、冷却水通水後に過渡状態を経てユニット外側から下部ダクトへの定常的な流れが発生する。自然対流冷却が確立することに関しては、参考資料-5で示した OECD PANDA における実証試験や、独立行政法人 原子力安全基盤機構（JNES）による同試験の解析による検証結果でも確認することができる。本参考資料では、JNES の解析結果を基にした自然対流冷却発生プロセスの定量的な考察を行う。</p> <p>JNES では、国のアクシデントマネジメント(AM)レビューやリスク上重要とされるシビアアクシデント(SA)現象及びAM策の有効性を評価するために、最新の試験研究等で得られた知見やデータを活用して解析ツールの整備が実施されており、数値流体力学解析手法を用いて格納容器内熱流動解析手法を整備し、試験データを用いて検証すること、さらに、代表的な格納容器AM策に適用したその有効性が評価されている。この一環として下記の2点の検討結果が報告されている。</p> <p><b>【1. PANDA 試験の試験前解析】</b></p> <p>格納容器内熱流動研究に関する OECD 国際協力プロジェクト PANDA 試験のデータを用いて格納容器内熱流動解析手法を検証するとともに、PANDA 試験の格納容器自然対流冷却試験シリーズの試験前解析を実施しており、クーラ周辺の詳細流動等のクーラ特性に係る有用な知見を得ている。</p> <p><b>【2. 実炉解析】</b></p> <p>上記で検証した解析手法を PWR 実炉の格納容器体系に適用して、SA 時に格納容器自然対流冷却を実施した場合のクーラ除熱効果や格納容器内温度分布、混合ガスの濃度分布等を評価している。解析メッシュは上記より粗いものの、格納容器自然対流冷却 AM は格納容器内雰囲気を効果的に冷却させることを確認している。</p> <p>なお、これらの内容は以下の報告書に纏められている。</p> <p>①アクシデントマネジメント知識ベース整備に関する報告書（格納容器内多次元流動解析手法の検証と自然対流冷却 AM 策への適用）(H17～H19 年度)</p> <p>②アクシデントマネジメント時格納容器内多次元熱流動及び FP 挙動解析(H20～H21 年度)</p> <p>以下では、格納容器再循環ユニットによる自然対流冷却の自然対流冷却発生プロセスについて、上記報告書に纏められたこれらの2点の検討結果に基づき、以下に定量的考察を説明する。</p> <p>1. PANDA 試験の試験前解析</p> <p>PANDA 試験の試験前解析は H17～H21 年度まで毎年実施しているが、ダクト系を模擬した再循環クーラの解析については H20 年度と H21 年度にて実施している。ここでこのうち最新の H21 年度報告書をモデルとして説明する。</p> <p>(1)解析モデルと解析条件</p>	<p>参考資料-8 格納容器再循環ユニットによる自然対流冷却発生プロセスの定量的考察</p> <p>格納容器再循環ユニットによる自然対流冷却の発生概念については図4-1に示した通りであり、冷却水通水後に過渡状態を経てユニット外側から下部ダクトへの定常的な流れが発生する。自然対流冷却が確立することに関しては、参考資料-5で示した OECD PANDA における実証試験や、独立行政法人 原子力安全基盤機構（JNES）による同試験の解析による検証結果でも確認することができる。本参考資料では、JNES の解析結果を基にした自然対流冷却発生プロセスの定量的な考察を行う。</p> <p>JNES では、国のアクシデントマネジメント(AM)レビューやリスク上重要とされるシビアアクシデント(SA)現象及びAM策の有効性を評価するために、最新の試験研究等で得られた知見やデータを活用して解析ツールの整備が実施されており、数値流体力学解析手法を用いて格納容器内熱流動解析手法を整備し、試験データを用いて検証すること、さらに、代表的な格納容器AM策に適用したその有効性が評価されている。この一環として下記の2点の検討結果が報告されている。</p> <p><b>【1. PANDA 試験の試験前解析】</b></p> <p>格納容器内熱流動研究に関する OECD 国際協力プロジェクト PANDA 試験のデータを用いて格納容器内熱流動解析手法を検証するとともに、PANDA 試験の格納容器自然対流冷却試験シリーズの試験前解析を実施しており、クーラ周辺の詳細流動等のクーラ特性に係る有用な知見を得ている。</p> <p><b>【2. 実炉解析】</b></p> <p>上記で検証した解析手法を PWR 実炉の格納容器体系に適用して、SA 時に格納容器自然対流冷却を実施した場合のクーラ除熱効果や格納容器内温度分布、混合ガスの濃度分布等を評価している。解析メッシュは上記より粗いものの、格納容器自然対流冷却 AM は格納容器内雰囲気を効果的に冷却させることを確認している。</p> <p>なお、これらの内容は以下の報告書に纏められている。</p> <p>①アクシデントマネジメント知識ベース整備に関する報告書（格納容器内多次元流動解析手法の検証と自然対流冷却 AM 策への適用）(H17～H19 年度)</p> <p>②アクシデントマネジメント時格納容器内多次元熱流動及び FP 挙動解析(H20～H21 年度)</p> <p>以下では、格納容器再循環ユニットによる自然対流冷却の自然対流冷却発生プロセスについて、上記報告書に纏められたこれらの2点の検討結果に基づき、以下に定量的考察を説明する。</p> <p>1. PANDA 試験の試験前解析</p> <p>PANDA 試験の試験前解析は H17～H21 年度まで毎年実施しているが、ダクト系を模擬した再循環クーラの解析については H20 年度と H21 年度にて実施している。ここでこのうち最新の H21 年度報告書をモデルとして説明する。</p> <p>(1)解析モデルと解析条件</p>	

赤字：設備、運用又は体制の相違（設計方針の相違）  
 青字：記載箇所又は記載内容の相違（記載方針の相違）  
 緑字：記載表現、設備名称の相違（実質的な相違なし）

第50条 原子炉格納容器の過圧破損を防止するための設備

大飯発電所3 / 4号炉	泊発電所3号炉	相違理由
<p>H21年度のPANDA試験のST4シリーズは自然対流冷却AM策を模擬した試験でクーラの配置、及びクーラ下部のダクト有無の影響について模擬格納容器内(DW)の流れに及ぼす影響を把握するものである。PANDA試験の解析モデルを図1に、解析条件を表1に示す。</p> <p>図1に示す通りで、クーラは伝熱管とケーシングで構成され、気体が入り出す一側面のみを開放する形状としている。伝熱管群は開放側面に面して奥行を持ち配置されている。クーラ下部へダクトを配置するケースでは、ケーシング奥側の伝熱管群が存在しない領域の中心にダクトを配置する形状としている。DW内のクーラの配置はDW内上段と中段に配置する2ケースを実施している。本説明では、ダクト有で、流入蒸気の成層化の影響を受け難いDW上段設置のケースST4-1をモデルケースとする。</p> <p>表1に示す通りで、DW内の初期圧力は1.3barで、SA時に想定される格納容器内への流入条件として前半1000秒(Phase1)は水蒸気のみが流入し、後半1000秒(Phase2)は水素ガスを模擬したヘリウムと水蒸気の混合ガスが流入する。本説明では、クーラ作動から自然対流の流れが形成され、除熱量が安定化するまでの過程を把握できるPhase1をモデルケースとする。</p>	<p>H21年度のPANDA試験のST4シリーズは自然対流冷却AM策を模擬した試験でクーラの配置、及びクーラ下部のダクト有無の影響について模擬格納容器内(DW)の流れに及ぼす影響を把握するものである。PANDA試験の解析モデルを図1に、解析条件を表1に示す。</p> <p>図1に示す通りで、クーラは伝熱管とケーシングで構成され、気体が入り出す一側面のみを開放する形状としている。伝熱管群は開放側面に面して奥行を持ち配置されている。クーラ下部へダクトを配置するケースでは、ケーシング奥側の伝熱管群が存在しない領域の中心にダクトを配置する形状としている。DW内のクーラの配置はDW内上段と中段に配置する2ケースを実施している。本説明では、ダクト有で、流入蒸気の成層化の影響を受け難いDW上段設置のケースST4-1をモデルケースとする。</p> <p>表1に示す通りで、DW内の初期圧力は1.3barで、SA時に想定される格納容器内への流入条件として前半1000秒(Phase1)は水蒸気のみが流入し、後半1000秒(Phase2)は水素ガスを模擬したヘリウムと水蒸気の混合ガスが流入する。本説明では、クーラ作動から自然対流の流れが形成され、除熱量が安定化するまでの過程を把握できるPhase1をモデルケースとする。</p>	

赤字：設備、運用又は体制の相違（設計方針の相違）  
 青字：記載箇所又は記載内容の相違（記載方針の相違）  
 緑字：記載表現、設備名称の相違（実質的な相違なし）

第50条 原子炉格納容器の過圧破損を防止するための設備

大飯発電所3/4号炉



図1 PANDA試験の試験前解析モデル図

表1 PANDA試験の試験前解析条件

ST4	DW内初期条件			ガス流入条件(インジェクション)		
	圧力	温度	気相組成	組成	流速	温度
Phase1	1.3bar	108℃	空気	水蒸気	40m/s	140℃
Phase2	Phase1 結果	Phase1 結果	Phase1 結果	水蒸気 ヘリウム	40m/s 25m/s	140℃

泊発電所3号炉

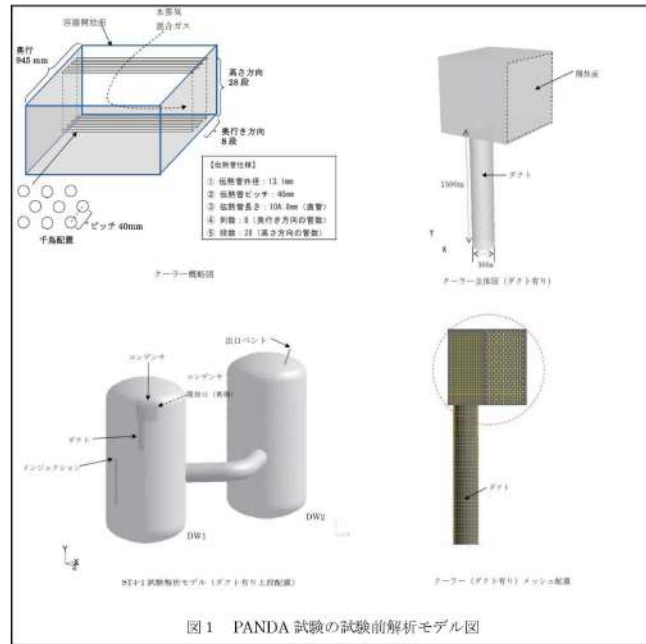

図1 PANDA試験の試験前解析モデル図

表1 PANDA試験の試験前解析条件

ST4	DW内初期条件			ガス流入条件(インジェクション)		
	圧力	温度	気相組成	組成	流速	温度
Phase1	1.3[bar]	108[℃]	空気	水蒸気	40[m/s]	140[℃]
Phase2	Phase1 結果	Phase1 結果	Phase1 結果	水蒸気 ヘリウム	40[m/s] 25[m/s]	140[℃]

相違理由

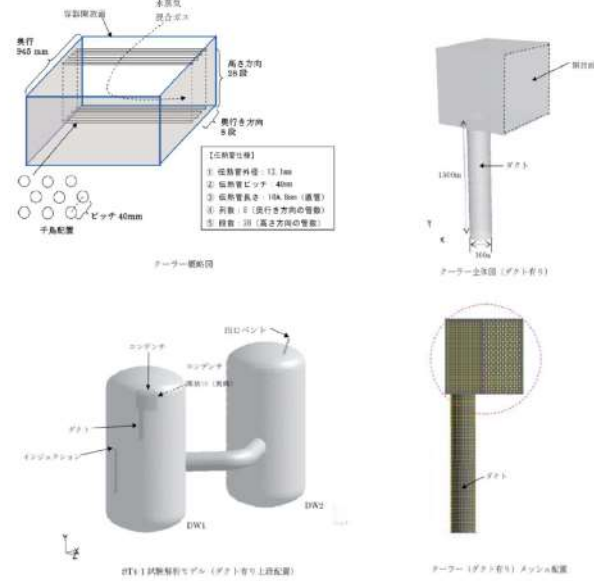
赤字：設備、運用又は体制の相違（設計方針の相違）  
 青字：記載箇所又は記載内容の相違（記載方針の相違）  
 緑字：記載表現、設備名称の相違（実質的な相違なし）

第50条 原子炉格納容器の過圧破損を防止するための設備

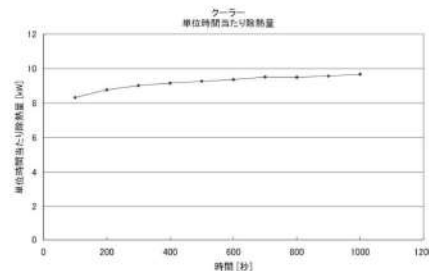
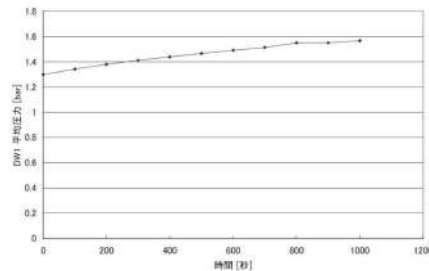
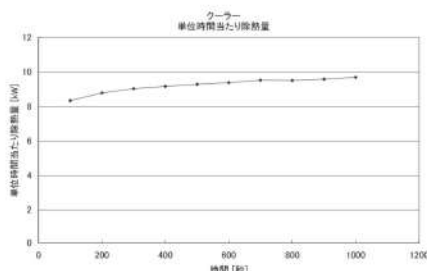
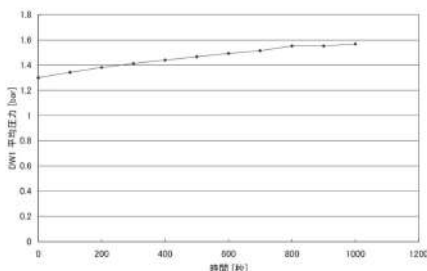
大飯発電所3/4号炉	泊発電所3号炉	相違理由
<p>(2)解析結果</p> <p>クーラ除熱量及びDW内圧力の時間変化を図2、及び図3に示す。また、クーラ除熱がほぼ安定化した時刻での流速分布、温度分布、水蒸気モル分布を図5～図7に示す。</p> <p>図2の除熱量の時間変化より、除熱量は200秒までにほぼ安定化した状態となっており、その後は図3に示すDW内での圧力の上昇に追従して、増加する変化を示している。</p> <p>図5に示す1000秒後のDW内の流速分布図では、流れはクーラ入口から水平に侵入し、クーラ内で下降流となって下部ダクトを降下してダクト下部からDWへ流出する流れが形成されている。また、クーラ入口の流速分布は入口上部ほど高速の流れを示しており、クーラ下部では流れの一部が正面からクーラ外側へ下降流となってDWへ流出している。</p> <p>図6、図7の温度分布、水蒸気モル分布図ではクーラ内部、ダクト内部がDW内と比較して冷却され、水蒸気の割合が低下していることが確認できる。クーラ下部については冷却空気が滞留し、滞留空気の一部がクーラ下部から直接DW内へ流出することが確認できる。</p>  <p>図2 除熱量時間変化(ST4-1 試験)</p>  <p>図3 試験容器内平均圧力時間変化(ST4-1 試験)</p>	<p>(2)解析結果</p> <p>クーラ除熱量及びDW内圧力の時間変化を図2、及び図3に示す。また、クーラ除熱がほぼ安定化した時刻での流速分布、温度分布、水蒸気モル分布を図5～図7に示す。</p> <p>図2の除熱量の時間変化より、除熱量は200秒までにほぼ安定化した状態となっており、その後は図3に示すDW内での圧力の上昇に追従して、増加する変化を示している。</p> <p>図5に示す1000秒後のDW内の流速分布図では、流れはクーラ入口から水平に侵入し、クーラ内で下降流となって下部ダクトを降下してダクト下部からDWへ流出する流れが形成されている。また、クーラ入口の流速分布は入口上部ほど高速の流れを示しており、クーラ下部では流れの一部が正面からクーラ外側へ下降流となってDWへ流出している。</p> <p>図6、図7の温度分布、水蒸気モル分布図ではクーラ内部、ダクト内部がDW内と比較して冷却され、水蒸気の割合が低下していることが確認できる。クーラ下部については冷却空気が滞留し、滞留空気の一部がクーラ下部から直接DW内へ流出することが確認できる。</p>  <p>図2 除熱量時間変化(ST4-1 試験)</p>  <p>図3 試験容器内平均圧力時間変化(ST4-1 試験)</p>	

赤字：設備、運用又は体制の相違（設計方針の相違）  
 青字：記載箇所又は記載内容の相違（記載方針の相違）  
 緑字：記載表現、設備名称の相違（実質的な相違なし）

第50条 原子炉格納容器の過圧破損を防止するための設備

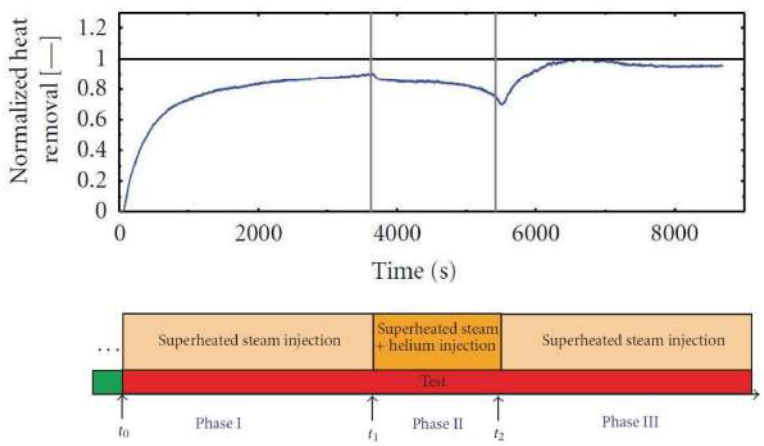
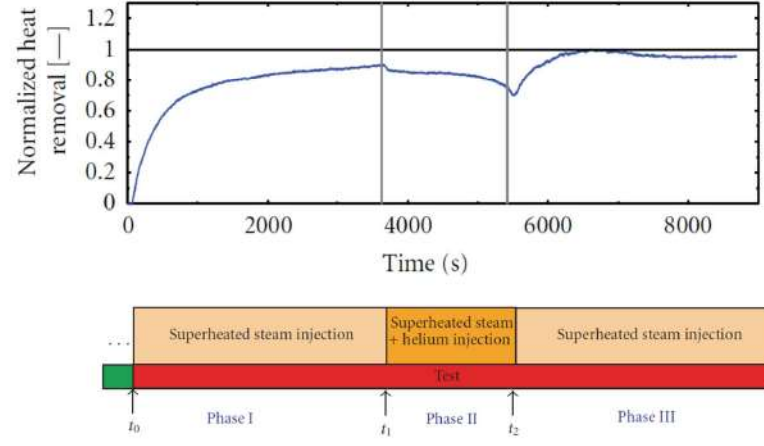
大飯発電所3/4号炉	泊発電所3号炉	相違理由
<p>本試験前解析に対応するPANDA試験結果のクーラ除熱量の時間変化を図4に示す。</p> <p>図4に示す通りで、除熱量は約1000秒でほぼ安定化する結果となっており、図2に示す試験前解析の結果より若干安定化までの時間は要しているものの、ほぼ同様の傾向を示す結果となった。</p>  <p>図4 PANDA試験結果での除熱量時間変化(ST4試験)</p> <p>出典：Ralf Kapulla, Guillaume Mignot, and Domenico Paladino, Laboratory for Thermalhydraulics (LTH), Paul Scherrer Institut, 5232 Villigen, Switzerland, "Large-Scale Containment Cooler Performance Experiments under Accident Conditions", in Science and Technology of Nuclear Installations, "Severe Accident Analysis in Nuclear Power Plants"</p>	<p>本試験前解析に対応するPANDA試験結果のクーラ除熱量の時間変化を図4に示す。</p> <p>図4に示す通りで、除熱量は約1000秒でほぼ安定化する結果となっており、図2に示す試験前解析の結果より若干安定化までの時間は要しているものの、ほぼ同様の傾向を示す結果となった。</p>  <p>図4 PANDA試験結果での除熱量時間変化(ST4試験)</p> <p>出典：Ralf Kapulla, Guillaume Mignot, and Domenico Paladino, Laboratory for Thermalhydraulics (LTH), Paul Scherrer Institut, 5232 Villigen, Switzerland, "Large-Scale Containment Cooler Performance Experiments under Accident Conditions", in Science and Technology of Nuclear Installations, "Severe Accident Analysis in Nuclear Power Plants"</p>	

赤字：設備、運用又は体制の相違（設計方針の相違）  
 青字：記載箇所又は記載内容の相違（記載方針の相違）  
 緑字：記載表現、設備名称の相違（実質的な相違なし）

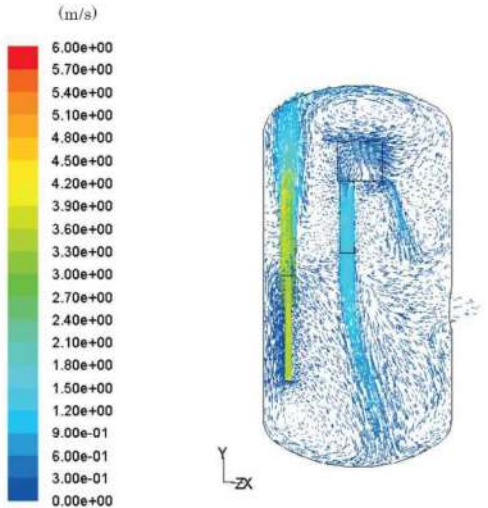
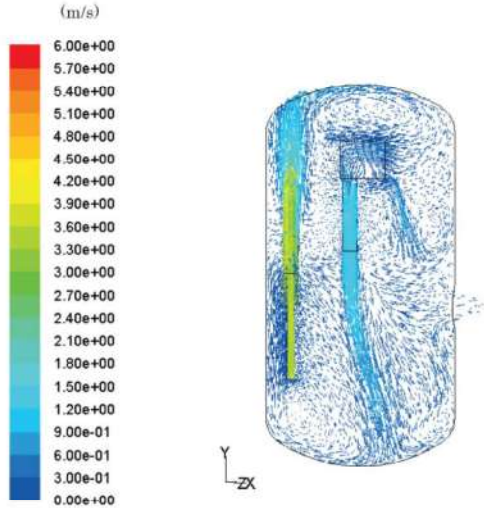
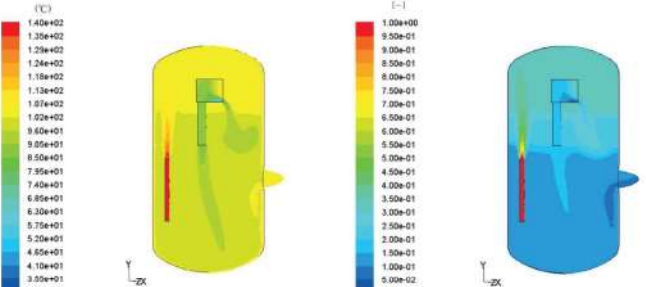
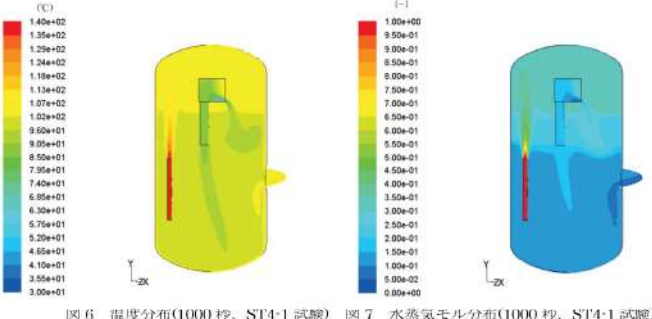
大飯発電所3 / 4号炉	泊発電所3号炉	相違理由
 <p>(m/s)</p> <p>6.00e+00 5.70e+00 5.40e+00 5.10e+00 4.80e+00 4.50e+00 4.20e+00 3.90e+00 3.60e+00 3.30e+00 3.00e+00 2.70e+00 2.40e+00 2.10e+00 1.80e+00 1.50e+00 1.20e+00 9.00e-01 6.00e-01 3.00e-01 0.00e+00</p>	 <p>(m/s)</p> <p>6.00e+00 5.70e+00 5.40e+00 5.10e+00 4.80e+00 4.50e+00 4.20e+00 3.90e+00 3.60e+00 3.30e+00 3.00e+00 2.70e+00 2.40e+00 2.10e+00 1.80e+00 1.50e+00 1.20e+00 9.00e-01 6.00e-01 3.00e-01 0.00e+00</p>	
<p>図5 流速分布(1000秒、ST4-1試験)</p>	<p>図5 流速分布(1000秒、ST4-1試験)</p>	
 <p>(°C)</p> <p>1.40e+02 1.35e+02 1.29e+02 1.24e+02 1.18e+02 1.13e+02 1.07e+02 1.02e+02 9.60e+01 9.00e+01 8.50e+01 7.95e+01 7.40e+01 6.85e+01 6.30e+01 5.75e+01 5.20e+01 4.65e+01 4.10e+01 3.55e+01 3.00e+01</p> <p>(°C)</p> <p>1.00e+00 9.50e-01 9.00e-01 8.50e-01 8.00e-01 7.50e-01 7.00e-01 6.50e-01 6.00e-01 5.50e-01 5.00e-01 4.50e-01 4.00e-01 3.50e-01 3.00e-01 2.50e-01 2.00e-01 1.50e-01 1.00e-01 5.00e-02 0.00e+00</p>	 <p>(°C)</p> <p>1.40e+02 1.35e+02 1.29e+02 1.24e+02 1.18e+02 1.13e+02 1.07e+02 1.02e+02 9.60e+01 9.00e+01 8.50e+01 7.95e+01 7.40e+01 6.85e+01 6.30e+01 5.75e+01 5.20e+01 4.65e+01 4.10e+01 3.55e+01 3.00e+01</p> <p>(-)</p> <p>1.00e+00 9.50e-01 9.00e-01 8.50e-01 8.00e-01 7.50e-01 7.00e-01 6.50e-01 6.00e-01 5.50e-01 5.00e-01 4.50e-01 4.00e-01 3.50e-01 3.00e-01 2.50e-01 2.00e-01 1.50e-01 1.00e-01 5.00e-02 0.00e+00</p>	
<p>図6 温度分布(1000秒、ST4-1試験) 図7 水蒸気モル分布(1000秒、ST4-1試験)</p>	<p>図6 温度分布(1000秒、ST4-1試験) 図7 水蒸気モル分布(1000秒、ST4-1試験)</p>	



赤字：設備、運用又は体制の相違（設計方針の相違）  
 青字：記載箇所又は記載内容の相違（記載方針の相違）  
 緑字：記載表現、設備名称の相違（実質的な相違なし）

第50条 原子炉格納容器の過圧破損を防止するための設備

大飯発電所3/4号炉	泊発電所3号炉	相違理由
<p>2. 実炉解析</p> <p>実炉解析はH17～H21年度まで毎年実施しているが、再循環クーラの除熱量の時間変化が掲載されている報告書はH17～H19年度までである。ここでは1項、PANDA試験解析に基づく実炉解析と、除熱量の時間変化が掲載される最新のH19年度報告書をモデルとして説明する。</p> <p>2. 1 H21年度の実炉解析</p> <p>(1)解析モデルと解析条件</p> <p>H21年度の実炉解析は、ST4試験のPANDA試験解析で得た解析手法及び知見をドライ型PWR4ループプラントの実炉スケールの格納容器へ適用して重大事故時の条件下の実炉格納容器内の解析を実施している。</p> <p>実炉解析での解析モデルを図8に、解析条件を表2に示す。</p> <p>図8に示す通りで、格納容器モデルは上部コンパートメントの自由空間だけでなく、互いに階段やグレーチング等の開口で連通する下部コンパートメントを含む、全体系を対象としており、オペレーティングフロアにはダクト付きの再循環クーラを模擬している。</p> <p>再循環クーラの冷却モデルは、クーラ単体の除熱性能を基に、クーラ内各セルあたりの除熱量を時々刻々計算して、格納容器体系の除熱量を計算するもので、局所的な流動や雰囲気温度の影響及びダクト等の周辺形状の効果を解析できるモデルとなっている。</p> <p>SA後の事象進展が準静的に至った状態を想定して流動解析を実施している。破断箇所はループ室内、加圧器室の配管破断と原子炉下部ヘッ드의破損を想定しているが本説明では代表的なケースとしてループ室破断をモデルケースとする。表2に示す通りで、初期条件はクーラが作動する条件で、かつ、格納容器内流れ場が安定している状態における温度、圧力及び気相組成を初期条件としている。流入条件は原子炉キャビティ室床面からガスを流入させている。</p>	<p>2. 実炉解析</p> <p>実炉解析はH17～H21年度まで毎年実施しているが、再循環クーラの除熱量の時間変化が掲載されている報告書はH17～H19年度までである。ここでは1項、PANDA試験解析に基づく実炉解析と、除熱量の時間変化が掲載される最新のH19年度報告書をモデルとして説明する。</p> <p>2. 1 H21年度の実炉解析</p> <p>(1)解析モデルと解析条件</p> <p>H21年度の実炉解析は、ST4試験のPANDA試験解析で得た解析手法及び知見をドライ型PWR4ループプラントの実炉スケールの格納容器へ適用して重大事故時の条件下の実炉格納容器内の解析を実施している。</p> <p>実炉解析での解析モデルを図8に、解析条件を表2に示す。</p> <p>図8に示す通りで、格納容器モデルは上部コンパートメントの自由空間だけでなく、互いに階段やグレーチング等の開口で連通する下部コンパートメントを含む、全体系を対象としており、オペレーティングフロアにはダクト付きの再循環クーラを模擬している。</p> <p>再循環クーラの冷却モデルは、クーラ単体の除熱性能を基に、クーラ内各セルあたりの除熱量を時々刻々計算して、格納容器体系の除熱量を計算するもので、局所的な流動や雰囲気温度の影響及びダクト等の周辺形状の効果を解析できるモデルとなっている。</p> <p>SA後の事象進展が準静的に至った状態を想定して流動解析を実施している。破断箇所はループ室内、加圧器室の配管破断と原子炉下部ヘッ드의破損を想定しているが本説明では代表的なケースとしてループ室破断をモデルケースとする。表2に示す通りで、初期条件はクーラが作動する条件で、かつ、格納容器内流れ場が安定している状態における温度、圧力及び気相組成を初期条件としている。流入条件は原子炉キャビティ室床面からガスを流入させている。</p>	

赤字：設備、運用又は体制の相違（設計方針の相違）  
 青字：記載箇所又は記載内容の相違（記載方針の相違）  
 緑字：記載表現、設備名称の相違（実質的な相違なし）

第50条 原子炉格納容器の過圧破損を防止するための設備

大飯発電所3/4号炉

泊発電所3号炉

相違理由



表2 実炉解析条件

破断位置	格納容器内初期条件		ガス流入条件（原子炉キャビディ）	
	圧力/温度	気相質量分率 空気/蒸気/水素	流入流量	質量分率 空気/蒸気/水素
ループ室	0.164MPa/127℃	0.54/0.43/0.03	$7.969 \times 10^{-2} \text{kg/s}$	0.44/0.30/0.26

表2 実炉解析条件

破断位置	格納容器内初期条件		ガス流入条件（原子炉キャビディ）	
	圧力/温度	気相質量分率 空気/蒸気/水素	流入流量	質量分率 空気/蒸気/水素
ループ室	0.164 [MPa] /127 [°C]	0.54/0.43/0.03	$7.969 \times 10^{-2}$ [kg/s]	0.44/0.30/0.26

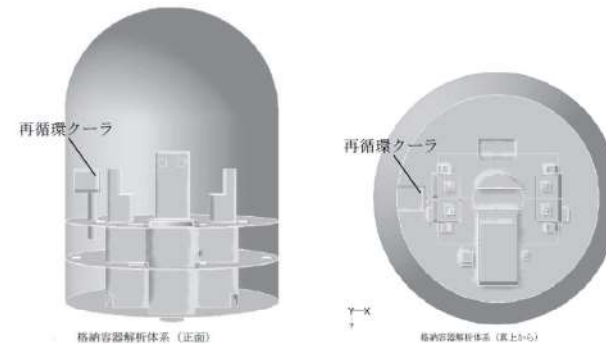
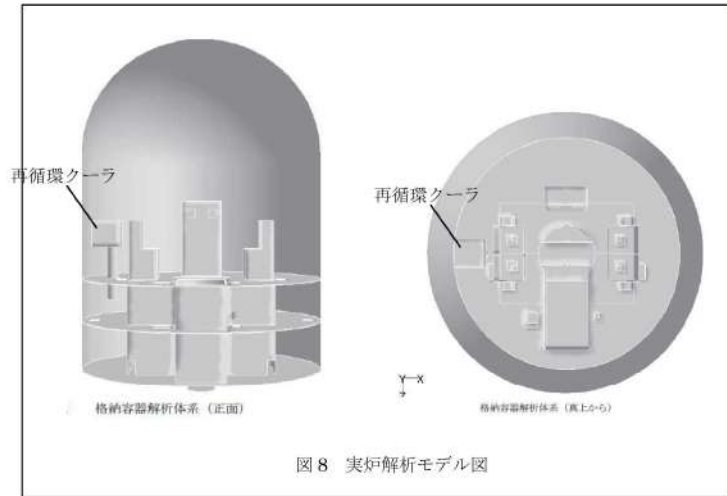
赤字：設備、運用又は体制の相違（設計方針の相違）  
 青字：記載箇所又は記載内容の相違（記載方針の相違）  
 緑字：記載表現、設備名称の相違（実質的な相違なし）

第50条 原子炉格納容器の過圧破損を防止するための設備

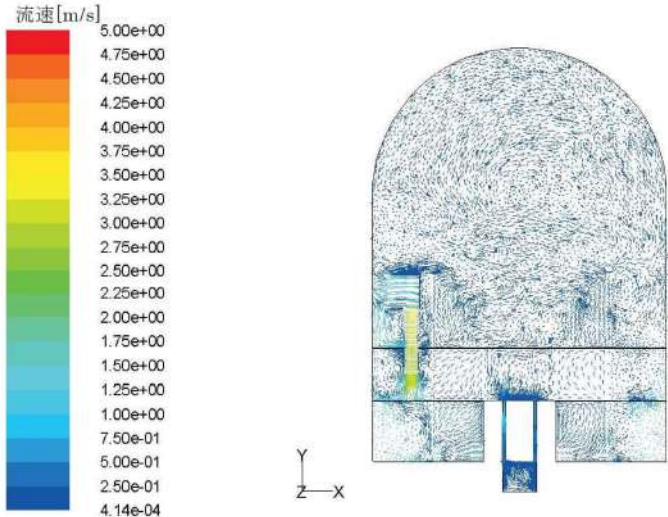
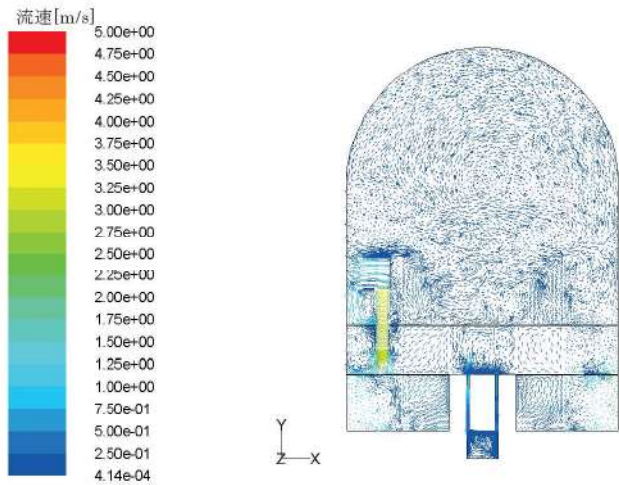
大飯発電所3 / 4号炉	泊発電所3号炉	相違理由
<p>(2)解析結果</p> <p>格納容器内の流速分布、温度分布、水蒸気モル分布を図9～図11に示す。図9に示す3600秒後の流速分布図では、流れはクーラ入口から水平に侵入し、クーラ内で下降流となって下部ダクトを降下してダクト下部から格納容器へ流出する流れが形成されている。また、クーラ入口の流速分布は入口下部で低速の流線を示しており、クーラ下部では流れの一部が正面からクーラ外側へ下降流となって格納容器内へ流出している。図10、図11の温度分布、水蒸気モル分布図ではクーラ内部、ダクト内部が格納容器内と比較して冷却され、水蒸気の割合が低下していることが確認できる。クーラ下部については冷却空気が滞留し、滞留空気の一部がクーラ下部から直接格納容器内へ流出することが確認できる。</p>  <p>図9 流速分布(3600秒、ループ室破断)</p>	<p>(2)解析結果</p> <p>格納容器内の流速分布、温度分布、水蒸気モル分布を図9～図11に示す。図9に示す3600秒後の流速分布図では、流れはクーラ入口から水平に侵入し、クーラ内で下降流となって下部ダクトを降下してダクト下部から格納容器へ流出する流れが形成されている。また、クーラ入口の流速分布は入口下部で低速の流線を示しており、クーラ下部では流れの一部が正面からクーラ外側へ下降流となって格納容器内へ流出している。図10、図11の温度分布、水蒸気モル分布図ではクーラ内部、ダクト内部が格納容器内と比較して冷却され、水蒸気の割合が低下していることが確認できる。クーラ下部については冷却空気が滞留し、滞留空気の一部がクーラ下部から直接格納容器内へ流出することが確認できる。</p>  <p>図3.12 流速分布（ケース1：3600秒、z=0m）</p>	

赤字：設備、運用又は体制の相違（設計方針の相違）  
 青字：記載箇所又は記載内容の相違（記載方針の相違）  
 緑字：記載表現、設備名称の相違（実質的な相違なし）

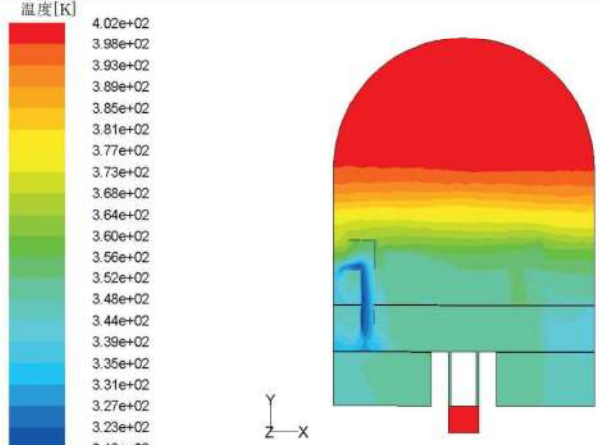
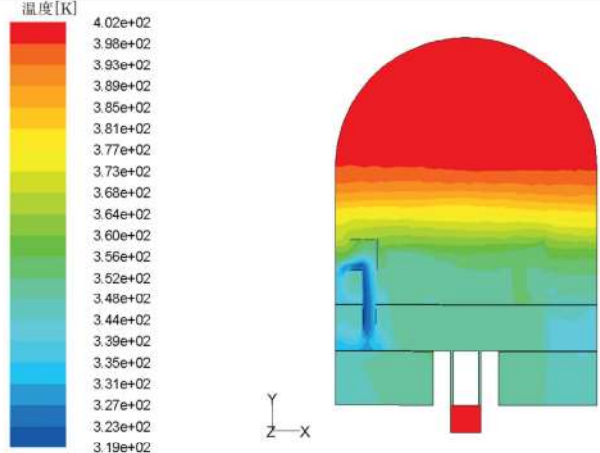
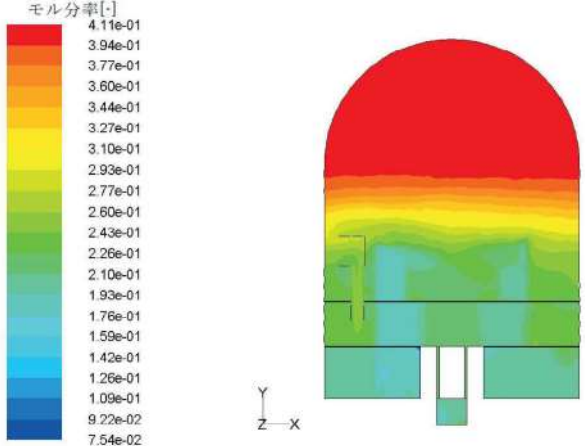
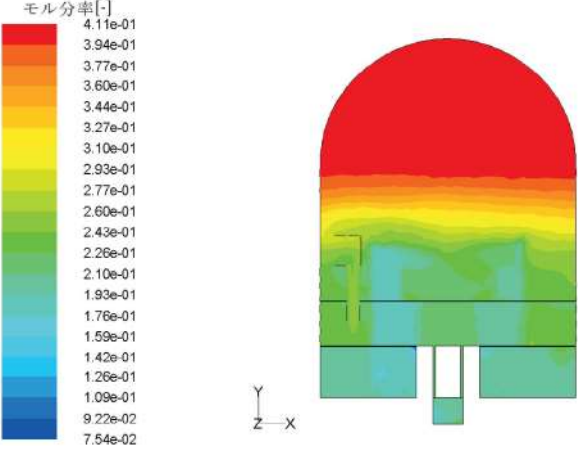
大飯発電所 3 / 4 号炉	泊発電所 3 号炉	相違理由
 <p>温度 [K]</p> <p>4.02e+02 3.98e+02 3.93e+02 3.89e+02 3.85e+02 3.81e+02 3.77e+02 3.73e+02 3.68e+02 3.64e+02 3.60e+02 3.56e+02 3.52e+02 3.48e+02 3.44e+02 3.39e+02 3.35e+02 3.31e+02 3.27e+02 3.23e+02 3.19e+02</p> <p>Y Z—X</p>	 <p>温度 [K]</p> <p>4.02e+02 3.98e+02 3.93e+02 3.89e+02 3.85e+02 3.81e+02 3.77e+02 3.73e+02 3.68e+02 3.64e+02 3.60e+02 3.56e+02 3.52e+02 3.48e+02 3.44e+02 3.39e+02 3.35e+02 3.31e+02 3.27e+02 3.23e+02 3.19e+02</p> <p>Y Z—X</p>	
<p>図 10 温度分布(3600 秒、ループ室破断)</p>	<p>図 10 温度分布(3600 秒、ループ室破断)</p>	
 <p>モル分率 [-]</p> <p>4.11e-01 3.94e-01 3.77e-01 3.60e-01 3.44e-01 3.27e-01 3.10e-01 2.93e-01 2.77e-01 2.60e-01 2.43e-01 2.26e-01 2.10e-01 1.93e-01 1.76e-01 1.59e-01 1.42e-01 1.26e-01 1.09e-01 9.22e-02 7.54e-02</p> <p>Y Z—X</p>	 <p>モル分率 [-]</p> <p>4.11e-01 3.94e-01 3.77e-01 3.60e-01 3.44e-01 3.27e-01 3.10e-01 2.93e-01 2.77e-01 2.60e-01 2.43e-01 2.26e-01 2.10e-01 1.93e-01 1.76e-01 1.59e-01 1.42e-01 1.26e-01 1.09e-01 9.22e-02 7.54e-02</p> <p>Y Z—X</p>	
<p>図 11 水蒸気モル分布(3600 秒、ループ室破断)</p>	<p>図 11 水蒸気モル分布(3600 秒、ループ室破断)</p>	

赤字：設備、運用又は体制の相違（設計方針の相違）  
 青字：記載箇所又は記載内容の相違（記載方針の相違）  
 緑字：記載表現、設備名称の相違（実質的な相違なし）

第50条 原子炉格納容器の過圧破損を防止するための設備

大飯発電所3/4号炉	泊発電所3号炉	相違理由																												
<p>2. 2 H19年度の実炉解析</p> <p>(1)解析モデルと解析条件</p> <p>H19年度の実炉解析は、ダクト無クーラを用いたTest25のPANDA試験解析で得た解析手法及び知見をドライ型PWR4ループプラントの実炉スケールの格納容器へ適用して重大事故時の条件下の実炉格納容器内の解析を実施している。</p> <p>実炉解析の解析モデルはH21年度と同様であり図8に示す。</p> <p>解析は定常計算にて格納容器内流動を確立させた後に、クーラを作動させて非定常計算を実施しており、破断箇所はループ室内、加圧器室の配管破断を想定しているが本説明では代表的なケースとしてループ室破断をモデルケースとする。解析条件は表3に示す。</p> <p style="text-align: center;">表3 実炉解析条件</p> <table border="1" data-bbox="183 539 952 692"> <thead> <tr> <th rowspan="2">破断位置</th> <th colspan="2">格納容器内初期条件</th> <th colspan="2">ガス流入条件（蒸気発生器基礎部部）</th> </tr> <tr> <th>圧力/温度</th> <th>気相質量分率 空気/蒸気/水素</th> <th>流入流量</th> <th>流入温度</th> </tr> </thead> <tbody> <tr> <td>ループ室</td> <td>0.49MPa/140℃</td> <td>0.26/0.74/0.0</td> <td>10 kg/s /1.0kg/s</td> <td>152℃</td> </tr> </tbody> </table> <p>(2)解析結果</p> <p>クーラ除熱量の時間変化を図12に示す。また、解析開始から100秒、400秒、1000秒後の流速分布、温度分布、水蒸気質量分率分布を図13～図15に示す。</p> <p>図12の除熱量の時間変化より、クーラ作動開始後約15秒の間にクーラ除熱量が一時的に減少する期間があるが、これはクーラを通過する流れが確立するまでの期間に相当する。クーラを通過する流れがほぼ確立した15秒以降では小さな変動が時々見られる程度であり、300秒以降は除熱量がゆるやかに減少傾向となっているが、これは格納容器内雰囲気温度が全体的に低下しているためであり、クーラの冷却効果が非常に大きいものであることを示している。</p> <p>図13に示す流速分布図では、100秒後では既に安定した自然対流を形成しており、400秒後、1000秒後でもこの傾向に大きな変化はない。流れはクーラ入口から水平に侵入し、クーラ内で下降流となって下部ダクトを降下してダクト下部から格納容器へ流出する流れが形成されている。また、クーラ入口の流速分布は入口下部で低速の流線を示しており、クーラ下部では流れの一部が正面からクーラ外側へ下降流となって格納容器内へ流出している。また、図14、図15の温度分布、水蒸気質量分率分布図ではクーラ内部、ダクト内部が格納容器内と比較して冷却され、水蒸気の割合が低下していることが確認できる。クーラ下部については冷却空気が滞留し、滞留空気の一部がクーラ下部から直接格納容器内へ流出することが確認でき、これはH21年度の結果と同様である。</p>	破断位置	格納容器内初期条件		ガス流入条件（蒸気発生器基礎部部）		圧力/温度	気相質量分率 空気/蒸気/水素	流入流量	流入温度	ループ室	0.49MPa/140℃	0.26/0.74/0.0	10 kg/s /1.0kg/s	152℃	<p>2. 2 H19年度の実炉解析</p> <p>(1)解析モデルと解析条件</p> <p>H19年度の実炉解析は、ダクト無クーラを用いたTest25のPANDA試験解析で得た解析手法及び知見をドライ型PWR4ループプラントの実炉スケールの格納容器へ適用して重大事故時の条件下の実炉格納容器内の解析を実施している。</p> <p>実炉解析の解析モデルはH21年度と同様であり図8に示す。</p> <p>解析は定常計算にて格納容器内流動を確立させた後に、クーラを作動させて非定常計算を実施しており、破断箇所はループ室内、加圧器室の配管破断を想定しているが本説明では代表的なケースとしてループ室破断をモデルケースとする。解析条件は表3に示す。</p> <p style="text-align: center;">表3 実炉解析条件</p> <table border="1" data-bbox="1093 539 1928 724"> <thead> <tr> <th rowspan="2">破断位置</th> <th colspan="2">格納容器内初期条件</th> <th colspan="2">ガス流入条件（蒸気発生器基礎部部）</th> </tr> <tr> <th>圧力/温度</th> <th>気相質量分率 空気/蒸気/水素</th> <th>流入流量 蒸気/水素</th> <th>流入温度</th> </tr> </thead> <tbody> <tr> <td>ループ室</td> <td>0.49[MPa]/140[℃]</td> <td>0.26/0.74/0.0</td> <td>10[kg/s]/1.0[kg/s]</td> <td>152[℃]</td> </tr> </tbody> </table> <p>(2)解析結果</p> <p>クーラ除熱量の時間変化を図12に示す。また、解析開始から100秒、400秒、1000秒後の流速分布、温度分布、水蒸気質量分率分布を図13～図15に示す。</p> <p>図12の除熱量の時間変化より、クーラ作動開始後約15秒の間にクーラ除熱量が一時的に減少する期間があるが、これはクーラを通過する流れが確立するまでの期間に相当する。クーラを通過する流れがほぼ確立した15秒以降では小さな変動が時々見られる程度であり、300秒以降は除熱量がゆるやかに減少傾向となっているが、これは格納容器内雰囲気温度が全体的に低下しているためであり、クーラの冷却効果が非常に大きいものであることを示している。</p> <p>図13に示す流速分布図では、100秒後では既に安定した自然対流を形成しており、400秒後、1000秒後でもこの傾向に大きな変化はない。流れはクーラ入口から水平に侵入し、クーラ内で下降流となって下部ダクトを降下してダクト下部から格納容器へ流出する流れが形成されている。また、クーラ入口の流速分布は入口下部で低速の流線を示しており、クーラ下部では流れの一部が正面からクーラ外側へ下降流となって格納容器内へ流出している。また、図14、図15の温度分布、水蒸気質量分率分布図ではクーラ内部、ダクト内部が格納容器内と比較して冷却され、水蒸気の割合が低下していることが確認できる。クーラ下部については冷却空気が滞留し、滞留空気の一部がクーラ下部から直接格納容器内へ流出することが確認でき、これはH21年度の結果と同様である。</p>	破断位置	格納容器内初期条件		ガス流入条件（蒸気発生器基礎部部）		圧力/温度	気相質量分率 空気/蒸気/水素	流入流量 蒸気/水素	流入温度	ループ室	0.49[MPa]/140[℃]	0.26/0.74/0.0	10[kg/s]/1.0[kg/s]	152[℃]	
破断位置		格納容器内初期条件		ガス流入条件（蒸気発生器基礎部部）																										
	圧力/温度	気相質量分率 空気/蒸気/水素	流入流量	流入温度																										
ループ室	0.49MPa/140℃	0.26/0.74/0.0	10 kg/s /1.0kg/s	152℃																										
破断位置	格納容器内初期条件		ガス流入条件（蒸気発生器基礎部部）																											
	圧力/温度	気相質量分率 空気/蒸気/水素	流入流量 蒸気/水素	流入温度																										
ループ室	0.49[MPa]/140[℃]	0.26/0.74/0.0	10[kg/s]/1.0[kg/s]	152[℃]																										

赤字：設備、運用又は体制の相違（設計方針の相違）  
 青字：記載箇所又は記載内容の相違（記載方針の相違）  
 緑字：記載表現、設備名称の相違（実質的な相違なし）

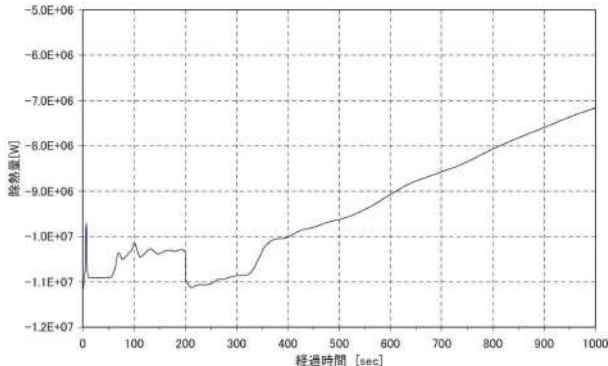
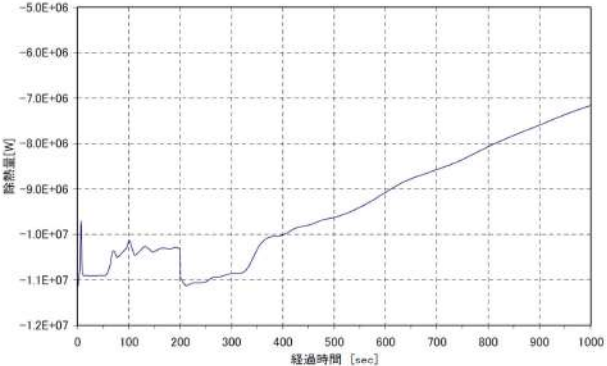
大飯発電所 3 / 4 号炉	泊発電所 3 号炉	相違理由
 <p data-bbox="510 794 741 815">図 12 除熱量時間変化(ケース 1)</p>	 <p data-bbox="1429 783 1659 804">図 12 除熱量時間変化(ケース 1)</p>	

赤字：設備、運用又は体制の相違（設計方針の相違）  
 青字：記載箇所又は記載内容の相違（記載方針の相違）  
 緑字：記載表現、設備名称の相違（実質的な相違なし）

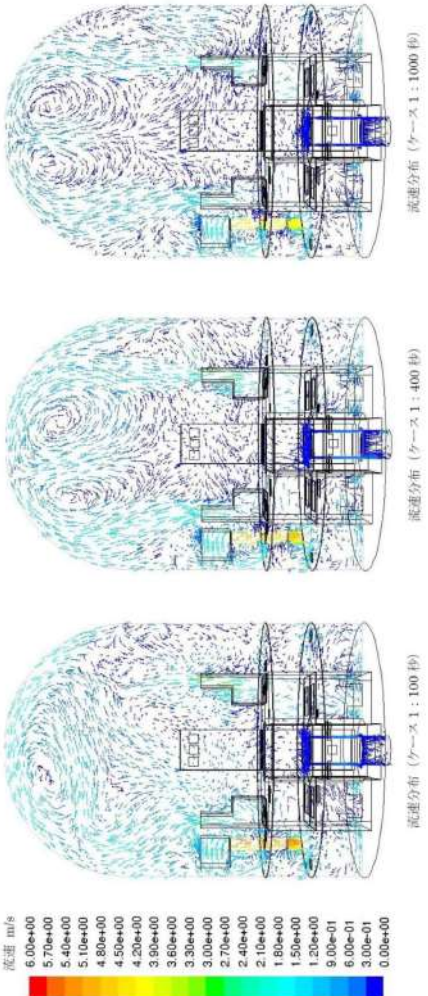
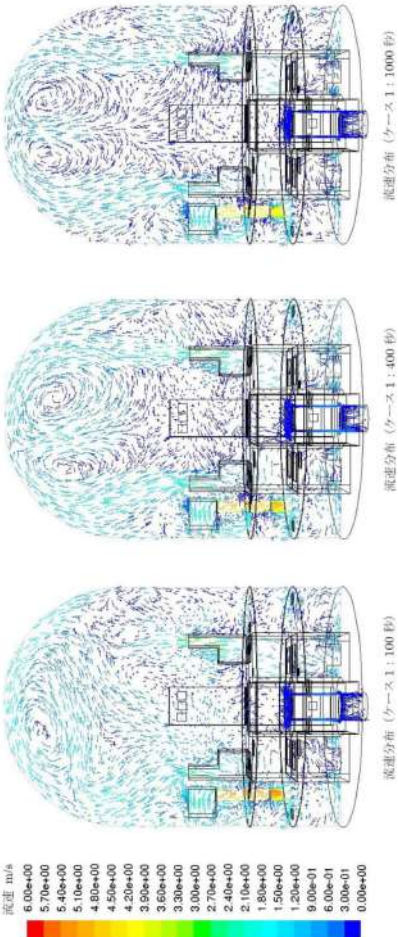
大飯発電所3 / 4号炉	泊発電所3号炉	相違理由
 <p>流速 m/s</p> <p>6.00e+00 5.70e+00 5.40e+00 5.10e+00 4.80e+00 4.50e+00 4.20e+00 3.90e+00 3.60e+00 3.30e+00 3.00e+00 2.70e+00 2.40e+00 2.10e+00 1.80e+00 1.50e+00 1.20e+00 9.00e-01 6.00e-01 3.00e-01 0.00e+00</p> <p>流速分布 (ケース1:100秒)</p> <p>流速分布 (ケース1:400秒)</p> <p>流速分布 (ケース1:1000秒)</p>	 <p>流速 m/s</p> <p>6.00e+00 5.70e+00 5.40e+00 5.10e+00 4.80e+00 4.50e+00 4.20e+00 3.90e+00 3.60e+00 3.30e+00 3.00e+00 2.70e+00 2.40e+00 2.10e+00 1.80e+00 1.50e+00 1.20e+00 9.00e-01 6.00e-01 3.00e-01 0.00e+00</p> <p>流速分布 (ケース1:100秒)</p> <p>流速分布 (ケース1:400秒)</p> <p>流速分布 (ケース1:1000秒)</p>	<p>図13 流速分布図(ケース1)</p> <p>図13 流速分布図(ケース1)</p>

赤字：設備、運用又は体制の相違（設計方針の相違）  
 青字：記載箇所又は記載内容の相違（記載方針の相違）  
 緑字：記載表現、設備名称の相違（実質的な相違なし）

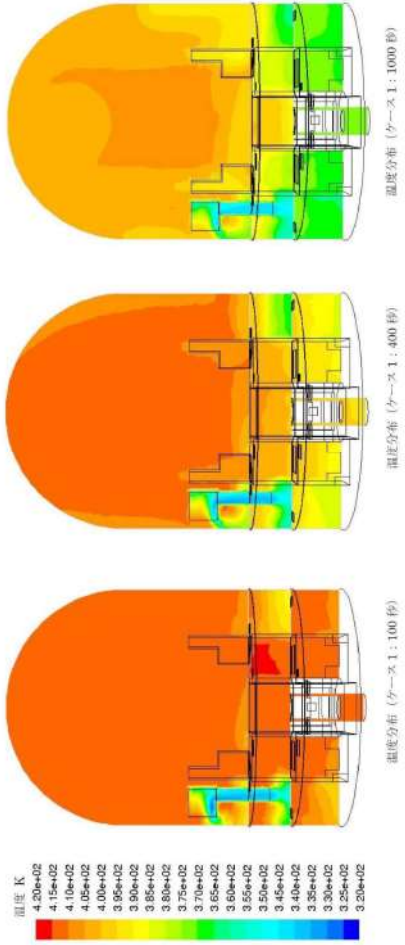
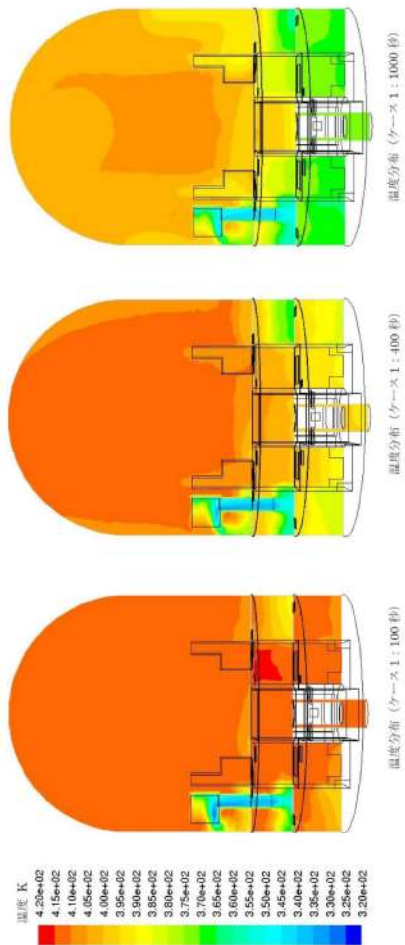
大飯発電所 3 / 4 号炉	泊発電所 3 号炉	相違理由
 <p>温度分布 (ケース 1: 100 秒)</p> <p>温度分布 (ケース 1: 400 秒)</p> <p>温度分布 (ケース 1: 1000 秒)</p> <p>温度 K</p> <p>4.20e+02 4.15e+02 4.10e+02 4.05e+02 4.00e+02 3.95e+02 3.90e+02 3.85e+02 3.80e+02 3.75e+02 3.70e+02 3.65e+02 3.60e+02 3.55e+02 3.50e+02 3.45e+02 3.40e+02 3.35e+02 3.30e+02 3.25e+02 3.20e+02</p>	 <p>温度分布 (ケース 1: 100 秒)</p> <p>温度分布 (ケース 1: 400 秒)</p> <p>温度分布 (ケース 1: 1000 秒)</p> <p>温度 K</p> <p>4.20e+02 4.15e+02 4.10e+02 4.05e+02 4.00e+02 3.95e+02 3.90e+02 3.85e+02 3.80e+02 3.75e+02 3.70e+02 3.65e+02 3.60e+02 3.55e+02 3.50e+02 3.45e+02 3.40e+02 3.35e+02 3.30e+02 3.25e+02 3.20e+02</p>	<p>相違理由</p>
<p>図 14 温度分布図(ケース 1)</p>		<p>図 14 温度分布図(ケース 1)</p>

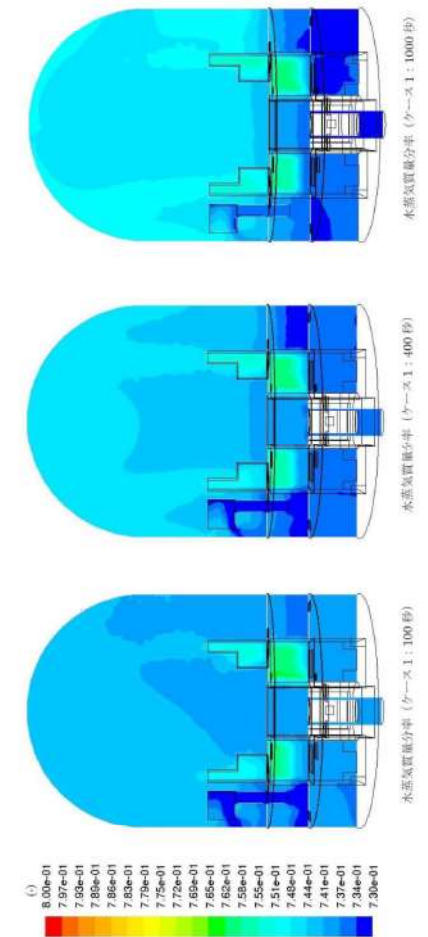
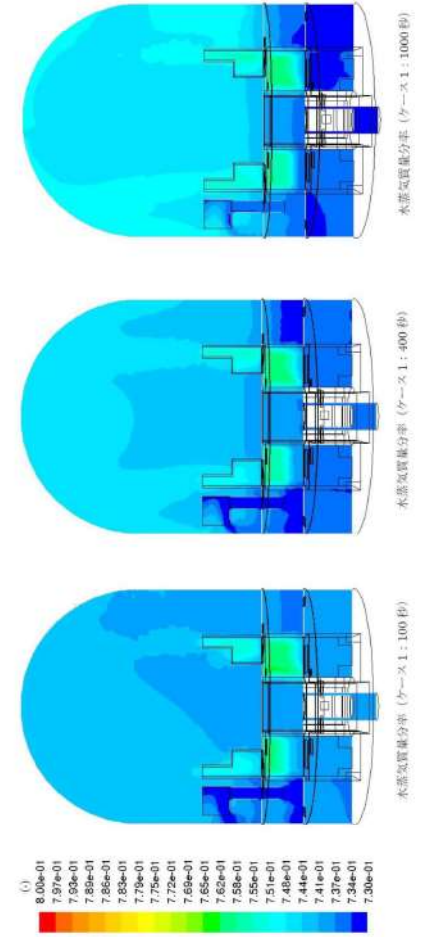

赤字：設備、運用又は体制の相違（設計方針の相違）  
 青字：記載箇所又は記載内容の相違（記載方針の相違）  
 緑字：記載表現、設備名称の相違（実質的な相違なし）

大飯発電所 3 / 4 号炉	泊発電所 3 号炉	相違理由
 <p>水蒸気質量分率 (ケース 1: 100 秒)</p> <p>水蒸気質量分率 (ケース 1: 400 秒)</p> <p>水蒸気質量分率 (ケース 1: 1000 秒)</p> <p>8.00e-01 7.97e-01 7.99e-01 7.89e-01 7.86e-01 7.83e-01 7.79e-01 7.75e-01 7.72e-01 7.69e-01 7.65e-01 7.62e-01 7.58e-01 7.55e-01 7.51e-01 7.48e-01 7.44e-01 7.41e-01 7.37e-01 7.34e-01 7.30e-01</p>	 <p>水蒸気質量分率 (ケース 1: 100 秒)</p> <p>水蒸気質量分率 (ケース 1: 400 秒)</p> <p>水蒸気質量分率 (ケース 1: 1000 秒)</p> <p>8.00e-01 7.97e-01 7.93e-01 7.89e-01 7.86e-01 7.83e-01 7.79e-01 7.75e-01 7.72e-01 7.69e-01 7.65e-01 7.62e-01 7.58e-01 7.55e-01 7.51e-01 7.48e-01 7.44e-01 7.41e-01 7.37e-01 7.34e-01 7.30e-01</p>	<p>相違理由</p>
<p>図 15 水蒸気質量分率分布図(ケース 1)</p>	<p>図 15 水蒸気質量分率分布図(ケース 1)</p>	

赤字：設備、運用又は体制の相違（設計方針の相違）  
 青字：記載箇所又は記載内容の相違（記載方針の相違）  
 緑字：記載表現、設備名称の相違（実質的な相違なし）

第50条 原子炉格納容器の過圧破損を防止するための設備

大飯発電所3/4号炉	泊発電所3号炉	相違理由
<p>3. PANDA 試験と実機条件との比較</p> <p>PANDA 試験のクーラモデルと実機再循環ユニットのダクト系を含めた形状は、それぞれ図1及び参考資料0の図1-2に示すようにほぼ同様（相似）な形状をしており、実機の方が大型である。</p> <p>一方、自然対流の流れの安定化には、主としてドラフト力と圧力損失、ユニット外からユニット内への初期流れの形成が影響するものと考えられる。ここで、ユニットの単位除熱能力（単位通過面積当たりの除熱量、及び単位流速を流した場合のコイル前後の温度（密度）変化量）が同様とした場合を想定すると、スケールの変化が生じた場合には下記の通り、圧力損失は同等のまま、ドラフト力の増加と初期流れの形成時間の遅れの影響は相殺される方向となる。その結果として、自然対流の安定化までの時間については、PANDA 試験と実機で大きな差異は発生しないものと予想される。</p> <ul style="list-style-type: none"> <li>・ドラフト力=ユニット内外の密度差×ドラフト高さであるため、スケールが大きい実機の方がドラフト高さが大きい分ドラフト力も大きくなり、自然対流の流速が速くなる。</li> <li>・圧力損失=抵抗係数×動圧であり、抵抗係数はスケールに影響しないために、流速が一定であれば圧力損失はスケールが変化しても変わらない。</li> <li>・ユニット外から内への初期の流れの形成は、ユニット内の容積とユニットの除熱能力に主として影響されるが、容積はスケールの三乗に比例するのに対して、除熱能力（伝熱面積）は二乗に比例するために、流速一定であればスケールが大きい実機の方が初期の流れの形成については時間を要する傾向となる。</li> </ul>	<p>3. PANDA 試験と実機条件との比較</p> <p>PANDA 試験のクーラモデルと実機再循環ユニットのダクト系を含めた形状は、それぞれ図1及び参考資料0の図1-2に示すようにほぼ同様（相似）な形状をしており、実機の方が大型である。</p> <p>一方、自然対流の流れの安定化には、主としてドラフト力と圧力損失、ユニット外からユニット内への初期流れの形成が影響するものと考えられる。ここで、ユニットの単位除熱能力（単位通過面積当たりの除熱量、及び単位流速を流した場合のコイル前後の温度（密度）変化量）が同様とした場合を想定すると、スケールの変化が生じた場合には下記の通り、圧力損失は同等のまま、ドラフト力の増加と初期流れの形成時間の遅れの影響は相殺される方向となる。その結果として、自然対流の安定化までの時間については、PANDA 試験と実機で大きな差異は発生しないものと予想される。</p> <ul style="list-style-type: none"> <li>・ドラフト力=ユニット内外の密度差×ドラフト高さであるため、スケールが大きい実機の方がドラフト高さが大きい分ドラフト力も大きくなり、自然対流の流速が速くなる。</li> <li>・圧力損失=抵抗係数×動圧であり、抵抗係数はスケールに影響しないために、流速が一定であれば圧力損失はスケールが変化しても変わらない。</li> <li>・ユニット外から内への初期の流れの形成は、ユニット内の容積とユニットの除熱能力に主として影響されるが、容積はスケールの三乗に比例するのに対して、除熱能力（伝熱面積）は二乗に比例するために、流速一定であればスケールが大きい実機の方が初期の流れの形成については時間を要する傾向となる。</li> </ul>	

赤字：設備、運用又は体制の相違（設計方針の相違）  
 青字：記載箇所又は記載内容の相違（記載方針の相違）  
 緑字：記載表現、設備名称の相違（実質的な相違なし）

第50条 原子炉格納容器の過圧破損を防止するための設備

大飯発電所3 / 4号炉	泊発電所3号炉	相違理由
<p>4. まとめ</p> <p>PANDA 試験の試験前解析の結果では、自然対流冷却の除熱量はクーラ作動から 200 秒程度で安定化し、また、対応する実際の PANDA 試験結果においても 1000 秒程で安定化している。さらに、実炉解析では、15 秒程度で流れが形成され、300 秒程度で流れが安定化する結果が得られている。</p> <p>安定化した状態においては、クーラ周囲の流れはクーラ入口から水平に侵入し、クーラ内で下降流となって下部ダクトを降下してダクト下部から排出する流れが形成される。また、クーラ入口の流速分布は入口上部ほど高速の流線を示し、クーラ下部では流れの一部が正面からクーラ外側へ下降流となって流出している。クーラ周囲の温度分布、水蒸気モル分布はクーラ内部、ダクト内部が容器内と比較して冷却され、水蒸気の割合が低下している。クーラ下部については冷却空気が滞留し、滞留空気の一部がクーラ下部から直接外側へ流出する。これらの流況は、PANDA 試験解析、実炉解析の結果において確認できている。</p> <p>以上より、格納容器再循環ユニットによる自然対流発生のプロセスについて、再循環ユニットが冷却に寄与し始める初期状態から約十数分以内に、ユニット外側からダクトへの下降流が発生し定常的な自然対流冷却状態に至ることが、PANDA 試験と試験前解析及び実炉解析の条件下において定量的に確認されていると言える。</p> <p>実機の格納容器再循環ユニットは、PANDA 試験等のクーラと基本的な構造、仕組みは類似（形状は相似）していることから、実機において上記の知見と大きく異なる挙動が発生することは考え難い。しかしながら、PANDA 試験モデル及び条件と実機では詳細が異なることが予想されることから、初期状態から自然対流冷却安定化までの時間やそれが有効性評価に与える影響については定量的に把握しておくことが重要である。そのために、今後、PANDA 試験の詳細な試験結果を含めたデータの分析を行うこと等により知見の拡充を図り、引き続き実機での挙動を定量的に分析することとする。</p> <p style="text-align: right;">以上</p>	<p>4. まとめ</p> <p>PANDA 試験の試験前解析の結果では、自然対流冷却の除熱量はクーラ作動から 200 秒程度で安定化し、また、対応する実際の PANDA 試験結果においても 1000 秒程で安定化している。さらに、実炉解析では、15 秒程度で流れが形成され、300 秒程度で流れが安定化する結果が得られている。</p> <p>安定化した状態においては、クーラ周囲の流れはクーラ入口から水平に侵入し、クーラ内で下降流となって下部ダクトを降下してダクト下部から排出する流れが形成される。また、クーラ入口の流速分布は入口上部ほど高速の流線を示し、クーラ下部では流れの一部が正面からクーラ外側へ下降流となって流出している。クーラ周囲の温度分布、水蒸気モル分布はクーラ内部、ダクト内部が容器内と比較して冷却され、水蒸気の割合が低下している。クーラ下部については冷却空気が滞留し、滞留空気の一部がクーラ下部から直接外側へ流出する。これらの流況は、PANDA 試験解析、実炉解析の結果において確認できている。</p> <p>以上より、格納容器再循環ユニットによる自然対流発生のプロセスについて、再循環ユニットが冷却に寄与し始める初期状態から約十数分以内に、ユニット外側からダクトへの下降流が発生し定常的な自然対流冷却状態に至ることが、PANDA 試験の試験前解析及び実炉解析の結果から定量的に確認されていると言える。</p> <p>実機の格納容器再循環ユニットは、PANDA 試験等のクーラと基本的な構造、仕組みは類似（形状は相似）していることから、実機において上記の知見と大きく異なる挙動が発生することは考え難い。しかしながら、PANDA 試験モデル及び条件と実機では詳細が異なることが予想されることから、初期状態から自然対流冷却安定化までの時間やそれが有効性評価に与える影響については定量的に把握しておくことが重要である。そのために、今後、PANDA 試験の詳細な試験結果を含めたデータの分析を行うこと等により知見の拡充を図り、引き続き実機での挙動を定量的に分析することとする。</p> <p style="text-align: right;">以上</p>	

赤字：設備、運用又は体制の相違（設計方針の相違）  
 青字：記載箇所又は記載内容の相違（記載方針の相違）  
 緑字：記載表現、設備名称の相違（実質的な相違なし）

第50条 原子炉格納容器の過圧破損を防止するための設備

大飯発電所3 / 4号炉	泊発電所3号炉	相違理由
<p style="text-align: center;">参考文献</p> <p>1. Evaluation of the Cooling Performance of Non Safety Grade Air Recirculation System Cooling Coils (JAERI-memo 08-127, June 1996, "PROCEEDINGS OF THE WORKSHOP ON SEVERE ACCIDENT RESEARCH IN JAPAN (SARJ・95) December 4-6, 1995, Tokyo Japan")</p> <p>2. Ralf Kapulla, Guillaume Mignot, and Domenico Paladino, "Large-Scale Containment Cooler Performance Experiments under Accident Conditions", Hindawi Publishing Corporation Science and Technology of Nuclear Installations Volume 2012, Article ID 943197, 20 pages</p> <p>3. アクシデントマネジメント知識ベース整備に関する報告書（格納容器内多次元流動解析手法の検証と自然対流冷却AM策への適用）(H17～H19年度) 独立行政法人 原子力安全基盤機構事業成果報告書</p> <p>4. アクシデントマネジメント時格納容器内多次元熱流動及びFP挙動解析(H20～H21年度)独立行政法人 原子力安全基盤機構 事業成果報告書</p>	<p style="text-align: center;">参考文献</p> <p>1. Evaluation of the Cooling Performance of Non Safety Grade Air Recirculation System Cooling Coils (JAERI-memo 08-127, June 1996, "PROCEEDINGS OF THE WORKSHOP ON SEVERE ACCIDENT RESEARCH IN JAPAN (SARJ・95) December 4-6, 1995, Tokyo Japan")</p> <p>2. Ralf Kapulla, Guillaume Mignot, and Domenico Paladino, "Large-Scale Containment Cooler Performance Experiments under Accident Conditions", Hindawi Publishing Corporation Science and Technology of Nuclear Installations Volume 2012, Article ID 943197, 20 pages</p> <p>3. アクシデントマネジメント知識ベース整備に関する報告書（格納容器内多次元流動解析手法の検証と自然対流冷却AM策への適用）(H17～H19年度) 独立行政法人 原子力安全基盤機構 事業成果報告書</p> <p>4. アクシデントマネジメント時格納容器内多次元熱流動及びFP挙動解析（H20～H21年度）独立行政法人 原子力安全基盤機構 事業成果報告書</p>	

赤字：設備、運用又は体制の相違（設計方針の相違）  
 青字：記載箇所又は記載内容の相違（記載方針の相違）  
 緑字：記載表現、設備名称の相違（実質的な相違なし）

第50条 原子炉格納容器の過圧破損を防止するための設備

大飯発電所3/4号炉	泊発電所3号炉	相違理由
<p>参考資料-9 格納容器再循環ユニットラフフィルタ撤去による影響について</p> <p>1. 格納容器再循環ユニットラフフィルタの機能                      換気空調設備においては、コイルの上流側にコイルの汚れによる伝熱性能低下を考慮して基本的にコイル上流側にラフフィルタを設置しており、格納容器再循環ユニットも冷却コイルの前面にラフフィルタを設置している。</p> <p>2. 格納容器再循環ユニットラフフィルタ撤去による影響                      添付に<b>大飯3/4号機</b>の格納容器再循環ユニットラフフィルタの差圧データを示す。当該フィルタの差圧上昇はほとんどなく、空気の清浄度は良いと判断でき、格納容器再循環ユニットにフィルタがなくても問題はない。</p> <p>一方、重大事故時においては、エアロゾル発生による悪影響が懸念されるが、自然対流冷却開始時点ではエアロゾルはCVスプレーにより除去できるため、格納容器内に有意なエアロゾルの浮遊はないことから、格納容器再循環ユニットによる自然対流冷却について、エアロゾルによる有意な除熱性能劣化の影響はない。(参考資料-2参照)</p> <p>3. まとめ  <b>大飯3/4号機</b>の格納容器再循環ユニットに内蔵している<b>ラフフィルタ</b>は、冷却コイルの汚れによる伝熱性能低下を防止する目的で設置しているが、これまでフィルタ差圧の上昇はほとんど無く、<b>ラフフィルタ</b>がなくても問題ないと判断できる。</p> <p>また、重大事故時においても自然対流冷却開始時点では格納容器内に有意なエアロゾルの浮遊はないため、エアロゾルによる有意な除熱性能劣化の影響はない。従って、格納容器再循環ユニットの<b>ラフフィルタ</b>の撤去による悪影響はない。</p> <p style="text-align: right;">以上</p>	<p>参考資料-9 格納容器再循環ユニット粗フィルタ撤去による影響について</p> <p>1. 格納容器再循環ユニット粗フィルタの機能                      換気空調設備においては、コイルの上流側にコイルの汚れによる伝熱性能低下を考慮して基本的にコイル上流側にラフフィルタを設置しており、格納容器再循環ユニットも冷却コイルの前面に粗フィルタを設置している。</p> <p>2. 格納容器再循環ユニット粗フィルタ撤去による影響  <b>泊3号炉</b>の格納容器再循環ユニット粗フィルタは294Paの差圧を目安に交換をする運用をしているが、2009年12月の運転開始以来、フィルタ交換の実績はない。</p> <p>また、同様の仕様のフィルタ、フィルタユニットの1、2号炉については、既に2000年よりプラント運転中D号機の粗フィルタを撤去した運用を行っているが、4定検に1度の目視点検においても、ユニットのコイルが汚れるような現象は見られていない。</p> <p>以上より、プラント運転中の格納容器内雰囲気空気の清浄度は良いと判断でき、格納容器再循環ユニットにフィルタがなくても問題はない。</p> <p>一方、重大事故時においては、エアロゾル発生による悪影響が懸念されるが、自然対流冷却開始時点ではエアロゾルはCVスプレーにより除去できるため、格納容器内に有意なエアロゾルの浮遊はないことから、格納容器再循環ユニットによる自然対流冷却について、エアロゾルによる有意な除熱性能劣化の影響はない。(参考資料-2参照)</p> <p>3. まとめ  <b>泊3号炉</b>の格納容器再循環ユニットに内蔵している<b>粗フィルタ</b>は、冷却コイルの汚れによる伝熱性能低下を防止する目的で設置しているが、これまでフィルタ差圧の上昇はほとんど無く、<b>粗フィルタ</b>がなくても問題ないと判断できる。</p> <p>また、重大事故時においても自然対流冷却開始時点では格納容器内に有意なエアロゾルの浮遊はないため、エアロゾルによる有意な除熱性能劣化の影響はない。従って、格納容器再循環ユニットの<b>粗フィルタ</b>の撤去による悪影響はない。</p> <p style="text-align: right;">以上</p>	<p>相違理由</p> <p><u>記載方針の相違</u>                      ・大飯は差圧データを添付しているが、泊3号では実績値が少ないため、環境条件が同等と考える泊1,2号の状況を補足記載している。</p> <p><u>設備名称の相違</u></p>

赤字：設備、運用又は体制の相違（設計方針の相違）  
 青字：記載箇所又は記載内容の相違（記載方針の相違）  
 緑字：記載表現、設備名称の相違（実質的な相違なし）

第50条 原子炉格納容器の過圧破損を防止するための設備

大飯発電所3/4号炉	泊発電所3号炉	相違理由																																																																																				
<p style="text-align: center;">添付</p> <div style="border: 2px solid blue; padding: 10px; margin: 10px auto; width: fit-content;"> <p style="text-align: center;">大飯3/4号機格納容器再循環ユニットラフフィルタの差圧実績</p> <table border="1" style="width: 100%; border-collapse: collapse; text-align: center;"> <thead> <tr> <th rowspan="2">定検回数</th> <th colspan="4">ラフフィルタ差圧[Pa]</th> </tr> <tr> <th>3号機A</th> <th>3号機D</th> <th>4号機A</th> <th>4号機D</th> </tr> </thead> <tbody> <tr><td>1</td><td>220</td><td>220</td><td>205</td><td>235</td></tr> <tr><td>2</td><td>215</td><td>210</td><td>215</td><td>235</td></tr> <tr><td>3</td><td>215</td><td>205</td><td>220</td><td>230</td></tr> <tr><td>4</td><td>225</td><td>215</td><td>225</td><td>230</td></tr> <tr><td>5</td><td>225</td><td>215</td><td>235</td><td>240</td></tr> <tr><td>6</td><td>230</td><td>215</td><td>250</td><td>238</td></tr> <tr><td>7</td><td>235</td><td>220</td><td>260</td><td>240</td></tr> <tr><td>8</td><td>235</td><td>235</td><td>210(交換)</td><td>210(交換)</td></tr> <tr><td>9</td><td>250</td><td>240</td><td>220</td><td>220</td></tr> <tr><td>10</td><td>205(交換)</td><td>220(交換)</td><td>200</td><td>220</td></tr> <tr><td>11</td><td>205</td><td>210</td><td>210</td><td>230</td></tr> <tr><td>12</td><td>215</td><td>225</td><td>215</td><td>240</td></tr> <tr><td>13</td><td>220</td><td>230</td><td>225</td><td>240</td></tr> <tr><td>14</td><td>220</td><td>235</td><td>235</td><td>240</td></tr> <tr><td>15</td><td>230</td><td>235</td><td></td><td></td></tr> </tbody> </table> <p>フィルタ交換目安：290Pa</p> </div> <p style="text-align: center;">48-8-83</p>	定検回数	ラフフィルタ差圧[Pa]				3号機A	3号機D	4号機A	4号機D	1	220	220	205	235	2	215	210	215	235	3	215	205	220	230	4	225	215	225	230	5	225	215	235	240	6	230	215	250	238	7	235	220	260	240	8	235	235	210(交換)	210(交換)	9	250	240	220	220	10	205(交換)	220(交換)	200	220	11	205	210	210	230	12	215	225	215	240	13	220	230	225	240	14	220	235	235	240	15	230	235				<p style="color: blue;">記載方針の相違</p>
定検回数		ラフフィルタ差圧[Pa]																																																																																				
	3号機A	3号機D	4号機A	4号機D																																																																																		
1	220	220	205	235																																																																																		
2	215	210	215	235																																																																																		
3	215	205	220	230																																																																																		
4	225	215	225	230																																																																																		
5	225	215	235	240																																																																																		
6	230	215	250	238																																																																																		
7	235	220	260	240																																																																																		
8	235	235	210(交換)	210(交換)																																																																																		
9	250	240	220	220																																																																																		
10	205(交換)	220(交換)	200	220																																																																																		
11	205	210	210	230																																																																																		
12	215	225	215	240																																																																																		
13	220	230	225	240																																																																																		
14	220	235	235	240																																																																																		
15	230	235																																																																																				

泊発電所3号炉審査資料	
資料番号	SA51H-9 r.4.0
提出年月日	令和5年8月31日

## 泊発電所3号炉

設置許可基準規則等への適合状況について  
(重大事故等対処設備)  
補足説明資料  
比較表

51条

令和5年8月  
北海道電力株式会社

枠囲みの内容は機密情報に属しますので公開できません。

赤字：設備、運用又は体制の相違（設計方針の相違）  
 青字：記載箇所又は記載内容の相違（記載方針の相違）  
 緑字：記載表現、設備名称の相違（実質的な相違なし）

第51条 原子炉冷却材圧力バウンダリ高圧時に発電用原子炉を冷却するための設備

大飯発電所3 / 4号炉	泊発電所3号炉	相違理由
--------------	---------	------

補足資料のうちSA基準適合性一覧表および関連資料の相違箇所に対する考え方について

「SA基準適合性一覧表」およびその適合性を確認するための「関連資料」について、大飯との比較による相違箇所について類型化し考え方を整理し、整理した結果をそれぞれ「適合性一覧表の相違箇所について」及び「関連資料の相違箇所について」に示す。

**【適合性一覧表の相違箇所について】**

- 43条のSA設備要求事項に対する適合性について、大飯との適合性一覧表における記述の比較結果および相違に対する設計方針の相違有無については表-1の通り。
- 記述内容は相違しているが、類型化にて整理した結果を記載していること、適合するための設計を行う方針であることについて相違はない。
- 類型化の整理結果は相違するものの、類型化に従った適合方針について記載したまとめ資料本文にて比較しているため、本資料(比較表)では相違箇所の識別のみとする。

**【関連資料の相違箇所について】**

- 43条の要求事項に対する設計方針を補足する関連資料について、大飯および女川との比較により相違する項目、関連資料および相違理由については表-2の通り。
- 適合性一覧にて示している関連資料において記載事項は異なるが、いずれかの資料にて適合状況の確認が可能な記述があることを確認している。
- よって、表-2の整理結果との紐付け記号をSA基準適合性一覧表の比較表に記載するのみのとする。

表-1

各設備の適合性における相違箇所に対する考え方 【 いずれも43条適合方針について大飯、女川との相違なし】		
記号	相違のある要求事項	相違に対する考え方
①	環境条件_環境影響	配置設計により設置環境として考慮すべき事項は相違するが、設置環境での環境影響を考慮した設計とする方針に相違なし
②	環境条件_海水通水	外部造水系(補給・除熱除く)は水源として海を用いるため海水影響を考慮する方針に相違なし 常設設備への接続系統は相違するが、海水通水の影響を考慮した設計とする方針に相違なし
③	操作性	操作対象とする設備により遠隔操作・現場操作(又は両方)が相違するが、遠隔操作および現場操作が可能とする方針に相違なし
④	切り替え性	本来用途と異なる目的にて使用するための操作を切り替え性とする(本来用途のための操作は操作性にて考慮)か、SA時の操作全般を切り替え性とするかの相違はあるが、いずれも操作可能とする方針に相違なし
⑤	悪影響防止_系統設計	系統操作について④にて操作性又は切り替え性としての適合方針の相違により、同一の操作であっても系統操作の類型化が異なる。悪影響を与えないための類型化分類化相違するが、対象とする系統へ悪影響を与えないための方針に相違なし
⑥	設置場所	対象設備の相違により操作場所が相違するが対象設備の操作場所に応じた放射線防護を取る方針に相違なし
⑦	容量等	有効性評価等による必要容量は相違するが、必要容量を賅える容量とする方針に相違なし
⑧	共通要因故障防止_自然現象・外部人為事象	設置場所により考慮する共通要因及び同時故障を防止する対象設備が相違するが、想定する共通要因及び対象設備に対し多重性及び独立性又は多様性を有する設計とし、位置的分散を図る方針に相違なし
⑨	共通要因故障_サポート系	対象設備によりサポート系の要・不要は相違するが、異なる駆動源を有する設計とする方針に相違なし

表-2

記号	43条適合性確認項目	関連資料			大飯との相違理由
		【大飯】	【泊】	【女川】(参考)	
①	環境条件における健全性	配置図	配置図(保管場所図) 系統図 接続図	配置図(保管場所図) 系統図 接続図	泊では目的別に資料を構成していることにより、紐付けている関連資料は異なるが、適合性を補足する資料として相違なし
②	操作性	配置図	配置図 系統図 接続図	接続図 配置図	泊では目的別に資料を構成していることにより、紐付けている関連資料は異なるが、適合性を補足する資料として相違なし
③	試験・検査	構造図 試験検査説明資料 設備概要 ブロック図、他	試験・検査説明資料	試験及び検査	大飯では試験・検査説明資料に記載している個別資料の名称を記載しているものであり、資料自体の相違なし
④	切り替え性	系統図 配置図	系統図	系統図	大飯では配置図を関連資料とし、配置図においては操作性の確実性について示されている 配置図における情報量は相違はなく、各設備の操作性の確実性については操作性における確認事項であるため紐付ける必要はないと判断している
⑤	悪影響防止	系統図 配置図	系統図 配置図(保管場所図) 試験・検査説明資料	系統図 試験及び検査	泊では試験・検査説明資料を関連資料としている 試験・検査説明資料は、設備の構造上の観点にて周辺への悪影響がないことを補足するため紐付けているものである
⑥	設置場所	配置図	接続図 配置図	接続図 配置図	泊では目的別に資料を構成していることにより、紐付けている関連資料は異なるが、適合性を補足する資料として相違なし
⑦	容量(常設、可搬)	容量設定根拠	容量設定根拠	容量設定根拠	資料の内容については設計連携により相違しているが、適合性を補足する資料として相違なし
—	共用の禁止	—	—	—	—(単号炉申請であり共用設備なし)
⑧	共通要因故障防止(常設)	配置図 系統図 設備概要	配置図 系統図 単線結線図 その他補足資料	配置図 系統図 単線結線図	記載表現の相違、内容に相違なし 大飯では設備概要を関連資料としているが、当該要求事項において適合性を補足する資料として充足していることより紐付けていない なお設備概要における記載内容は相違なし
⑨	接続性	系統図	接続図	接続図	紐付けている資料は異なるが、当該要求事項に対する適合性の補足資料として記述内容に相違なし
⑩	異なる複数の接続箇所	配置図	接続図	接続図	
⑪	設置場所	配置図	接続図	接続図	
⑫	保管場所	配置図	保管場所図	保管場所図	紐付けている資料は異なるが、当該要求事項に対する適合性の補足資料として記述内容に相違なし
⑬	アクセスルート	補足説明資料共通4	アクセスルート	アクセスルート図	
⑭	共通要因故障防止(可搬)	配置図 系統図 設備概要	配置図 保管場所図 系統図 単線結線図 接続図	配置図 保管場所図 系統図 単線結線図	記載表現の相違、内容に相違なし 大飯では設備概要を関連資料としているが、当該要求事項において適合性を補足する資料として充足していることより紐付けていない なお設備概要における記載内容は相違なし



赤字：設備、運用又は体制の相違（設計方針の相違）  
 青字：記載箇所又は記載内容の相違（記載方針の相違）  
 緑字：記載表現、設備名称の相違（実質的な相違なし）

第51条 原子炉格納容器下部の溶融炉心を冷却するための設備

大飯発電所3/4号炉	泊発電所3号炉	相違理由
<p>設計方針・運用・体制を変更するものではないが、補足資料の記載の充実を行った箇所と理由</p> <p><u>女川2号炉まとめ資料と比較した結果変更したもの</u></p> <p>重大事故等対処設備の手段が類似する「54条_使用済燃料貯蔵槽の冷却等のための設備」の資料比較により、先行審査実績との比較を行い、補足説明資料の資料構成及び資料内の記載内容・情報について、それぞれの資料の記載を充実する事項を抽出し、重大事故等対処設備の手段が相違する条文の補足説明資料についても、同様の視点で資料充実・反映を行いました。</p> <p><b>【共通（資料構成の変更）】</b></p> <ul style="list-style-type: none"> <li>・基準適合性一覧の適合性を確認するための関連資料の種類を次のとおり、女川2号炉と同じ書類構成としました。                  （変更前）配置図、試験検査、系統図、容量設定根拠                  （変更後）配置図、試験検査、系統図、容量設定根拠、単線結線図、接続図、保管場所図、アクセスルート図                  「単線結線図」は、電源設備にて作成していたが、各条にて給電経路を説明するため作成することとしました。                  「接続図、保管場所図、アクセスルート図」は、変更前の配置図他にて同様の情報を扱っていたが、基準適合性をより適切に説明するため作成することとしました。</li> <li>・自主対策設備についての説明資料を新規作成しました。</li> <li>・各資料の比較表を作成し、相違箇所については、本文まとめ資料の比較表を参照して相違理由の記載を充実しました。</li> </ul> <p><b>【配置図】</b></p> <ul style="list-style-type: none"> <li>・新たに作成した「接続図、保管場所図、アクセスルート図」と掲載する情報を区分し、前ページ表2のとおり設置許可基準43条の各項号の確認項目を示す資料を変更しました。                  配置図は、屋内設備の設置・保管場所を示し、環境条件、位置的分散の関連資料であるとともに、操作性、悪影響防止の対応状況を示す写真を掲載しました。</li> <li>・機能喪失を想定する設計基準事故対処設備に加え、重大事故等対処設備が位置的分散を図る対象設備を明示するよう追加しました。</li> <li>・重大事故等対処設備の写真掲載に加え、位置的分散の対象とする設備の写真について追加しました。</li> <li>・操作性を示す関連資料として、操作スイッチ（MCRも）を示す配置図を追加し、操作性が確認できる操作スイッチ等の写真を追加しました。                  また、操作ができることを示すため、現場操作を行う弁について写真を追加しました。</li> </ul> <p><b>【試験検査】</b></p> <ul style="list-style-type: none"> <li>・関連資料が相違する場合には、試験検査ができることを示す関連資料として、適切と判断する理由を相違理由に記載しました。</li> <li>・比較プラントが定期事業者検査実績（検査計画、検査要領書）を関連資料として示す場合であっても、泊3号炉は定期事業者検査の実施回数が少なく検査実績を示せない場合には、設備構造図や系統図等の設計資料を関連資料として揭示し、試験検査ができることを示す比較プラントの関連資料と相違する場合には、相違理由の記載を充実しました。</li> </ul> <p><b>【系統図】</b></p> <ul style="list-style-type: none"> <li>・女川2号炉の系統図様式（操作設備を掲載し、系統図にて対象設備を識別）にて、新たに作成しました。                  なお、屋外・屋内の接続箇所ごとの系統図は作成せず、屋外設備等の複数経路は接続図、アクセスルート図等を関連資料としました。</li> </ul> <p><b>【容量設定根拠】</b></p> <ul style="list-style-type: none"> <li>・建設時に設定根拠説明書を作成したことから変更前後の記載としていましたが、容量仕様は現設計値のみ記載するよう変更しました。</li> <li>・容量等の説明に加え、女川2号炉において補足する資料の有無を確認し、必要な資料を追加しました。</li> </ul> <p><b>【単線結線図、接続図、保管場所図、アクセスルート図】</b></p> <ul style="list-style-type: none"> <li>・従来、複数要求への対応を示す関連資料であった配置図が有する情報について、女川2号炉の資料構成を参照し、新規作成しました。</li> </ul>		

泊発電所3号炉 SA基準適合性 比較表

赤字：設備、運用又は体制の相違（設計方針の相違）  
 青字：記載箇所又は記載内容の相違（記載方針の相違）  
 緑字：記載表現、設備名称の相違（実質的な相違なし）

第51条 原子炉格納容器下部の溶融炉心を冷却するための設備

大飯発電所3/4号炉	泊発電所3号炉	相違理由
<p>51-1 SA設備基準適合性 一覧表</p>	<p>51-1 SA設備 基準適合性一覧表</p>	

赤字：設備、運用又は体制の相違（設計方針の相違）  
 青字：記載箇所又は記載内容の相違（記載方針の相違）  
 緑字：記載表現、設備名称の相違（実質的な相違なし）

大飯発電所3/4号炉		泊発電所3号炉		相違理由
項目	大飯発電所3/4号炉	項目	泊発電所3号炉	
1	原子炉格納容器下部の溶融炉心を冷却するための設備	1	原子炉格納容器下部の溶融炉心を冷却するための設備	
2	格納容器下部の溶融炉心を冷却するための設備	2	格納容器下部の溶融炉心を冷却するための設備	
3	格納容器下部の溶融炉心を冷却するための設備	3	格納容器下部の溶融炉心を冷却するための設備	
4	格納容器下部の溶融炉心を冷却するための設備	4	格納容器下部の溶融炉心を冷却するための設備	
5	格納容器下部の溶融炉心を冷却するための設備	5	格納容器下部の溶融炉心を冷却するための設備	
6	格納容器下部の溶融炉心を冷却するための設備	6	格納容器下部の溶融炉心を冷却するための設備	
7	格納容器下部の溶融炉心を冷却するための設備	7	格納容器下部の溶融炉心を冷却するための設備	
8	格納容器下部の溶融炉心を冷却するための設備	8	格納容器下部の溶融炉心を冷却するための設備	
9	格納容器下部の溶融炉心を冷却するための設備	9	格納容器下部の溶融炉心を冷却するための設備	

51-1-1

泊発電所3号炉 SA設備基準適合性 一覧表(常設)		相違理由
項目	泊発電所3号炉 SA設備基準適合性 一覧表(常設)	
1	格納容器下部の溶融炉心を冷却するための設備	
2	格納容器下部の溶融炉心を冷却するための設備	
3	格納容器下部の溶融炉心を冷却するための設備	
4	格納容器下部の溶融炉心を冷却するための設備	
5	格納容器下部の溶融炉心を冷却するための設備	
6	格納容器下部の溶融炉心を冷却するための設備	
7	格納容器下部の溶融炉心を冷却するための設備	
8	格納容器下部の溶融炉心を冷却するための設備	
9	格納容器下部の溶融炉心を冷却するための設備	

51-1-1





赤字：設備、運用又は体制の相違（設計方針の相違）  
 青字：記載箇所又は記載内容の相違（記載方針の相違）  
 緑字：記載表現、設備名称の相違（実質的な相違なし）

大飯発電所3/4号炉		泊発電所3号炉		相違理由
項目	大飯3、4号炉 SA基準適合性 一覧表	項目	泊発電所3号炉 SA設備基準適合性 一覧表(常設)	
原子炉格納容器下部の溶融炉心を冷却するための設備	① ② ③ ④ ⑤ ⑥ ⑦ ⑧ ⑨	原子炉格納容器下部の溶融炉心を冷却するための設備	① ② ③ ④ ⑤ ⑥ ⑦ ⑧ ⑨	
①	原子炉格納容器下部の溶融炉心を冷却するための設備	①	原子炉格納容器下部の溶融炉心を冷却するための設備	
②	原子炉格納容器下部の溶融炉心を冷却するための設備	②	原子炉格納容器下部の溶融炉心を冷却するための設備	
③	原子炉格納容器下部の溶融炉心を冷却するための設備	③	原子炉格納容器下部の溶融炉心を冷却するための設備	
④	原子炉格納容器下部の溶融炉心を冷却するための設備	④	原子炉格納容器下部の溶融炉心を冷却するための設備	
⑤	原子炉格納容器下部の溶融炉心を冷却するための設備	⑤	原子炉格納容器下部の溶融炉心を冷却するための設備	
⑥	原子炉格納容器下部の溶融炉心を冷却するための設備	⑥	原子炉格納容器下部の溶融炉心を冷却するための設備	
⑦	原子炉格納容器下部の溶融炉心を冷却するための設備	⑦	原子炉格納容器下部の溶融炉心を冷却するための設備	
⑧	原子炉格納容器下部の溶融炉心を冷却するための設備	⑧	原子炉格納容器下部の溶融炉心を冷却するための設備	
⑨	原子炉格納容器下部の溶融炉心を冷却するための設備	⑨	原子炉格納容器下部の溶融炉心を冷却するための設備	

51-1-1





大飯発電所3/4号炉		泊発電所3号炉		相違理由
項目	大飯3、4号炉 SA基準適合性 一覧表	項目	泊発電所3号炉 SA設備基準適合性 一覧表(常設)	
原子炉格納容器下部の溶融炉心を冷却するための設備	① ② ③ ④ ⑤ ⑥ ⑦ ⑧ ⑨	原子炉格納容器下部の溶融炉心を冷却するための設備	① ② ③ ④ ⑤ ⑥ ⑦ ⑧ ⑨	
①	原子炉格納容器下部の溶融炉心を冷却するための設備	①	原子炉格納容器下部の溶融炉心を冷却するための設備	
②	原子炉格納容器下部の溶融炉心を冷却するための設備	②	原子炉格納容器下部の溶融炉心を冷却するための設備	
③	原子炉格納容器下部の溶融炉心を冷却するための設備	③	原子炉格納容器下部の溶融炉心を冷却するための設備	
④	原子炉格納容器下部の溶融炉心を冷却するための設備	④	原子炉格納容器下部の溶融炉心を冷却するための設備	
⑤	原子炉格納容器下部の溶融炉心を冷却するための設備	⑤	原子炉格納容器下部の溶融炉心を冷却するための設備	
⑥	原子炉格納容器下部の溶融炉心を冷却するための設備	⑥	原子炉格納容器下部の溶融炉心を冷却するための設備	
⑦	原子炉格納容器下部の溶融炉心を冷却するための設備	⑦	原子炉格納容器下部の溶融炉心を冷却するための設備	
⑧	原子炉格納容器下部の溶融炉心を冷却するための設備	⑧	原子炉格納容器下部の溶融炉心を冷却するための設備	
⑨	原子炉格納容器下部の溶融炉心を冷却するための設備	⑨	原子炉格納容器下部の溶融炉心を冷却するための設備	

51-1-4



赤字：設備、運用又は体制の相違（設計方針の相違）  
 青字：記載箇所又は記載内容の相違（記載方針の相違）  
 緑字：記載表現、設備名称の相違（実質的な相違なし）

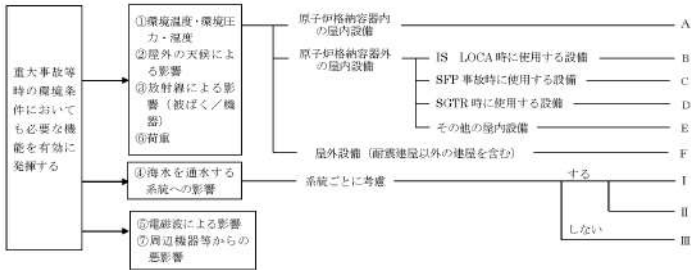
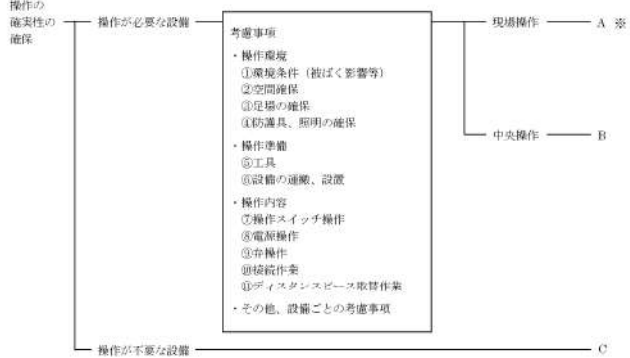
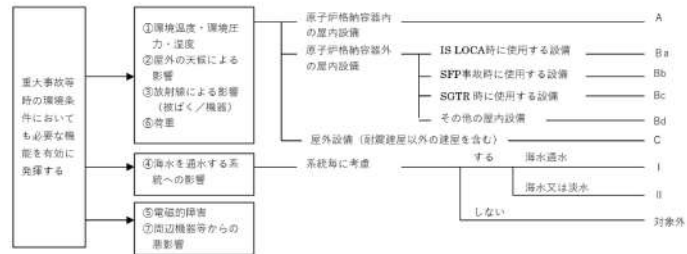

第51条 原子炉格納容器下部の溶融炉心を冷却するための設備

大飯発電所3/4号炉	泊発電所3号炉	相違理由
<p>大飯3、4号炉 SA設備基準適合性一覧表の記号説明</p> <p>■設置許可基準規則 第43条 第1項 第1号 重大事故等時の環境条件における健全性について</p>  <p>④海水を通過する系統については、Ⅰ：通常時に海水を通過する系統、Ⅱ：淡水又は海水から選択できる系統、Ⅲ：海水を通過しない系統で分類する。</p> <p>■設置許可基準規則 第43条 第1項 第2号 操作の確実性について</p>  <p>※：設備ごとに対応の組み合わせが異なるため、その対応を設備ごとに記載する。                  (例：A①、A②、A③等)</p>	<p>泊3号炉 SA設備基準適合性一覧表の記号説明</p> <p>■設置許可基準規則 第43条 第1項 第1号 重大事故等時の環境条件における健全性について</p>  <p>■設置許可基準規則 第43条 第1項 第2号 操作の確実性について</p> 	

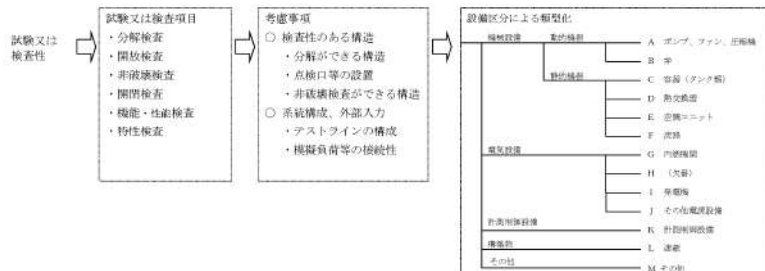
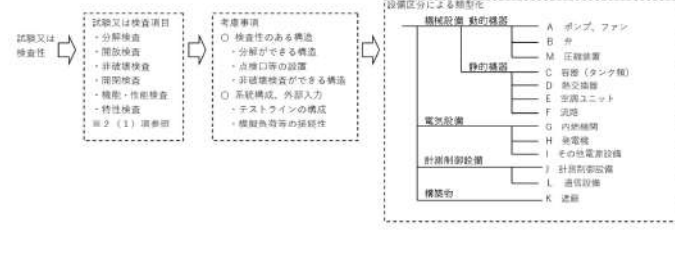
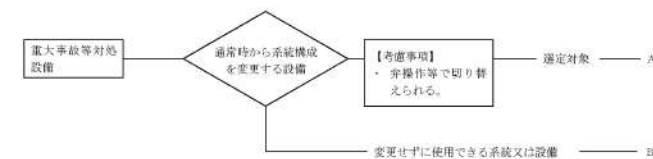

赤字：設備、運用又は体制の相違（設計方針の相違）  
 青字：記載箇所又は記載内容の相違（記載方針の相違）  
 緑字：記載表現、設備名称の相違（実質的な相違なし）

第51条 原子炉格納容器下部の溶融炉心を冷却するための設備

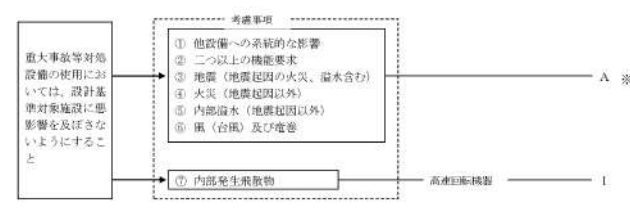
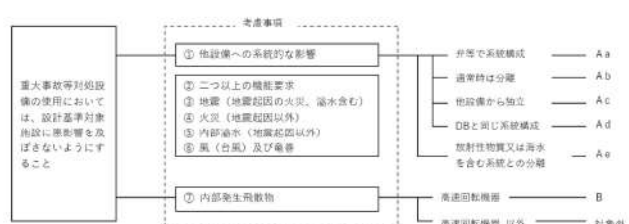
大飯発電所3/4号炉	泊発電所3号炉	相違理由
<p>■設置許可基準規則 第43条 第1項 第3号                      試験又は検査性について</p> 	<p>■設置許可基準規則 第43条 第1項 第3号                      試験又は検査性について</p> 	
<p>■設置許可基準規則 第43条 第1項 第4号                      切り替え性について</p> 	<p>■設置許可基準規則 第43条 第1項 第4号                      切り替え性について</p> 	
<p>■設置許可基準規則 第43条 第1項 第5号                      重大事故等対処設備の悪影響防止について</p>  <p>※：Aについては、Aと考慮事項の番号を記載する。（例：A①、A③等）</p>	<p>■設置許可基準規則 第43条 第1項 第5号                      重大事故等対処設備の悪影響防止について</p> 	

赤字：設備、運用又は体制の相違（設計方針の相違）  
 青字：記載箇所又は記載内容の相違（記載方針の相違）  
 緑字：記載表現、設備名称の相違（実質的な相違なし）

第51条 原子炉格納容器下部の溶融炉心を冷却するための設備

大飯発電所3/4号炉

■設置許可基準規則 第43条 第1項 第6号  
 設置場所について

■設置許可基準規則 第43条 第2項 第1号  
 常設重大事故等対処設備の容量等について

■設置許可基準規則 第43条 第2項 第2号  
 発電用原子炉施設での共用の禁止について

■設置許可基準規則 第43条 第2項 第3号  
 常設重大事故防止設備の共通要因故障について

※：記号の記載については、考慮事項の番号+a又はbを記載する。（例：①a、①b、②a、②b）

泊発電所3号炉

■設置許可基準規則 第43条 第1項 第6号  
 設置場所について

■設置許可基準規則 第43条 第2項 第1号  
 常設重大事故等対処設備の容量等について

■設置許可基準規則 第43条 第2項 第2号  
 発電用原子炉施設での共用の禁止について

区分	設計方針	関連資料	備考
-	2以上の発電用原子炉施設において共用しない設計とする。	-	-

■設置許可基準規則 第43条 第2項 第3号  
 常設重大事故防止設備の共通要因故障について





赤字：設備、運用又は体制の相違（設計方針の相違）  
 青字：記載箇所又は記載内容の相違（記載方針の相違）  
 緑字：記載表現、設備名称の相違（実質的な相違なし）

第51条 原子炉格納容器下部の溶融炉心を冷却するための設備

大飯発電所3/4号炉	泊発電所3号炉	相違理由
<p>■設置許可基準規則 第43条 第3項 第1号 可搬型重大事故等対処設備の容量等について</p> <div data-bbox="246 255 918 510"> <p>【考慮事項】</p> <p>① 原子炉補助建屋の外から水又は電力を供給する設備かどうか</p> <p>② 負荷に直接接続する可搬型直流電源設備、可搬型バッテリー、可搬型ポンプ等かどうか</p> </div> <div data-bbox="515 271 784 510"> <p>原子炉補助建屋の外から水又は電力を供給する可搬型設備 — A</p> <p>負荷に直接接続する可搬型直流電源設備、可搬型バッテリー、可搬型ポンプ等 — B</p> <p>①、②以外 — C</p> <p>予備数量の考え方へ</p> </div> <div data-bbox="246 558 918 798"> <p>【考慮事項】</p> <p>④ プラント定検中等当該可搬型重大事故等対処設備の機能を要求されない時期に保守点検を実施するかどうか</p> <p>⑤ 保守点検中でも使用可能（外観目視、給油・給薬、メガチェック、機能確認、一式取替（点検済みの設備との取替含む。）の際に、事前に取替品を準備してから保守点検するかどうか等）であるかどうか</p> </div> <div data-bbox="582 558 873 798"> <p>プラント定検中等当該可搬型重大事故等対処設備の機能を要求されない時期に保守点検を実施する設備 — a</p> <p>保守点検中でも使用可能（外観目視、給油・給薬、メガチェック、機能確認等一式取替（点検済みの設備との取替含む。）の際に、事前に取替品を準備してから保守点検するかどうか等）である設備 — b</p> <p>④、⑤以外 — c</p> </div>	<p>■設置許可基準規則 第43条 第3項 第1号 可搬型重大事故等対処設備の容量等について</p> <div data-bbox="1164 255 1836 430"> <p>【考慮事項】</p> <p>① 原子炉建屋又は原子炉補助建屋の外から水又は電力を供給する設備かどうか</p> <p>② 負荷に直接接続する可搬型バッテリー及び可搬型ポンプ等かどうか</p> </div> <div data-bbox="1456 255 1724 430"> <p>原子炉建屋又は原子炉補助建屋の外から水又は電力を供給する可搬型設備 — A</p> <p>負荷に直接接続する可搬型バッテリー及び可搬型ポンプ等 — B</p> <p>①、②以外 — C</p> <p>予備数量も含めて設計方針とする。</p> </div>	
<p>■設置許可基準規則 第43条 第3項 第2号 可搬型重大事故等対処設備の常設設備との接続性について</p> <div data-bbox="268 893 896 1133"> <p>【考慮事項】</p> <p>① 容易かつ確実な接続</p> <p>② 接続部の規格の統一</p> </div> <div data-bbox="560 893 896 1133"> <p>ケーブル</p> <p>コネクタ接続 — A</p> <p>より簡便な接続規格等による接続 — C</p> <p>配管</p> <p>ボルト締フランジ接続 — B</p> <p>より簡便な接続規格等による接続 — C</p> <p>その他の措置 — D</p> <p>接続なし — E</p> </div>	<p>■設置許可基準規則 第43条 第3項 第2号 可搬型重大事故等対処設備の常設設備との接続性について</p> <div data-bbox="1187 893 1814 1133"> <p>【考慮事項】</p> <p>① 容易かつ確実な接続</p> <p>② 接続部の規格の統一</p> </div> <div data-bbox="1456 893 1814 1133"> <p>ケーブル</p> <p>母線供給</p> <p>端子のボルト・ネジによる接続 — A</p> <p>通信・計装各設備電源</p> <p>専用の接続方法による接続 — D</p> <p>水・空気配管</p> <p>大口径等</p> <p>ボルト締フランジ接続 — B</p> <p>小口径等</p> <p>より簡便な接続規格等による接続 — C</p> <p>油配管、計装付属配管</p> <p>専用の接続方法による接続 — D</p> </div>	
<p>■設置許可基準規則 第43条 第3項 第3号 異なる複数の接続箇所の確保について</p> <div data-bbox="268 1212 896 1420"> <p>【考慮事項】</p> <p>・放射線による影響因子</p> <p>・漏水、火災</p> <p>・自然現象</p> <p>・外部人為事象</p> </div> <div data-bbox="515 1212 896 1420"> <p>水・電力</p> <p>屋内（壁面含む） — A</p> <p>屋内及び屋外 — B</p> <p>その他（空気） — C</p> <p>接続箇所なし — D</p> </div>		

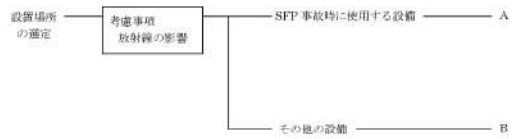
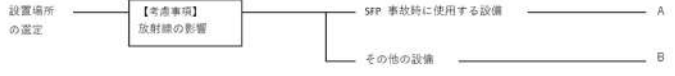
赤字：設備、運用又は体制の相違（設計方針の相違）  
 青字：記載箇所又は記載内容の相違（記載方針の相違）  
 緑字：記載表現、設備名称の相違（実質的な相違なし）

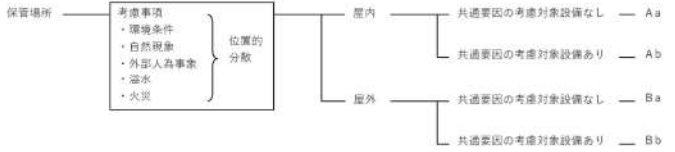
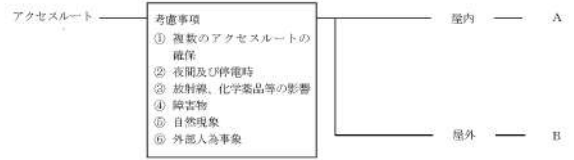
第51条 原子炉格納容器下部の溶融炉心を冷却するための設備

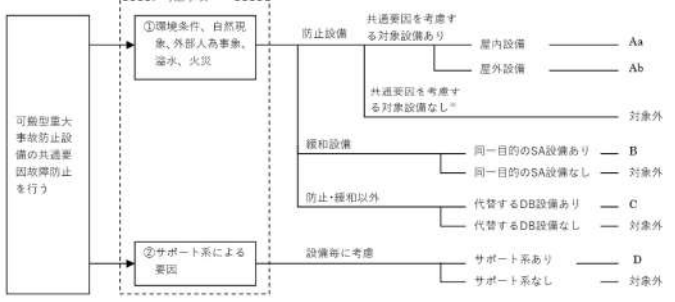
大飯発電所3/4号炉	泊発電所3号炉	相違理由
<p>■設置許可基準規則 第43条 第3項 第4号 可搬型重大事故等対処設備の設置場所について</p> 	<p>■設置許可基準規則 第43条 第3項 第4号 可搬型重大事故等対処設備の設置場所について</p> 	
<p>■設置許可基準規則 第43条 第3項 第5号 保管場所について</p> 	<p>■設置許可基準規則 第43条 第3項 第5号 保管場所について</p> 	
<p>■設置許可基準規則 第43条 第3項 第6号 アクセスルートについて</p> 	<p>■設置許可基準規則 第43条 第3項 第6号 アクセスルートについて</p> 	
<p>■設置許可基準規則 第43条 第3項 第7号 重大事故防止設備のうちの可搬型のものの共通要因故障について</p>  <p>※：記号の記載については、考慮事項の番号+a又はbを記載する。(例：①a、①b、②a、②b)</p>	<p>■設置許可基準規則 第43条 第3項 第7号 重大事故防止設備のうちの可搬型のものの共通要因故障について</p> 	

泊発電所3号炉 SA基準適合性 比較表

赤字：設備、運用又は体制の相違（設計方針の相違）  
 青字：記載箇所又は記載内容の相違（記載方針の相違）  
 緑字：記載表現、設備名称の相違（実質的な相違なし）

第51条 原子炉格納容器下部の溶融炉心を冷却するための設備

大飯発電所3/4号炉	泊発電所3号炉	相違理由
<p style="text-align: center;">51-2 配置図 3号炉</p>	<p style="text-align: center;">51-2 配置図</p> <div style="border: 1px solid black; padding: 5px; margin-top: 20px;"> <p>凡例</p> <p><span style="border: 1px solid blue; display: inline-block; width: 15px; height: 10px; vertical-align: middle;"></span>：設計基準対象施設</p> <p><span style="border: 1px solid red; display: inline-block; width: 15px; height: 10px; vertical-align: middle;"></span>：重大事故等対処設備</p> </div>	<p>・設備の相違、配置箇所 の相違により、比較対象資料は一致せず。</p> <p>・SA基準適合性一覧表に取りまとめた内容に対して、設備の設置、保管場所を示すとともに環境条件、位置的分散、操作性および悪影響防止等の適合性を確認するための資料構成に相違なし（以降、配置図において相違理由省略）</p>

赤字：設備、運用又は体制の相違（設計方針の相違）  
 青字：記載箇所又は記載内容の相違（記載方針の相違）  
 緑字：記載表現、設備名称の相違（実質的な相違なし）

第51条 原子炉格納容器下部の溶融炉心を冷却するための設備

大飯発電所3/4号炉	泊発電所3号炉	相違理由
<div data-bbox="190 191 1008 1356" style="border: 2px solid black; height: 730px; width: 365px;"></div> <div data-bbox="190 1356 705 1385" style="border: 1px solid black; padding: 2px;">                     枠囲みの範囲は機密に係る事項ですので公開することはできません。                 </div> <div data-bbox="952 1380 1019 1404" style="text-align: right;">                     51-2-2                 </div>	<div data-bbox="1176 343 1859 1260" style="text-align: center;"> </div> <div data-bbox="1276 1332 1736 1364" style="text-align: center;">                     図51-2-1 配置図（原子炉格納容器下部への注水）                 </div> <div data-bbox="1467 1364 1534 1388" style="text-align: center;">                     51-2-1                 </div>	

赤字：設備、運用又は体制の相違（設計方針の相違）  
 青字：記載箇所又は記載内容の相違（記載方針の相違）  
 緑字：記載表現、設備名称の相違（実質的な相違なし）

第51条 原子炉格納容器下部の溶融炉心を冷却するための設備

大飯発電所3/4号炉	泊発電所3号炉	相違理由
<div data-bbox="183 199 1003 1359" style="border: 2px solid black; height: 727px; width: 366px;"></div> <div data-bbox="183 1364 703 1396" style="border: 1px solid black; padding: 2px;">                     枠囲みの範囲は機密に係る事項ですので公開することはできません。                 </div> <div data-bbox="958 1380 1019 1404" style="text-align: right;">                     51-2-3                 </div>	<div data-bbox="1108 215 1870 1268" style="text-align: center;"> </div> <div data-bbox="1288 1332 1736 1364" style="text-align: center;">                     図51-2-2 配置図（原子炉格納容器下部への注水）                 </div> <div data-bbox="1478 1364 1534 1388" style="text-align: center;">                     51-2-2                 </div>	

赤字：設備、運用又は体制の相違（設計方針の相違）  
 青字：記載箇所又は記載内容の相違（記載方針の相違）  
 緑字：記載表現、設備名称の相違（実質的な相違なし）

第51条 原子炉格納容器下部の溶融炉心を冷却するための設備

大飯発電所3/4号炉	泊発電所3号炉	相違理由
<div data-bbox="190 199 1008 1356" style="border: 2px solid black; height: 725px; width: 365px;"></div> <div data-bbox="190 1364 705 1396" style="border: 1px solid black; padding: 2px;">                     枠囲みの範囲は機密に係る事項ですので公開することはできません。                 </div> <div data-bbox="952 1380 1019 1404" style="text-align: right;">                     51-2-4                 </div>	<div data-bbox="1120 215 1915 1101" style="text-align: center;"> </div> <div data-bbox="1288 1332 1736 1364" style="text-align: center;">                     図51-2-3 配置図（原子炉格納容器下部への注水）                 </div> <div data-bbox="1478 1364 1545 1388" style="text-align: center;">                     51-2-3                 </div>	



赤字：設備、運用又は体制の相違（設計方針の相違）  
 青字：記載箇所又は記載内容の相違（記載方針の相違）  
 緑字：記載表現、設備名称の相違（実質的な相違なし）

第51条 原子炉格納容器下部の溶融炉心を冷却するための設備

大飯発電所3/4号炉	泊発電所3号炉	相違理由
<div data-bbox="190 199 1008 1356" style="border: 2px solid black; height: 725px; width: 365px;"></div> <div data-bbox="190 1364 705 1396" style="border: 1px solid black; padding: 2px;">                     枠囲みの範囲は機密に係る事項ですので公開することはできません。                 </div> <div data-bbox="952 1380 1019 1404" style="text-align: right;">                     51-2-5                 </div>	<div data-bbox="1120 375 1870 1228" style="text-align: center;"> </div> <div data-bbox="1276 1332 1736 1364" style="text-align: center;">                     図51-2-4 配置図（原子炉格納容器下部への注水）                 </div> <div data-bbox="1467 1364 1534 1388" style="text-align: center;">                     51-2-4                 </div>	

泊発電所3号炉 SA基準適合性 比較表

赤字：設備、運用又は体制の相違（設計方針の相違）  
 青字：記載箇所又は記載内容の相違（記載方針の相違）  
 緑字：記載表現、設備名称の相違（実質的な相違なし）

第51条 原子炉格納容器下部の溶融炉心を冷却するための設備

大飯発電所3/4号炉	泊発電所3号炉	相違理由
<p>51-4 試験・検査説明資料 3号炉</p>	<p>51-3 試験・検査説明資料</p>	

赤字：設備、運用又は体制の相違（設計方針の相違）  
 青字：記載箇所又は記載内容の相違（記載方針の相違）  
 緑字：記載表現、設備名称の相違（実質的な相違なし）

大飯発電所3/4号炉		泊発電所3号炉		相違理由	
機器又は系統名	実名称(機器名)	点検及び試験の項目	保全方式又は頻度	検査名	
機器又は系統名 [蒸気タービン その他設備]	SA取水ろ過器	1.開放水後	高	2次系容器検査	(1)点検(運用又は体制) (2)点検(設備仕様)
		3B取水ろ過器	高	2次系容器検査	
		3C取水ろ過器	高	2次系容器検査	
		3A取水ろ過器	高	2次系容器検査	
		3B取水ろ過器	高	2次系容器検査	
		3C取水ろ過器	高	2次系容器検査	
		3D取水ろ過器	高	2次系容器検査	
		3E取水ろ過器	高	2次系容器検査	
		3F取水ろ過器	高	2次系容器検査	
		3取水ろ過器	高	2次系容器検査	
蒸気タービン [その他設備]	蒸気タービン(蒸気タービンに附属する給水ポンプ及び貯水設備並びに動水設備設備)等 [蒸気タービンシステム]	1.外観点検	高	1F	蒸気タービン開放検査 蒸気タービン開放検査 蒸気タービン開放検査 蒸気タービン開放検査 蒸気タービン開放検査 蒸気タービン開放検査 蒸気タービン開放検査 蒸気タービン開放検査 蒸気タービン開放検査 蒸気タービン開放検査
		1.外観点検	高	1F	
		1.外観点検	高	1F	
		1.外観点検	高	1F	
		1.外観点検	高	1F	
		1.外観点検	高	1F	
		1.外観点検	高	1F	
		1.外観点検	高	1F	
		1.外観点検	高	1F	
		1.外観点検	高	1F	
蒸気タービン [その他設備]	蒸気タービン(その他設備) その他の弁	1.開放水後	高	蒸気タービン開放検査	蒸気タービン開放検査 蒸気タービン開放検査 蒸気タービン開放検査 蒸気タービン開放検査 蒸気タービン開放検査 蒸気タービン開放検査 蒸気タービン開放検査 蒸気タービン開放検査 蒸気タービン開放検査 蒸気タービン開放検査
		1.開放水後	高	蒸気タービン開放検査	
		1.開放水後	高	蒸気タービン開放検査	
		1.開放水後	高	蒸気タービン開放検査	
		1.開放水後	高	蒸気タービン開放検査	
		1.開放水後	高	蒸気タービン開放検査	
		1.開放水後	高	蒸気タービン開放検査	
		1.開放水後	高	蒸気タービン開放検査	
		1.開放水後	高	蒸気タービン開放検査	
		1.開放水後	高	蒸気タービン開放検査	

機器又は系統名	実名称(機器名)	点検及び試験の項目	保全方式又は頻度	検査名
機器又は系統名 [蒸気タービン その他設備]	SA取水ろ過器	1.開放水後	高	2次系容器検査
		3B取水ろ過器	高	2次系容器検査
		3C取水ろ過器	高	2次系容器検査
		3A取水ろ過器	高	2次系容器検査
		3B取水ろ過器	高	2次系容器検査
		3C取水ろ過器	高	2次系容器検査
		3D取水ろ過器	高	2次系容器検査
		3E取水ろ過器	高	2次系容器検査
		3F取水ろ過器	高	2次系容器検査
		3取水ろ過器	高	2次系容器検査
蒸気タービン [その他設備]	蒸気タービン(蒸気タービンに附属する給水ポンプ及び貯水設備並びに動水設備設備)等 [蒸気タービンシステム]	1.外観点検	高	1F
		1.外観点検	高	1F
		1.外観点検	高	1F
		1.外観点検	高	1F
		1.外観点検	高	1F
		1.外観点検	高	1F
		1.外観点検	高	1F
		1.外観点検	高	1F
		1.外観点検	高	1F
		1.外観点検	高	1F
蒸気タービン [その他設備]	蒸気タービン(その他設備) その他の弁	1.開放水後	高	蒸気タービン開放検査
		1.開放水後	高	蒸気タービン開放検査
		1.開放水後	高	蒸気タービン開放検査
		1.開放水後	高	蒸気タービン開放検査
		1.開放水後	高	蒸気タービン開放検査
		1.開放水後	高	蒸気タービン開放検査
		1.開放水後	高	蒸気タービン開放検査
		1.開放水後	高	蒸気タービン開放検査
		1.開放水後	高	蒸気タービン開放検査
		1.開放水後	高	蒸気タービン開放検査

保全計画の相違  
 ・対象設備の保全内容、検査項目の設定に相違はあるが、対象とするSA設備が保全対象として設定され、点検計画を定めていることを示しており、大飯・泊とも点検対象として試験検査を行う計画であることを相違ない。  
 ・設定している保全内容及び検査項目について、それぞれの関連資料を示し、試験検査が可能であることを説明することも相違ない。  
 ・定期事業者検査を実施している場合には定期事業者検査要領書、検査実績なし又は検査対象外の場合には設計図書にて試験検査が可能であることを説明する。

赤字：設備、運用又は体制の相違（設計方針の相違）  
 青字：記載箇所又は記載内容の相違（記載方針の相違）  
 緑字：記載表現、設備名称の相違（実質的な相違なし）

第51条 原子炉格納容器下部の溶融炉心を冷却するための設備

大飯発電所3/4号炉	泊発電所3号炉	相違理由
<div data-bbox="174 194 1010 1366" style="border: 2px solid black; height: 734px; width: 373px;"></div> <div data-bbox="488 1369 936 1401" style="border: 1px solid black; padding: 2px; margin-top: 10px;">                     枠囲みの範囲は機密に係る事項ですので公開することはできません。                 </div>	<div data-bbox="1144 290 1872 1321" style="border: 2px solid black; height: 646px; width: 325px;"></div> <div data-bbox="1424 1327 1872 1353" style="border: 1px solid black; padding: 2px; margin-top: 10px;">                     枠囲みの内容は機密情報に属しますので公開できません。                 </div>	

泊発電所3号炉 SA基準適合性 比較表

赤字：設備、運用又は体制の相違（設計方針の相違）  
 青字：記載箇所又は記載内容の相違（記載方針の相違）  
 緑字：記載表現、設備名称の相違（実質的な相違なし）

第51条 原子炉格納容器下部の溶融炉心を冷却するための設備

大飯発電所3/4号炉	泊発電所3号炉	相違理由
	<div data-bbox="1144 292 1872 1318" style="border: 2px solid black; width: 100%; height: 100%;"></div> <div data-bbox="1420 1326 1868 1350" style="text-align: right; font-size: small;"> <span style="border: 1px solid black; display: inline-block; width: 1em; height: 1em; vertical-align: middle;"></span> 枠囲みの内容は機密情報に属しますので公開できません。                 </div>	<p>資料構成の相違</p> <ul style="list-style-type: none"> <li>・試験検査に係る資料の充実化</li> <li>・試験検査の適合性としてアクセスドアを設ける設計としている関連資料として建屋配置図を示している。</li> </ul>



赤字：設備、運用又は体制の相違（設計方針の相違）  
 青字：記載箇所又は記載内容の相違（記載方針の相違）  
 緑字：記載表現、設備名称の相違（実質的な相違なし）

第51条 原子炉格納容器下部の溶融炉心を冷却するための設備

大飯発電所3/4号炉	泊発電所3号炉	相違理由
<div data-bbox="176 193 1010 1366" style="border: 2px solid black; height: 735px; width: 372px;"></div> <div data-bbox="483 1369 936 1398" style="border: 1px solid black; padding: 2px; width: fit-content; margin: 0 auto;">枠囲みの範囲は機密に係る事項ですので公開することはできません。</div>	<div data-bbox="1149 284 1870 1310" style="border: 2px solid black; height: 643px; width: 322px;"></div> <div data-bbox="1261 1326 1704 1345" style="border: 1px solid black; padding: 2px; width: fit-content; margin: 0 auto;">枠囲みの内容は機密情報に属しますので公開できません。</div>	

泊発電所3号炉 SA基準適合性 比較表

赤字：設備、運用又は体制の相違（設計方針の相違）  
 青字：記載箇所又は記載内容の相違（記載方針の相違）  
 緑字：記載表現、設備名称の相違（実質的な相違なし）

第51条 原子炉格納容器下部の溶融炉心を冷却するための設備

大飯発電所3/4号炉	泊発電所3号炉	相違理由
	<div data-bbox="1144 288 1870 1316" style="border: 2px solid black; width: 100%; height: 100%;"></div> <div data-bbox="1420 1321 1865 1343" style="text-align: right; margin-top: 10px;"> <span style="border: 1px solid black; display: inline-block; width: 15px; height: 10px;"></span> 枠囲みの内容は機密情報に属しますので公開できません。                 </div>	<p>資料構成の相違</p> <ul style="list-style-type: none"> <li>・試験検査に係る資料の充実化</li> <li>・試験検査の適合性としてアクセスドアを設ける設計である記述の確認資料として建屋配置図に図示している。</li> </ul>



赤字：設備、運用又は体制の相違（設計方針の相違）  
 青字：記載箇所又は記載内容の相違（記載方針の相違）  
 緑字：記載表現、設備名称の相違（実質的な相違なし）

第51条 原子炉格納容器下部の溶融炉心を冷却するための設備

大飯発電所3/4号炉	泊発電所3号炉	相違理由
<div data-bbox="176 193 1005 1366" style="border: 2px solid black; height: 735px; width: 370px;"></div> <div data-bbox="483 1369 931 1398" style="border: 1px solid black; padding: 2px; width: fit-content; margin: 0 auto;">枠囲みの範囲は機密に係る事項ですので公開することはできません。</div>	<div data-bbox="1146 284 1872 1313" style="border: 2px solid black; height: 645px; width: 324px;"></div> <div data-bbox="1258 1326 1704 1347" style="border: 1px solid black; padding: 2px; width: fit-content; margin: 0 auto;">枠囲みの内容は機密情報に属しますので公開できません。</div>	

赤字：設備、運用又は体制の相違（設計方針の相違）  
 青字：記載箇所又は記載内容の相違（記載方針の相違）  
 緑字：記載表現、設備名称の相違（実質的な相違なし）

第51条 原子炉格納容器下部の溶融炉心を冷却するための設備

大飯発電所3/4号炉	泊発電所3号炉	相違理由
<div data-bbox="174 193 1005 1362" style="border: 2px solid black; height: 733px; width: 371px;"></div> <div data-bbox="481 1369 931 1398" style="border: 1px solid black; padding: 2px; width: fit-content; margin-left: auto; margin-right: auto;">                     枠囲みの範囲は機密に係る事項ですので公開することはできません。                 </div>	<div data-bbox="1075 181 1917 1378" style="border: 2px solid black; height: 750px; width: 376px;"></div> <div data-bbox="1391 1390 1912 1414" style="border: 1px solid black; padding: 2px; width: fit-content; margin-left: auto; margin-right: auto;">                     枠囲みの内容は機密情報に属しますので公開できません。                 </div>	



赤字：設備、運用又は体制の相違（設計方針の相違）  
 青字：記載箇所又は記載内容の相違（記載方針の相違）  
 緑字：記載表現、設備名称の相違（実質的な相違なし）

第51条 原子炉格納容器下部の溶融炉心を冷却するための設備

大飯発電所3/4号炉	泊発電所3号炉	相違理由
<p style="text-align: center;"><u>改 1</u></p> <p style="text-align: center;">関西電力株式会社 大飯発電所                      第3号機 第16保全サイクル                      定期事業者検査要領書</p> <p>施設名：原子炉格納施設                      検査名：原子炉格納容器安全系機能検査                      要領書番号：O3-16-158</p>	<p style="text-align: center;">北海道電力株式会社 泊発電所                      3号機 第2保全サイクル                      定期事業者検査要領書</p> <p>設備名：原子炉格納施設                      検査名：原子炉格納容器スプレイ系機能検査                      要領書番号：HT3-48</p> <p style="text-align: right;">試-原-105</p>	

赤字：設備、運用又は体制の相違（設計方針の相違）  
 青字：記載箇所又は記載内容の相違（記載方針の相違）  
 緑字：記載表現、設備名称の相違（実質的な相違なし）

第51条 原子炉格納容器下部の溶融炉心を冷却するための設備

大飯発電所3 / 4号炉	泊発電所3号炉	相違理由
<div data-bbox="179 191 1008 1364" style="border: 2px solid black; height: 735px; width: 370px; margin: 10px auto;"></div> <div data-bbox="488 1369 936 1401" style="border: 1px solid black; padding: 2px; width: fit-content; margin: 10px auto;">枠囲みの範囲は機密に係る事項ですので公開することはできません。</div>	<div data-bbox="1142 279 1870 1316" style="border: 2px solid black; height: 650px; width: 325px; margin: 10px auto;"></div> <div data-bbox="1258 1327 1706 1359" style="border: 1px solid black; padding: 2px; width: fit-content; margin: 10px auto;">枠囲みの内容は機密情報に属しますので公開できません。</div>	

赤字：設備、運用又は体制の相違（設計方針の相違）  
 青字：記載箇所又は記載内容の相違（記載方針の相違）  
 緑字：記載表現、設備名称の相違（実質的な相違なし）

第51条 原子炉格納容器下部の溶融炉心を冷却するための設備

大飯発電所3 / 4号炉	泊発電所3号炉	相違理由
<p style="text-align: center;">改 0</p> <p style="text-align: center;">関西電力株式会社 大飯発電所                      第3号機 第15保全サイクル                      定期事業者検査要領書</p> <p>設 備 名：原子炉冷却系統設備、原子炉格納施設                      検 査 名：運転中の主要機器機能検査                      要領書番号：O3-15-114</p>	<p style="text-align: center;">北海道電力株式会社 泊発電所                      3号機 第1保全サイクル                      定期事業者検査要領書</p> <p>設 備 名：原子炉冷却系統設備                      原子炉格納施設                      検 査 名：運転中の主要機器機能検査（状態監視含む）                      要領書番号：HT3-運-1</p>	

赤字：設備、運用又は体制の相違（設計方針の相違）  
 青字：記載箇所又は記載内容の相違（記載方針の相違）  
 緑字：記載表現、設備名称の相違（実質的な相違なし）

第51条 原子炉格納容器下部の溶融炉心を冷却するための設備

大飯発電所3 / 4号炉	泊発電所3号炉	相違理由
<div data-bbox="176 193 1010 1366" style="border: 2px solid black; height: 735px; width: 372px;"></div> <div data-bbox="483 1369 934 1398" style="border: 1px solid black; padding: 2px; width: fit-content; margin: 0 auto;">枠囲みの範囲は機密に係る事項ですので公開することはできません。</div>	<div data-bbox="1140 288 1879 1339" style="border: 2px solid black; height: 658px; width: 330px;"></div> <div data-bbox="1420 1339 1872 1359" style="border: 1px solid black; padding: 2px; width: fit-content; margin: 0 auto;">枠囲みの内容は機密情報に属しますので公開できません。</div>	<p>資料構成の相違</p> <ul style="list-style-type: none"> <li>・泊の定期事業者検査要領書では、試験対象設備について設備概要を作成していないが、設備概要は、当該定期事業者検査要領書において対象SA設備が含まれることを示す書類である。</li> <li>・泊では、対象SA設備に関する記載のある定期事業者検査要領書の構成書類を示しており、いずれの関連書類においても、対象SA設備が定期事業者検査対象として検査実績があることを示しており、試験検査対象を示していることに相違はない。</li> </ul>

赤字：設備、運用又は体制の相違（設計方針の相違）  
 青字：記載箇所又は記載内容の相違（記載方針の相違）  
 緑字：記載表現、設備名称の相違（実質的な相違なし）

第51条 原子炉格納容器下部の溶融炉心を冷却するための設備

大飯発電所3/4号炉	泊発電所3号炉	相違理由
<p style="text-align: center;">改 0</p> <p style="text-align: center;">関西電力株式会社 大飯発電所</p> <p style="text-align: center;">第3号機 第12回</p> <p style="text-align: center;">定期事業者検査要領書</p> <p>設備名：原子炉格納施設                      検査名：原子炉格納容器スプレイ系ポンプ分解検査                      要領書番号：O3-12-49</p>		<p>保全計画の相違</p> <p>・保全計画の相違(実績有無の相違を含む)により、泊では定期事業者検査要領書の作成実績がないため、設計図書にて試験検査が可能な設計であることを示す。</p>



赤字：設備、運用又は体制の相違（設計方針の相違）  
 青字：記載箇所又は記載内容の相違（記載方針の相違）  
 緑字：記載表現、設備名称の相違（実質的な相違なし）

第51条 原子炉格納容器下部の溶融炉心を冷却するための設備

大飯発電所3/4号炉	泊発電所3号炉	相違理由
<div data-bbox="174 193 1010 1369" style="border: 2px solid black; height: 737px; width: 373px;"></div> <div data-bbox="488 1369 936 1401" style="border: 1px solid black; padding: 2px; width: fit-content; margin: 0 auto;">枠囲みの範囲は機密に係る事項ですので公開することはできません。</div>	<div data-bbox="1146 284 1870 1310" style="border: 2px solid black; height: 643px; width: 323px;"></div> <div data-bbox="1258 1334 1706 1358" style="border: 1px solid black; padding: 2px; width: fit-content; margin: 0 auto;">枠囲みの内容は機密情報に属しますので公開できません。</div>	<p>保安計画の相違</p> <ul style="list-style-type: none"> <li>保安計画の相違(実績有無の相違を含む)により、泊では定期事業者検査要領書の作成実績がないため、設計図書にて試験検査が可能な設計であることを示す。</li> </ul>

第51条 原子炉格納容器下部の溶融炉心を冷却するための設備

赤字：設備、運用又は体制の相違（設計方針の相違）  
 青字：記載箇所又は記載内容の相違（記載方針の相違）  
 緑字：記載表現、設備名称の相違（実質的な相違なし）

大飯発電所3/4号炉

機器又は系統名	型式(機器名)	点検及び試験の項目	保全の重要度	保全方式又は頻度	検査名	備考 (0)点検に用いる試験設備技術
A格納容器スプレイト機器		1.開閉点検	高	130M	次系高圧交換器検査	青
		2.共振試験	高	130M	次系高圧交換器検査	
		3.漏えい試験	高	130M	次系高圧交換器検査	
B格納容器スプレイト機器		1.開閉点検	高	130M	次系高圧交換器検査	青
		2.共振試験	高	130M	次系高圧交換器検査	
		3.漏えい試験	高	130M	次系高圧交換器検査	
原子炉格納容器スプレイト系主要弁	3V-CP-024A	1.分解点検	高	78M	原子炉格納容器安全系主要弁分解検査	青 青 青 青 青 青 青 青 青 青
		1.分解点検	高	78M	原子炉格納容器安全系主要弁分解検査	
		1.分解点検	高	130M	原子炉格納容器安全系主要弁分解検査	
		1.分解点検	高	130M	原子炉格納容器安全系主要弁分解検査	
		1.分解点検	高	130M	原子炉格納容器安全系主要弁分解検査	
		1.分解点検	高	182M	原子炉格納容器安全系主要弁分解検査	
		1.分解点検	高	13M~182M	原子炉格納容器安全系主要弁分解検査	
		1.開閉点検	高	130M	1次系高圧交換器検査	
		1.開閉点検	高・低	B	1次系弁検査	
		1.開閉点検	高・低	104M~130M	1次系弁検査	
よう素除去薬高タンク	2台	1.開閉点検	高	130M	1次系高圧交換器検査	青
		1.開閉点検	高	130M	1次系高圧交換器検査	
		1.開閉点検	高	130M	1次系高圧交換器検査	
原子炉格納容器頭(圧力経路設備その他の安全設備)その他の弁	1式	1.開閉点検	高	B	1次系弁検査	青
		1.開閉点検	高	B	1次系弁検査	
		1.開閉点検	高	B	1次系弁検査	
原子炉格納容器頭(圧力経路設備その他の安全設備)その他の弁	1式	1.開閉点検	高	B	1次系弁検査	青
		1.開閉点検	高	B	1次系弁検査	
		1.開閉点検	高	B	1次系弁検査	
原子炉格納容器頭(圧力経路設備その他の安全設備)その他の弁	1式	1.開閉点検	高	B	1次系弁検査	青
		1.開閉点検	高	B	1次系弁検査	
		1.開閉点検	高	B	1次系弁検査	
その他AM格納容器内注水機器	1式	1.開閉点検	高	130M	1次系高圧交換器検査	青
		1.開閉点検	高	130M	1次系高圧交換器検査	
		1.開閉点検	高	130M	1次系高圧交換器検査	

泊発電所3号炉

機器又は系統名	型式(機器名)	点検及び試験の項目	保全の重要度	保全方式又は頻度	検査名	備考 (0)点検に用いる試験設備技術
原子炉格納容器スプレイト系主要弁	3V-CP-024A	1.分解点検	高	78M	原子炉格納容器安全系主要弁分解検査	青 青 青 青 青 青 青 青 青 青
		1.分解点検	高	78M	原子炉格納容器安全系主要弁分解検査	
		1.分解点検	高	130M	原子炉格納容器安全系主要弁分解検査	
		1.分解点検	高	130M	原子炉格納容器安全系主要弁分解検査	
		1.分解点検	高	130M	原子炉格納容器安全系主要弁分解検査	
		1.分解点検	高	182M	原子炉格納容器安全系主要弁分解検査	
		1.分解点検	高	13M~182M	原子炉格納容器安全系主要弁分解検査	
		1.開閉点検	高	130M	1次系高圧交換器検査	
		1.開閉点検	高・低	B	1次系弁検査	
		1.開閉点検	高・低	104M~130M	1次系弁検査	
よう素除去薬高タンク	2台	1.開閉点検	高	130M	1次系高圧交換器検査	青
		1.開閉点検	高	130M	1次系高圧交換器検査	
		1.開閉点検	高	130M	1次系高圧交換器検査	
原子炉格納容器頭(圧力経路設備その他の安全設備)その他の弁	1式	1.開閉点検	高	B	1次系弁検査	青
		1.開閉点検	高	B	1次系弁検査	
		1.開閉点検	高	B	1次系弁検査	
原子炉格納容器頭(圧力経路設備その他の安全設備)その他の弁	1式	1.開閉点検	高	B	1次系弁検査	青
		1.開閉点検	高	B	1次系弁検査	
		1.開閉点検	高	B	1次系弁検査	
その他AM格納容器内注水機器	1式	1.開閉点検	高	130M	1次系高圧交換器検査	青
		1.開閉点検	高	130M	1次系高圧交換器検査	
		1.開閉点検	高	130M	1次系高圧交換器検査	

保全計画の相違  
 ・対象設備の保全内容、検査項目の設定に相違はあるが、対象とするSA設備が保全対象として設定され、点検計画を定めていることを示しており、大飯・泊とも点検対象として試験検査を行う計画であることに相違はない。  
 ・設定している保全内容及び検査項目について、それぞれの関連資料を示し、試験検査が可能であることを説明することも相違はない。  
 ・定期事業者検査を実施している場合には定期事業者検査要領書、検査実績なし又は検査対象外の場合には設計図書にて試験検査が可能であることを説明する。

赤字：設備、運用又は体制の相違（設計方針の相違）  
 青字：記載箇所又は記載内容の相違（記載方針の相違）  
 緑字：記載表現、設備名称の相違（実質的な相違なし）

第51条 原子炉格納容器下部の溶融炉心を冷却するための設備

大飯発電所3/4号炉	泊発電所3号炉	相違理由
<p style="text-align: center;">改 2</p> <p style="text-align: center;">関西電力株式会社 大飯発電所                      第3号機 第10回                      定期事業者検査要領書</p> <p>設 備 名：原子炉冷却系統設備                      燃料設備                      原子炉格納施設                      検 査 名：1次系熱交換器検査                      要領書番号：O3-10-91</p>		<p>保全計画の相違                      ・保全計画の相違(実績有無の相違を含む)により、泊では定期事業者検査要領書の作成実績がないため、設計図書にて試験検査が可能な設計であることを示す。</p>

赤字：設備、運用又は体制の相違（設計方針の相違）  
 青字：記載箇所又は記載内容の相違（記載方針の相違）  
 緑字：記載表現、設備名称の相違（実質的な相違なし）

第51条 原子炉格納容器下部の溶融炉心を冷却するための設備

大飯発電所3/4号炉	泊発電所3号炉	相違理由
<div data-bbox="176 193 1010 1366" style="border: 2px solid black; height: 735px; width: 372px;"></div> <div data-bbox="483 1369 936 1401" style="border: 1px solid black; padding: 2px; width: fit-content; margin: 0 auto;">枠囲みの範囲は機密に係る事項ですので公開することはできません。</div>	<div data-bbox="1144 284 1872 1310" style="border: 2px solid black; height: 643px; width: 325px;"></div> <div data-bbox="1261 1331 1704 1353" style="border: 1px solid black; padding: 2px; width: fit-content; margin: 0 auto;">枠囲みの内容は機密情報に属しますので公開できません。</div>	<p>保全計画の相違</p> <ul style="list-style-type: none"> <li>・保全計画の相違(実績有無の相違を含む)により、泊では定期事業者検査要領書の作成実績がないため、設計図書にて試験検査が可能な設計であることを示す。</li> </ul>

泊発電所3号炉 SA基準適合性 比較表

赤字：設備、運用又は体制の相違（設計方針の相違）  
 青字：記載箇所又は記載内容の相違（記載方針の相違）  
 緑字：記載表現、設備名称の相違（実質的な相違なし）

第51条 原子炉格納容器下部の溶融炉心を冷却するための設備

大飯発電所3/4号炉	泊発電所3号炉	相違理由
<p style="text-align: center;">51-5 系統図</p>	<p style="text-align: center;">51-4 系統図</p>	

赤字：設備、運用又は体制の相違（設計方針の相違）  
 青字：記載箇所又は記載内容の相違（記載方針の相違）  
 緑字：記載表現、設備名称の相違（実質的な相違なし）

第51条 原子炉格納容器下部の溶融炉心を冷却するための設備

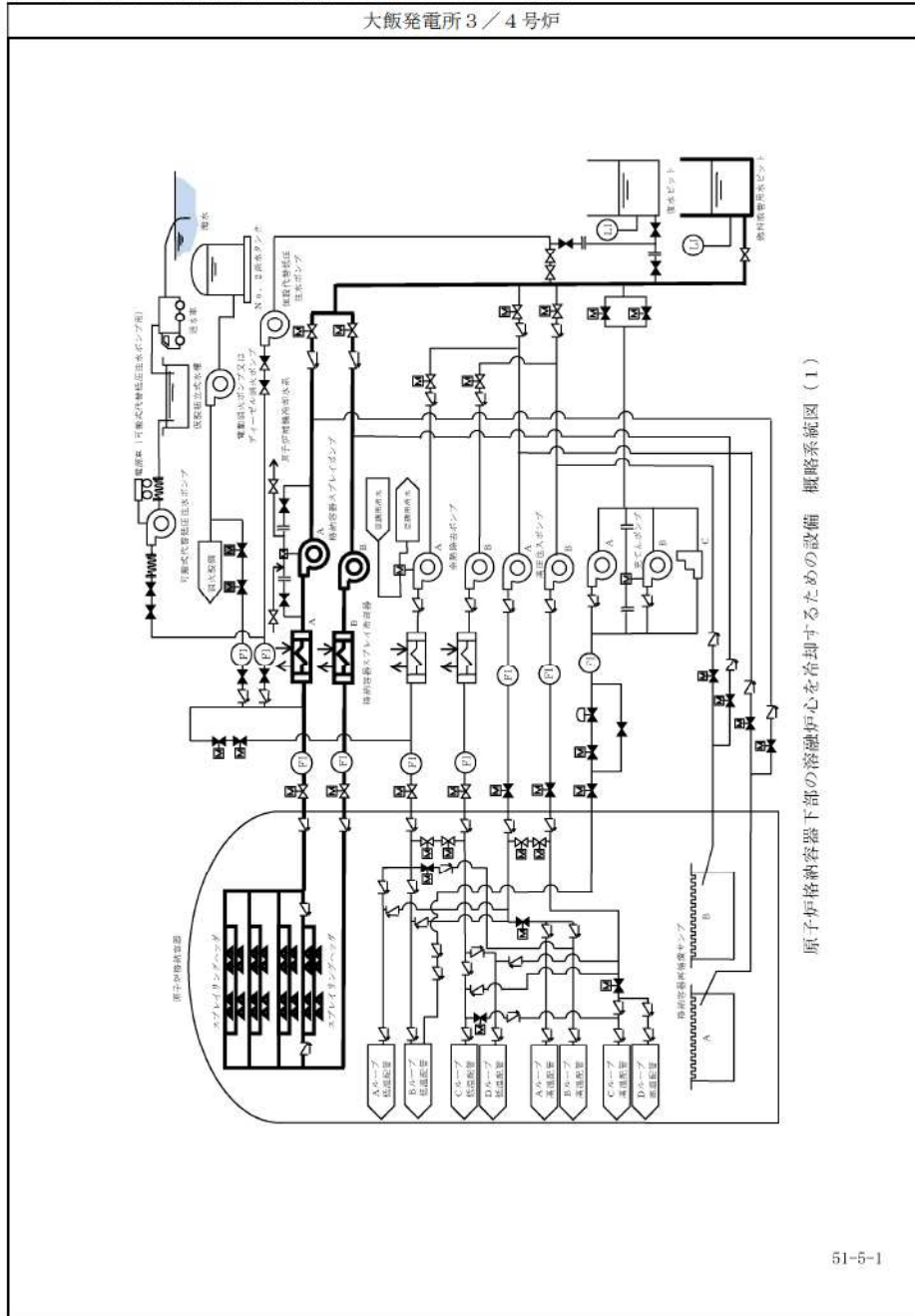

51-5-1

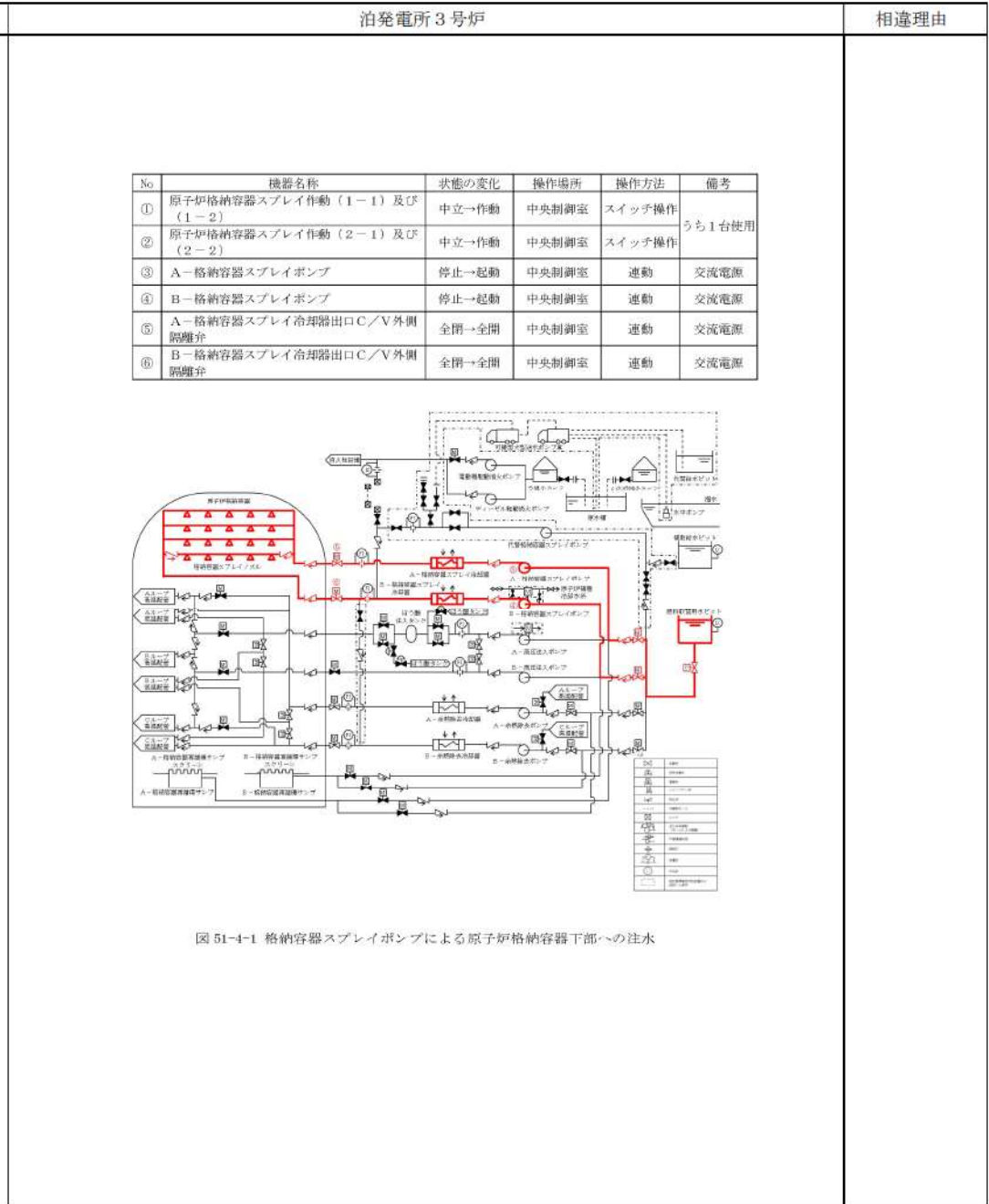

相違理由

赤字：設備、運用又は体制の相違（設計方針の相違）  
 青字：記載箇所又は記載内容の相違（記載方針の相違）  
 緑字：記載表現、設備名称の相違（実質的な相違なし）

第51条 原子炉格納容器下部の溶融炉心を冷却するための設備

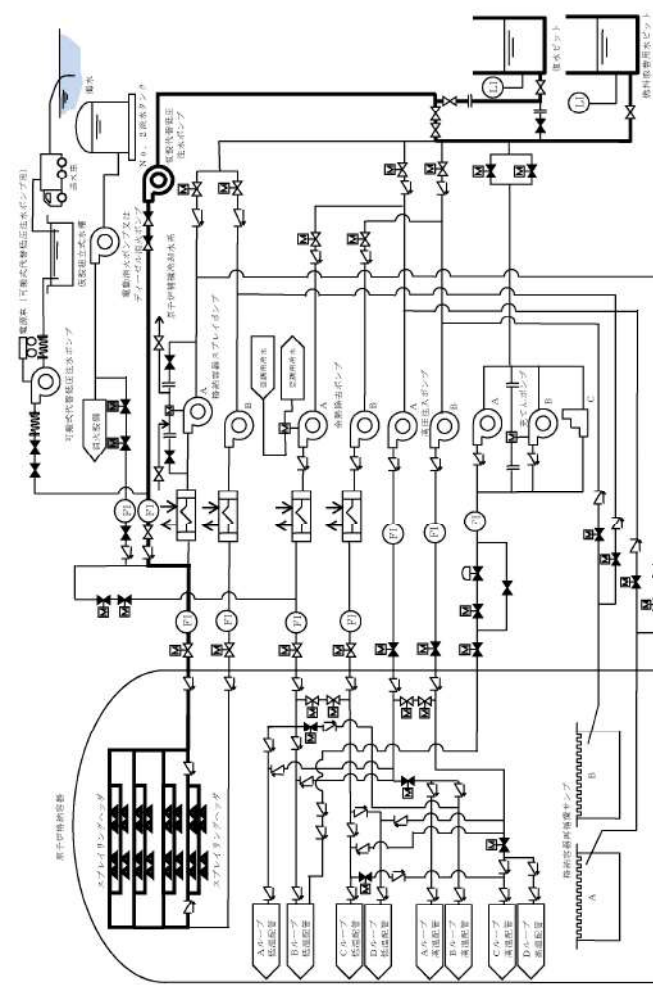
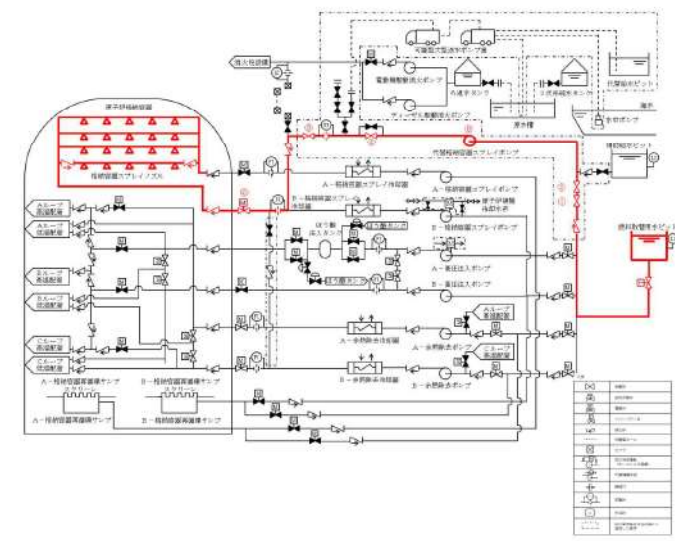
大飯発電所3/4号炉	泊発電所3号炉	相違理由																																										
 <p>原子炉格納容器下部の溶融炉心を冷却するための設備 概略系統図(2)</p>	 <p>図 51-4-2 代替格納容器スプレイポンプによる原子炉格納容器下部への注水</p> <table border="1" data-bbox="1164 351 1859 606"> <thead> <tr> <th>No.</th> <th>機器名称</th> <th>状態の変化</th> <th>操作場所</th> <th>操作方法</th> <th>備考</th> </tr> </thead> <tbody> <tr> <td>①</td> <td>代替格納容器スプレイポンプ入口第1止め弁</td> <td>全閉→全開</td> <td>周辺補機棟 T.P. 24.3a</td> <td>手動操作</td> <td>-</td> </tr> <tr> <td>②</td> <td>代替格納容器スプレイポンプ入口第2止め弁</td> <td>全閉→全開</td> <td>周辺補機棟 T.P. 24.3a</td> <td>手動操作</td> <td>-</td> </tr> <tr> <td>③</td> <td>代替格納容器スプレイポンプ接続ライン止め弁</td> <td>全閉→全開</td> <td>原子炉補助建屋 T.P. 10.3a</td> <td>手動操作</td> <td>-</td> </tr> <tr> <td>④</td> <td>代替格納容器スプレイポンプ出口格納容器スプレイ用絞り弁</td> <td>全開→調整開</td> <td>周辺補機棟 T.P. 10.3a</td> <td>手動操作</td> <td>-</td> </tr> <tr> <td>⑤</td> <td>B-格納容器スプレイ冷却器出口C/V外側隔離弁</td> <td>全閉→全開</td> <td>中央制御室</td> <td>操作器操作</td> <td>交流電源</td> </tr> <tr> <td>⑥</td> <td>代替格納容器スプレイポンプ</td> <td>停止→起動</td> <td>周辺補機棟 T.P. 10.3a</td> <td>スイッチ操作</td> <td>交流電源</td> </tr> </tbody> </table>	No.	機器名称	状態の変化	操作場所	操作方法	備考	①	代替格納容器スプレイポンプ入口第1止め弁	全閉→全開	周辺補機棟 T.P. 24.3a	手動操作	-	②	代替格納容器スプレイポンプ入口第2止め弁	全閉→全開	周辺補機棟 T.P. 24.3a	手動操作	-	③	代替格納容器スプレイポンプ接続ライン止め弁	全閉→全開	原子炉補助建屋 T.P. 10.3a	手動操作	-	④	代替格納容器スプレイポンプ出口格納容器スプレイ用絞り弁	全開→調整開	周辺補機棟 T.P. 10.3a	手動操作	-	⑤	B-格納容器スプレイ冷却器出口C/V外側隔離弁	全閉→全開	中央制御室	操作器操作	交流電源	⑥	代替格納容器スプレイポンプ	停止→起動	周辺補機棟 T.P. 10.3a	スイッチ操作	交流電源	
No.	機器名称	状態の変化	操作場所	操作方法	備考																																							
①	代替格納容器スプレイポンプ入口第1止め弁	全閉→全開	周辺補機棟 T.P. 24.3a	手動操作	-																																							
②	代替格納容器スプレイポンプ入口第2止め弁	全閉→全開	周辺補機棟 T.P. 24.3a	手動操作	-																																							
③	代替格納容器スプレイポンプ接続ライン止め弁	全閉→全開	原子炉補助建屋 T.P. 10.3a	手動操作	-																																							
④	代替格納容器スプレイポンプ出口格納容器スプレイ用絞り弁	全開→調整開	周辺補機棟 T.P. 10.3a	手動操作	-																																							
⑤	B-格納容器スプレイ冷却器出口C/V外側隔離弁	全閉→全開	中央制御室	操作器操作	交流電源																																							
⑥	代替格納容器スプレイポンプ	停止→起動	周辺補機棟 T.P. 10.3a	スイッチ操作	交流電源																																							

泊発電所3号炉 SA基準適合性 比較表

赤字：設備、運用又は体制の相違（設計方針の相違）  
 青字：記載箇所又は記載内容の相違（記載方針の相違）  
 緑字：記載表現、設備名称の相違（実質的な相違なし）

第51条 原子炉格納容器下部の溶融炉心を冷却するための設備

大飯発電所3/4号炉	泊発電所3号炉	相違理由
<p>51-6 容量設定根拠 3号炉</p>	<p>51-5 容量設定根拠</p>	

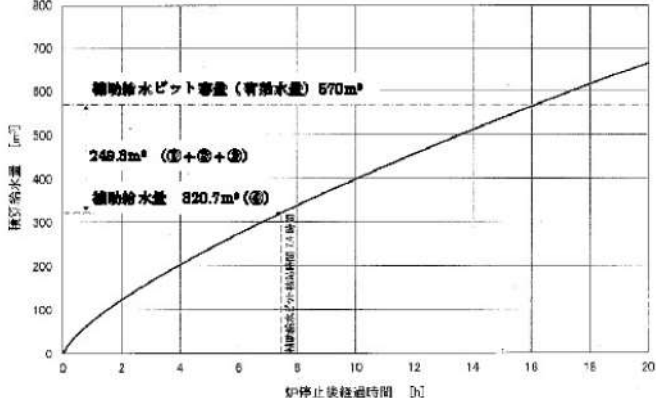

赤字：設備、運用又は体制の相違（設計方針の相違）  
 青字：記載箇所又は記載内容の相違（記載方針の相違）  
 緑字：記載表現、設備名称の相違（実質的な相違なし）

大飯発電所3/4号炉	泊発電所3号炉	相違理由
	<p>2. 水源に関する評価（蒸気発生器注水）</p> <p>重要事故シーケンス                  【全交流動力電源喪失＋原子炉補機冷却機能喪失＋RCP シール LOCA】及び                  【全交流動力電源喪失＋原子炉補機冷却機能喪失＋RCP シール LOCAが発生しない場合】</p> <p>○水源                  補助給水ピット：570m<sup>3</sup>（有効水量）</p> <p>○水使用パターン                  補助給水ピット枯渇時間の評価に用いる蒸気発生器への必要注水量を以下に示す。                  【必要注水量内訳】注水温度 40℃</p> <ul style="list-style-type: none"> <li>① 出力運転状態から高温停止状態までの顕熱除去 : - 11.6m<sup>3</sup>                      （原子炉トリップ遅れ、燃料及び1次冷却材蓄積熱量他）</li> <li>② 高温停止状態から冷却維持温度（170℃）までの顕熱除去 : 158.5m<sup>3</sup>                      （1次冷却材及び蒸気発生器保有水量等の顕熱）</li> <li>③ 蒸気発生器水位回復 : 104.4m<sup>3</sup></li> </ul> <p style="text-align: right;">上記①～③の合計 : 249.3m<sup>3</sup></p> <ul style="list-style-type: none"> <li>④ 崩壊熱除去 : 320.7m<sup>3</sup></li> </ul>  <p>補助給水ピットの有効水量 570m<sup>3</sup> から、1次冷却材系統を出力運転状態から 170℃まで減温するために必要な給水量等（249.3m<sup>3</sup>）を引いた量（320.7m<sup>3</sup>）の水がなくなる時間を崩壊熱除去に応じた注水量カーブから求め、7.4時間後となる。</p> <p>7.4時間までに、可搬型大型送水ポンプ車による補助給水ピットへの補給を行うことにより対応可能である。</p> <p>補助給水ピットへの補給は、海から取水する。</p>	

泊発電所3号炉 SA基準適合性 比較表

赤字：設備、運用又は体制の相違（設計方針の相違）  
 青字：記載箇所又は記載内容の相違（記載方針の相違）  
 緑字：記載表現、設備名称の相違（実質的な相違なし）

第51条 原子炉格納容器下部の溶融炉心を冷却するための設備

大飯発電所3/4号炉	泊発電所3号炉	相違理由
	<p>○水源評価結果</p> <p>事故後、7.4時間までに、可搬型大型送水ポンプ車による補助給水ピットへの補給を行うことにより、対応可能である。</p> <p>7.4時間までに、可搬型大型送水ポンプ車により補給が可能なのは成立性評価（所要時間）にて確認した。</p>	

赤字：設備、運用又は体制の相違（設計方針の相違）  
 青字：記載箇所又は記載内容の相違（記載方針の相違）  
 緑字：記載表現、設備名称の相違（実質的な相違なし）

第51条 原子炉格納容器下部の溶融炉心を冷却するための設備

大飯発電所3 / 4号炉	泊発電所3号炉	相違理由												
	<p style="text-align: center;">容-2(1/8)</p> <table border="1" data-bbox="1182 312 1883 448"> <thead> <tr> <th>名 称</th> <th colspan="2">燃料取替用水ビット</th> </tr> </thead> <tbody> <tr> <td>容 量</td> <td>m<sup>3</sup>/個</td> <td>1以上(2,000)</td> </tr> <tr> <td>最高使用圧力</td> <td>MPa</td> <td>大気圧</td> </tr> <tr> <td>最高使用温度</td> <td>℃</td> <td>95</td> </tr> </tbody> </table> <p>[ ]内は公称値を示す。</p> <p>計測制御系統施設のうちほう酸注入機能を有する設備、原子炉格納施設のうち圧力低減設備その他の安全設備（格納容器安全設備）及びその他発電用原子炉の附属施設（火災防護設備）のうち消火設備と兼用。</p> <p>最高使用圧力及び温度は、原子炉格納施設のうち圧力低減設備その他の安全設備（格納容器安全設備）に使用する場合は記載事項であり、重大事故等対処設備としての値。</p> <p><b>【設定根拠】</b></p> <p>・設計基準対象施設</p> <p>設計基準対象施設の燃料取替用水ビットの概要、容量、個数の設定根拠については、平成15年11月21日付け平成15・07・22原第25号にて認可された工事計画の参考資料1-1「設備別記載事項の設定根拠に関する説明書（原子炉冷却系統設備）」による。</p> <p>その他発電用原子炉の附属施設（火災防護設備）のうち消火設備として使用する燃料取替用水ビットは、原子炉格納容器内で火災が発生した際、消火要員による消火活動が困難である場合に、原子炉格納容器内にスプレイすることにより、原子炉格納容器全体の雰囲気水を水演で覆い消火を行うために設置する。</p> <p>・重大事故等対処設備</p> <p>重大事故等時に原子炉冷却系統施設のうち非常用炉心冷却設備その他原子炉注水設備として使用する燃料取替用水ビットは、以下の機能を有する。</p> <p>燃料取替用水ビットは、原子炉冷却材圧力バウンダリが高圧の状態であって、設計基準事故対処設備が有する原子炉の冷却機能が喪失した場合においても炉心の著しい損傷を防止するため、原子炉を冷却するために設置する。</p> <p style="text-align: center;">[ ] 枠囲みの内容は機密情報に属しますので公開できません。</p>	名 称	燃料取替用水ビット		容 量	m <sup>3</sup> /個	1以上(2,000)	最高使用圧力	MPa	大気圧	最高使用温度	℃	95	
名 称	燃料取替用水ビット													
容 量	m <sup>3</sup> /個	1以上(2,000)												
最高使用圧力	MPa	大気圧												
最高使用温度	℃	95												

赤字：設備、運用又は体制の相違（設計方針の相違）  
 青字：記載箇所又は記載内容の相違（記載方針の相違）  
 緑字：記載表現、設備名称の相違（実質的な相違なし）

第51条 原子炉格納容器下部の溶融炉心を冷却するための設備

大飯発電所3 / 4号炉	泊発電所3号炉	相違理由
	<p style="text-align: center;">容-2(2/8)</p> <div style="border: 1px solid black; padding: 5px;"> <p>系統構成は、電動補助給水ポンプ及びタービン動補助給水ポンプ、補助給水ピット又は主蒸気速がし弁の故障等により2次冷却系からの除熱機能が喪失した場合の1次系のフィードアンドブリードとして、燃料取替用水ピットを水源とした高圧注入ポンプは、安全注入系統により炉心へほう酸水を注水し、加圧器速がし弁を開操作することでフィードアンドブリードできる設計とする。</p> <p>これらの系統構成については、設備別記載事項の設定根拠に関する説明書別添3「技術基準規則第60条系統図」による。</p> <p>燃料取替用水ピットは、原子炉冷却材圧力バウンダリが高圧の状態であって、設計基準事故対処設備が有する原子炉の減圧機能が喪失した場合においても炉心の著しい損傷及び原子炉格納容器の破損を防止するため、原子炉冷却材圧力バウンダリを減圧するために設置する。</p> <p>系統構成は、電動補助給水ポンプ及びタービン動補助給水ポンプ、補助給水ピット又は主蒸気速がし弁の故障等により蒸気発生器2次側による炉心冷却を用いた1次冷却系統の減圧機能が喪失した場合の1次系のフィードアンドブリードとして、燃料取替用水ピットを水源とした高圧注入ポンプは、安全注入系統により炉心へほう酸水を注水し、格納容器再循環サンプ水位が再循環切替可能水位に到達後、格納容器再循環サンプを水源とした高圧注入ポンプは、再循環により炉心へほう酸水の注水を継続することで1次冷却系統をフィードアンドブリードできる設計とする。</p> <p>これらの系統構成については、設備別記載事項の設定根拠に関する説明書別添3「技術基準規則第61条系統図」による。</p> <p>燃料取替用水ピットは、原子炉冷却材圧力バウンダリが低圧の状態であって、設計基準事故対処設備が有する原子炉の冷却機能が喪失した場合においても炉心の著しい損傷及び原子炉格納容器の破損を防止するため、原子炉を冷却するために設置する。</p> </div>	

赤字：設備、運用又は体制の相違（設計方針の相違）  
 青字：記載箇所又は記載内容の相違（記載方針の相違）  
 緑字：記載表現、設備名称の相違（実質的な相違なし）

第51条 原子炉格納容器下部の溶融炉心を冷却するための設備

大飯発電所3 / 4号炉	泊発電所3号炉	相違理由
	<p style="text-align: center;">容-2(3/8)</p> <div style="border: 1px solid black; padding: 5px;"> <p>運転中の1次冷却材喪失事象時において余熱除去ポンプ及び高圧注入ポンプの故障等により炉心注水機能が喪失した場合、運転中の1次冷却材喪失事象時において余熱除去ポンプ若しくは高圧注入ポンプによる再循環又はB-格納容器スプレイポンプによる代替再循環で格納容器再循環サンブスクリーン閉塞の兆候が見られた場合並びに原子炉の冷却機能が喪失し、炉心の著しい損傷が発生した場合であって交流動力電源及び原子炉補機冷却機能が健全である場合の炉心注水として、燃料取替用水ビットを水源とする充てんポンプは、化学体積制御システムにより炉心へ注水できる設計とする。</p> <p>運転中の1次冷却材喪失事象時において、余熱除去ポンプ及び高圧注入ポンプの故障等により炉心注水機能が喪失した場合、運転中の1次冷却材喪失事象時において、余熱除去ポンプ若しくは高圧注入ポンプによる再循環又はB-格納容器スプレイポンプによる代替再循環で格納容器再循環サンブスクリーン閉塞の兆候が見られた場合、運転停止中において、余熱除去ポンプ又は余熱除去冷却器の故障等により余熱除去設備による崩壊熱除去機能が喪失した場合並びに原子炉の冷却機能が喪失し、炉心の著しい損傷が発生した場合であって交流動力電源及び原子炉補機冷却機能が健全である場合の代替炉心注水として、燃料取替用水ビットを水源とするB-格納容器スプレイポンプは、格納容器スプレイ系統と余熱除去系統間の連絡ラインを介して炉心へ注水できる設計とする。</p> <p>運転中の1次冷却材喪失事象時において、余熱除去ポンプ及び高圧注入ポンプの故障等により炉心注水機能が喪失した場合、運転中の1次冷却材喪失事象時において、余熱除去ポンプ若しくは高圧注入ポンプによる再循環又はB-格納容器スプレイポンプによる代替再循環で格納容器再循環サンブスクリーン閉塞の兆候が見られた場合、運転中の1次冷却材喪失事象時において、全交流動力電源又は原子炉補機冷却機能が喪失した場合、運転停止中において、余熱除去ポンプ又は余熱除去冷却器の故障等により余熱除去設備による崩壊熱除去機能が喪失した場合、運転停止中において、全交流動力電源又は原子炉補機冷却機能が喪失した場合並びに原子炉の冷却機能が喪失し、炉心の著しい損傷が発生した場合の代替炉心注水として、燃料取替用水ビット又は補助給水ビットを水源とする代替格納容器スプレイポンプは、格納容器スプレイ系統と余熱除去系統間の連絡ラインを介して炉心へ注水できる設計とする。</p> </div>	

赤字：設備、運用又は体制の相違（設計方針の相違）  
 青字：記載箇所又は記載内容の相違（記載方針の相違）  
 緑字：記載表現、設備名称の相違（実質的な相違なし）

第51条 原子炉格納容器下部の溶融炉心を冷却するための設備

大飯発電所3 / 4号炉	泊発電所3号炉	相違理由
	<p style="text-align: center;">容-2(4/8)</p> <div style="border: 1px solid black; padding: 5px;"> <p>運転中の1次冷却材喪失事象時において、余熱除去ポンプ若しくは高圧注入ポンプによる再循環又はB-格納容器スプレイポンプによる代替再循環で格納容器再循環サンブスクリーン閉塞の兆候が見られた場合、運転停止中において余熱除去ポンプ又は余熱除去冷却器の故障等により余熱除去設備による崩壊熱除去機能が喪失した場合並びに原子炉の冷却機能が喪失し、炉心の著しい損傷が発生した場合であって交流動力電源及び原子炉補機冷却機能が健全である場合の炉心注水として、燃料取替用水ビットを水源とした高圧注入ポンプは、安全注入系統により炉心へ注水できる設計とする。</p> <p>運転中の1次冷却材喪失事象時において、全交流動力電源又は原子炉補機冷却機能が喪失した場合、運転停止中において、全交流動力電源又は原子炉補機冷却機能が喪失した場合並びに原子炉の冷却機能が喪失し、炉心の著しい損傷が発生した場合であって全交流動力電源又は原子炉補機冷却機能が喪失した場合の代替炉心注水として、燃料取替用水ビットを水源とするB-充てんポンプは、自己冷却ラインを用いることにより運転でき、化学体積制御系により炉心へ注水できる設計とする。</p> <p>炉心の著しい損傷、溶融が発生した場合において、原子炉容器に残存溶融デブリが存在する場合の格納容器スプレイとして、燃料取替用水ビットを水源とする格納容器スプレイポンプは、原子炉格納容器内上部にあるスプレイリングのスプレイノズルより注水できる設計とする。</p> <p>炉心の著しい損傷、溶融が発生した場合において、原子炉容器に残存溶融デブリが存在する場合の代替格納容器スプレイとして、燃料取替用水ビット又は補助給水ビットを水源とする代替格納容器スプレイポンプは、格納容器スプレイ系統を介して、原子炉格納容器内上部にあるスプレイリングのスプレイノズルより注水できる設計とする。</p> <p>原子炉の冷却機能が喪失し、炉心の著しい損傷が発生した場合であって交流動力電源及び原子炉補機冷却機能が健全である場合の炉心注水として、燃料取替用水ビットを水源とする余熱除去ポンプは、低圧注入系統により炉心へ注水できる設計とする。</p> <p>これらの系統構成については、設備別記載事項の設定根拠に関する説明書別添3「技術基準規則第62条系統図」による。</p> </div>	

赤字：設備、運用又は体制の相違（設計方針の相違）  
 青字：記載箇所又は記載内容の相違（記載方針の相違）  
 緑字：記載表現、設備名称の相違（実質的な相違なし）

第51条 原子炉格納容器下部の溶融炉心を冷却するための設備

大飯発電所3/4号炉	泊発電所3号炉	相違理由
	<p style="text-align: center;">容-2(5/8)</p> <div style="border: 1px solid black; padding: 5px;"> <p>燃料取替用水ビットは、炉心の著しい損傷が発生した場合において原子炉格納容器の破損を防止するため、溶融し、原子炉格納容器の下部に落下した炉心を冷却するために設置する。</p> <p>系統構成は、炉心の著しい損傷が発生した場合であって交流動力電源及び原子炉補機冷却機能が健全である場合の格納容器スプレイトとして、燃料取替用水ビットを水源とした格納容器スプレイトポンプは、原子炉格納容器内上部にあるスプレイトリングのスプレイトノズルより注水し、格納容器スプレイト水が原子炉格納容器とフロア最外周部間の隙間等を通じ原子炉格納容器最下階フロアまで流下し、さらに連通管及び小扉を経由して原子炉下部キャビティへ流入することで、溶融炉心が落下するまでに原子炉下部キャビティに十分な水量を蓄水できる設計とする。</p> <p>炉心の著しい損傷が発生した場合の代替格納容器スプレイトとして、燃料取替用水ビット又は補助給水ビットを水源とする代替格納容器スプレイトポンプは、格納容器スプレイト系統を介して、原子炉格納容器内上部にあるスプレイトリングのスプレイトノズルより注水し、代替格納容器スプレイト水が原子炉格納容器とフロア最外周部間の隙間等を通じ原子炉格納容器最下階フロアまで流下し、さらに連通管及び小扉を経由して原子炉下部キャビティへ流入することで、溶融炉心が落下するまでに原子炉下部キャビティに十分な水量を蓄水できる設計とする。</p> <p>これらの系統構成については、設備別記載事項の設定根拠に関する説明書別添3「技術基準規則第66条系統図」による。</p> <p>燃料取替用水ビットは、設計基準事故の収束に必要な水源とは別に、重大事故等の収束に必要な十分な量の水を有する水源を確保することに加えて、原子炉施設には、設計基準事故対処設備及び重大事故等対処設備に対して重大事故等の収束に必要な十分な量の水を供給するために設置する。</p> <p>系統構成は、重大事故等により、蒸気発生器2次側への注水手段の水源となる補助給水ビットが枯渇又は破損した場合の代替手段である1次系のフィードアンドブリードの水源として、代替水源である非常用炉心冷却設備の燃料取替用水ビットを使用する。</p> <p>これらの系統構成については、設備別記載事項の設定根拠に関する説明書別添3「技術基準規則第71条系統図」による。</p> </div>	

赤字：設備、運用又は体制の相違（設計方針の相違）  
 青字：記載箇所又は記載内容の相違（記載方針の相違）  
 緑字：記載表現、設備名称の相違（実質的な相違なし）

第51条 原子炉格納容器下部の溶融炉心を冷却するための設備

大飯発電所3/4号炉	泊発電所3号炉	相違理由
	<p style="text-align: center;">容-2(6/8)</p> <div style="border: 1px solid black; padding: 5px;"> <p>重大事故等時に計測制御系統施設のうちほう酸注入機能を有する設備として使用する燃料取替用水ピットは、以下の機能を有する。</p> <p>燃料取替用水ピットは、運転時の異常な過渡変化時において原子炉の運転を緊急に停止することができない事象が発生するおそれがある場合又は当該事象が発生した場合においても炉心の著しい損傷を防止するため、原子炉冷却材圧力バウンダリ及び原子炉格納容器の健全性を維持するとともに、原子炉を未臨界に移行するために設置する。</p> <p>系統構成は、ほう酸ポンプが故障により使用できない場合のほう酸水注入として、燃料取替用水ピットを水源とした充てんポンプは、化学体積制御系統により、炉心に十分な量のほう酸水を注入できる設計とする。さらに、充てんポンプが使用できない場合のほう酸水注入として、燃料取替用水ピットを水源とした高圧注入ポンプは、ほう酸注入タンクを介して炉心に十分な量のほう酸水を注入できる設計とする。</p> <p>これらの系統構成については、設備別記載事項の設定根拠に関する説明書別添3「技術基準規則第59条系統図」による。</p> <p>重大事故等時に原子炉格納施設のうち圧力低減設備その他の安全設備として使用する燃料取替用水ピットは、以下の機能を有する。</p> <p>燃料取替用水ピットは、設計基準事故対処設備が有する原子炉格納容器内の冷却機能が喪失した場合において炉心の著しい損傷を防止するため、原子炉格納容器内の圧力及び温度を低下させるために設置する。また、炉心の著しい損傷が発生した場合において原子炉格納容器の破損を防止するため、原子炉格納容器内の圧力及び温度並びに放射性物質の濃度を低下させるために設置する。</p> </div>	



赤字：設備、運用又は体制の相違（設計方針の相違）  
 青字：記載箇所又は記載内容の相違（記載方針の相違）  
 緑字：記載表現、設備名称の相違（実質的な相違なし）

第51条 原子炉格納容器下部の溶融炉心を冷却するための設備

大飯発電所3 / 4号炉	泊発電所3号炉	相違理由
	<p style="text-align: center;">容-2(7/8)</p> <div style="border: 1px solid black; padding: 5px;"> <p>系統構成は、1次冷却材喪失事象時において、格納容器スプレイポンプ又は燃料取替用水ビットの故障等により原子炉格納容器内の冷却機能が喪失した場合、全交流動力電源又は原子炉補機冷却機能が喪失した場合、1次冷却材喪失事象時に格納容器スプレイポンプ又は燃料取替用水ビットの故障等により原子炉格納容器内の冷却機能が喪失し、炉心の著しい損傷が発生した場合並びに全交流動力電源又は原子炉補機冷却機能が喪失し、炉心の著しい損傷が発生した場合の代替格納容器スプレイとして、燃料取替用水ビット又は補助給水ビットを水源とする代替格納容器スプレイポンプは、格納容器スプレイ系統を介して、原子炉格納容器内上部にあるスプレイリングのスプレイノズルより原子炉格納容器内にスプレイできる設計とする。</p> <p>これらの系統構成については、設備別記載事項の設定根拠に関する説明書別添3「技術基準規則第64条系統図」による。</p> <p>燃料取替用水ビットは、炉心の著しい損傷が発生した場合において原子炉格納容器の破損を防止するため、原子炉格納容器内の圧力及び温度を低下させるために設置する。</p> <p>系統構成は、炉心の著しい損傷が発生した場合であって交流動力電源及び原子炉補機冷却機能が健全である場合の格納容器スプレイとして、燃料取替用水ビットを水源とする格納容器スプレイポンプは、原子炉格納容器内上部にあるスプレイリングのスプレイノズルより原子炉格納容器内にスプレイできる設計とする。</p> <p>炉心の著しい損傷が発生した場合の代替格納容器スプレイとして、燃料取替用水ビット又は補助給水ビットを水源とする代替格納容器スプレイポンプは、格納容器スプレイ系統を介して、原子炉格納容器内上部にあるスプレイリングのスプレイノズルより原子炉格納容器内にスプレイできる設計とする。</p> <p>これらの系統構成については、設備別記載事項の設定根拠に関する説明書別添3「技術基準規則第65条系統図」による。</p> <p>1. 容量</p> <p>設計基準対象施設のその他発電用原子炉の附属施設（火災防護設備）のうち消火設備として使用する燃料取替用水ビットの容量は、原子炉冷却系等施設としての設計基準対象施設と同仕様で設計し、<span style="border: 1px solid black; display: inline-block; width: 20px; height: 10px;"></span>以上とする。</p> </div> <p style="text-align: center;"><span style="border: 1px solid black; display: inline-block; width: 20px; height: 10px;"></span> 枠囲みの内容は機密情報に属しますので公開できません。</p>	

赤字：設備、運用又は体制の相違（設計方針の相違）  
 青字：記載箇所又は記載内容の相違（記載方針の相違）  
 緑字：記載表現、設備名称の相違（実質的な相違なし）

第51条 原子炉格納容器下部の溶融炉心を冷却するための設備

大飯発電所3 / 4号炉	泊発電所3号炉	相違理由
	<p style="text-align: right;">容-2(8/8)</p> <div style="border: 1px solid black; padding: 5px;"> <p>燃料取替用水ビットを重大事故等時において代替格納容器スプレイポンプ等による炉心注入の水源として使用する場合の容量は、有効性評価において格納容器スプレイポンプによる代替再循環運転又は高圧注入ポンプによる高圧再循環運転、可搬型大型送水ポンプ車及び格納容器再循環ユニットによる格納容器内自然対流冷却へ移行可能な容量 <math>\square</math> m<sup>3</sup>(注1)が確認されている。</p> <p>また、燃料取替用水ビットを重大事故等時において代替格納容器スプレイポンプによる格納容器スプレイの水源として使用する場合の容量は、有効性評価において可搬型大型送水ポンプ車による燃料取替用水ビットへの補給と合わせて、事故後24時間までに可搬型大型送水ポンプ車、格納容器再循環ユニットによる格納容器内自然対流冷却へ移行可能な容量 <math>\square</math> m<sup>3</sup>(注1)が確認されている。</p> <p>以上より、燃料取替用水ビットを重大事故等時に使用する場合の容量は、<math>\square</math> m<sup>3</sup>/個とする。</p> <p>公称値については、要求される容量 <math>\square</math> m<sup>3</sup>/個を上回る2,000m<sup>3</sup>/個とする。</p> <p>2. 最高使用圧力</p> <p>設計基準対象施設として使用する燃料取替用水ビットの最高使用圧力は、燃料取替用水ビットが大気開放であることから大気圧とする。</p> <p>燃料取替用水ビットを重大事故等時において使用する場合の圧力は、燃料取替用水ビットが大気開放であることから、設計基準対象施設と同仕様で設計し、大気圧とする。</p> <p>3. 最高使用温度</p> <p>設計基準対象施設として使用する燃料取替用水ビットの最高使用温度は、燃料取替用水ビットの通常運転温度が約30℃であるため、これを上回る温度として95℃とする。</p> <p>燃料取替用水ビットを重大事故等時において使用する場合の温度は、燃料取替用水ビットの通常運転温度が約30℃であることから、設計基準対象施設と同仕様で設計し、30℃を上回る95℃とする。</p> <p>(注1) 燃料取替用水ビットの有効水量</p> </div> <p style="text-align: center;"><math>\square</math> 枠囲みの内容は機密情報に属しますので公開できません。</p>	

赤字：設備、運用又は体制の相違（設計方針の相違）  
 青字：記載箇所又は記載内容の相違（記載方針の相違）  
 緑字：記載表現、設備名称の相違（実質的な相違なし）

第51条 原子炉格納容器下部の溶融炉心を冷却するための設備

大飯発電所3/4号炉	泊発電所3号炉	相違理由																																				
<table border="1" data-bbox="259 306 965 486"> <thead> <tr> <th>名称</th> <th colspan="2">恒設代替低圧注水ポンプ</th> </tr> </thead> <tbody> <tr> <td>容量<sup>(注1)</sup></td> <td>m<sup>3</sup>/h/個</td> <td>110 以上、130 以上<sup>(注2)</sup> (150<sup>(注3)</sup>)</td> </tr> <tr> <td>揚程<sup>(注1)</sup></td> <td>m</td> <td>□ 以上、□ 以上<sup>(注2)</sup> (150<sup>(注3)</sup>)</td> </tr> <tr> <td>最高使用圧力<sup>(注1)</sup></td> <td>MPa</td> <td>□</td> </tr> <tr> <td>最高使用温度<sup>(注1)</sup></td> <td>℃</td> <td>95</td> </tr> <tr> <td>原動機出力</td> <td>kW/個</td> <td>□</td> </tr> </tbody> </table> <p>(注1) 重大事故等時における使用時の値                  (注2) 原子炉格納施設のうち圧力低減設備その他の安全設備（格納容器安全設備）で使用する場合の値                  (注3) 公称値</p> <p><b>【設定根拠】</b></p> <ul style="list-style-type: none"> <li>・重大事故等対処設備</li> </ul> <p>重大事故等時に原子炉冷却系統施設のうち非常用炉心冷却設備その他原子炉注水設備として炉心注水時に使用する恒設代替低圧注水ポンプは、以下の機能を有する。</p> <p>恒設代替低圧注水ポンプは、原子炉冷却材圧力バウンダリが低圧の状態であって、設計基準事故対処設備が有する発電用原子炉の冷却機能が喪失した場合においても炉心の著しい損傷及び原子炉格納容器の破損を防止するため、発電用原子炉を冷却するために設置する。</p> <p>系統構成は、運転中の1次冷却材喪失事象時において、余熱除去ポンプ及び高圧注入ポンプの故障等により炉心注水機能が喪失した場合に燃料取替用水ビット又は復水ビットを水源とする恒設代替低圧注水ポンプより、格納容器スプレイ系統と余熱除去系統間の連絡ラインを介して原子炉へ注水することにより炉心の著しい損傷及び原子炉格納容器の破損を防止する設計とする。</p> <p>また、炉心の著しい損傷が発生した場合には、同様の運転にて溶融炉心の原子炉容器下部への落下を遅延・防止することで原子炉格納容器の損傷を防止する設計とする。</p> <p>恒設代替低圧注水ポンプは、設計基準事故の取束に必要な水源とは別に、重大事故等の取束に必要な十分な量の水を有する水源を確保することに加えて、発電用原子炉施設には、設計基準事故対処設備及び重大事故等対処設備に対して重大事故等の取束に必要と</p> <p style="border: 1px solid black; padding: 2px;">枠囲みの範囲は機密に係る事項のため公開することはできません。</p>	名称	恒設代替低圧注水ポンプ		容量 <sup>(注1)</sup>	m <sup>3</sup> /h/個	110 以上、130 以上 <sup>(注2)</sup> (150 <sup>(注3)</sup> )	揚程 <sup>(注1)</sup>	m	□ 以上、□ 以上 <sup>(注2)</sup> (150 <sup>(注3)</sup> )	最高使用圧力 <sup>(注1)</sup>	MPa	□	最高使用温度 <sup>(注1)</sup>	℃	95	原動機出力	kW/個	□	<p style="text-align: center;">容-5(1/7)</p> <table border="1" data-bbox="1169 306 1874 486"> <thead> <tr> <th>名称</th> <th colspan="2">代替格納容器スプレイポンプ</th> </tr> </thead> <tbody> <tr> <td>容量</td> <td>m<sup>3</sup>/h/個</td> <td>□ 以上、□ 以上(150)</td> </tr> <tr> <td>揚程</td> <td>m</td> <td>□ 以上、□ 以上(300)</td> </tr> <tr> <td>最高使用圧力</td> <td>MPa</td> <td>4.1</td> </tr> <tr> <td>最高使用温度</td> <td>℃</td> <td>95</td> </tr> <tr> <td>原動機出力</td> <td>kW/個</td> <td>200以上</td> </tr> </tbody> </table> <p>原子炉格納施設のうち圧力低減その他の安全設備に係るものと兼用</p> <p><b>【設定根拠】</b></p> <ul style="list-style-type: none"> <li>・重大事故等対処設備</li> </ul> <p>重大事故等時に原子炉冷却系統施設のうち非常用炉心冷却設備その他原子炉注水設備及び原子炉格納施設のうち圧力低減その他の安全設備に係るものとして使用する代替格納容器スプレイポンプは、以下の機能を有する。</p> <p>重大事故時に原子炉冷却系統施設のうち非常用炉心冷却設備として使用する代替格納容器スプレイポンプは、原子炉冷却材圧力バウンダリが低圧時に原子炉を冷却するための設備のうち、炉心を冷却し、炉心の著しい損傷及び原子炉格納容器の破損を防止するため及び、炉心の著しい損傷に至るまでの時間的余裕のない場合に対応するために設置する。</p> <p>系統構成は、燃料取替用水ビット又は補助給水ビットを水源とする代替格納容器スプレイポンプは、格納容器スプレイ系統と余熱除去系統間の連絡ラインを介して炉心へ注水できる設計とする。これらの系統構成については、設備別記載事項の設定根拠に関する説明書別添3「技術基準規則 第62条系統図」による。</p> <p>重大事故時に原子炉冷却系統施設のうち非常用炉心冷却設備として使用する代替格納容器スプレイポンプは、炉心の著しい損傷、溶融が発生した場合において、原子炉容器に残存溶融デブリが存在する場合、原子炉格納容器水張り（格納容器スプレイ）により残存溶融デブリを冷却し、原子炉格納容器の破損を防止するための設備として設置する。</p> <p>系統構成は、燃料取替用水ビット又は補助給水ビットを水源とする代替格納容器スプレイポンプは、格納容器スプレイ系統を介して、原子炉格納容器内上部にあるスプレイリングのスプレイノズルより注水できる設計とする。これらの系統構成については、設備別記載事項</p> <p style="text-align: right;">□ 枠囲みの内容は機密情報に属しますので公開できません。</p>	名称	代替格納容器スプレイポンプ		容量	m <sup>3</sup> /h/個	□ 以上、□ 以上(150)	揚程	m	□ 以上、□ 以上(300)	最高使用圧力	MPa	4.1	最高使用温度	℃	95	原動機出力	kW/個	200以上	
名称	恒設代替低圧注水ポンプ																																					
容量 <sup>(注1)</sup>	m <sup>3</sup> /h/個	110 以上、130 以上 <sup>(注2)</sup> (150 <sup>(注3)</sup> )																																				
揚程 <sup>(注1)</sup>	m	□ 以上、□ 以上 <sup>(注2)</sup> (150 <sup>(注3)</sup> )																																				
最高使用圧力 <sup>(注1)</sup>	MPa	□																																				
最高使用温度 <sup>(注1)</sup>	℃	95																																				
原動機出力	kW/個	□																																				
名称	代替格納容器スプレイポンプ																																					
容量	m <sup>3</sup> /h/個	□ 以上、□ 以上(150)																																				
揚程	m	□ 以上、□ 以上(300)																																				
最高使用圧力	MPa	4.1																																				
最高使用温度	℃	95																																				
原動機出力	kW/個	200以上																																				

赤字：設備、運用又は体制の相違（設計方針の相違）  
 青字：記載箇所又は記載内容の相違（記載方針の相違）  
 緑字：記載表現、設備名称の相違（実質的な相違なし）

第51条 原子炉格納容器下部の溶融炉心を冷却するための設備

大飯発電所3/4号炉	泊発電所3号炉	相違理由
<p>なる十分な量の水を供給するために設置する。</p> <p>系統構成は、燃料取替用水ピット又は復水ピットを水源とする恒設代替低圧注水ポンプより、格納容器スプレイ系統と余熱除去系統間の連絡ラインを介して原子炉へ注水することができる設計とする。</p> <p>重大事故等時に原子炉冷却系統施設のうち非常用炉心冷却設備その他原子炉注水設備として格納容器スプレイ時に使用する恒設代替低圧注水ポンプは、以下の機能を有する。</p> <p>恒設代替低圧注水ポンプは、原子炉冷却材圧力バウンダリが低圧の状態であって、設計基準事故対処設備が有する発電用原子炉の冷却機能が喪失した場合においても炉心の著しい損傷及び原子炉格納容器の破損を防止するため、発電用原子炉を冷却するために設置する。</p> <p>系統構成は、炉心の著しい損傷、溶融が発生した場合において、原子炉容器に残存溶融デブリが存在する場合、原子炉格納容器水張り（格納容器スプレイ）により残存溶融デブリを冷却するため、燃料取替用水ピット又は復水ピットを水源とした恒設代替低圧注水ポンプにより、格納容器スプレイ系統を介して原子炉格納容器上部にあるスプレイリングのスプレイノズルからの注水により原子炉格納容器内に水を張ることで残存溶融デブリの冷却を行い、原子炉格納容器の破損を防止する設計とする。</p> <p>重大事故等時に原子炉格納施設のうち圧力低減設備その他の安全設備として使用する恒設代替低圧注水ポンプは、以下の機能を有する。</p> <p>恒設代替低圧注水ポンプは、設計基準事故対処設備が有する原子炉格納容器内の冷却機能が喪失した場合において炉心の著しい損傷を防止するため、原子炉格納容器内の圧力及び温度を低下させるため、また、炉心の著しい損傷が発生した場合において原子炉格納容器の破損を防止するため、原子炉格納容器内の圧力及び温度並びに放射性物質の濃度を低下させるために設置する。</p> <p>恒設代替低圧注水ポンプは、炉心の著しい損傷が発生した場合において原子炉格納容器の破損を防止するため、原子炉格納容器内の圧力及び温度を低下させるために設置する。</p> <p>これらの系統構成は、1次系冷却材喪失事象時において格納容器スプレイポンプ及び燃料取替用水ピットの故障等により原子炉格納容器内の冷却機能が喪失した場合に燃料取替用水ピット又は復水ピットを水源とする恒設代替低圧注水ポンプにより、格納容器スプレイ系統</p> <p style="border: 1px solid black; padding: 2px;">枠囲みの範囲は機密に係る事項のため公開することはできません。</p>	<p style="text-align: center;">容-5(2/7)</p> <p>の設定根拠に関する説明書別添3「技術基準規則 第62条系統図」による。</p> <p>重大事故時に原子炉冷却系統施設のうち非常用炉心冷却設備として使用する代替格納容器スプレイポンプは、原子炉の冷却機能が喪失し、炉心の著しい損傷が発生した場合に溶融炉心の原子炉格納容器下部への落下を遅延・防止することで、原子炉格納容器の破損を防止する設備として設置する。</p> <p>系統構成は、燃料取替用水ピット又は補助給水ピットを水源とする代替格納容器スプレイポンプは、格納容器スプレイ系統と余熱除去系統間の連絡ラインを介して炉心へ注水できる設計とする。これらの系統構成については、設備別記載事項の設定根拠に関する説明書別添3「技術基準規則 第62条系統図」による。</p> <p>重大事故時に原子炉格納施設のうち圧力低減設備その他の安全設備に係るものとして使用する代替格納容器スプレイポンプは、原子炉格納容器内の冷却等のための設備のうち、炉心の著しい損傷を防止するため、原子炉格納容器内の圧力及び温度を低下させるために設置する。</p> <p>系統構成は、燃料取替用水ピット又は補助給水ピットを水源とする代替格納容器スプレイポンプは、格納容器スプレイ系統を介して、原子炉格納容器内上部にあるスプレイリングのスプレイノズルより原子炉格納容器内にスプレイできる設計とする。これらの系統構成については、設備別記載事項の設定根拠に関する説明書別添3「技術基準規則 第64条系統図」による。</p> <p>重大事故時に原子炉格納施設のうち圧力低減設備その他の安全設備に係るものとして使用する代替格納容器スプレイポンプは、原子炉格納容器内の冷却等のための設備のうち、炉心の著しい損傷が発生した場合において原子炉格納容器の破損を防止するため、原子炉格納容器内の圧力及び温度並びに放射性物質の濃度を低下させるために設置する。</p> <p>系統構成は、燃料取替用水ピット又は補助給水ピットを水源とする代替格納容器スプレイポンプは、格納容器スプレイ系統を介して、原子炉格納容器内上部にあるスプレイリングのスプレイノズルより原子炉格納容器内にスプレイできる設計とする。これらの系統構成については、設備別記載事項の設定根拠に関する説明書別添3「技術基準規則 第64条系統図」による。</p>	

赤字：設備、運用又は体制の相違（設計方針の相違）  
 青字：記載箇所又は記載内容の相違（記載方針の相違）  
 緑字：記載表現、設備名称の相違（実質的な相違なし）

第51条 原子炉格納容器下部の溶融炉心を冷却するための設備

大飯発電所3/4号炉	泊発電所3号炉	相違理由
<p>を介して原子炉格納容器上部にあるスプレイリングのスプレイノズルより原子炉格納容器内にスプレイすることにより圧力及び温度を低下させる設計とする。</p> <p>また、炉心の著しい損傷が発生した場合には、同様の運転にて原子炉格納容器内の圧力及び温度並びに放射性物質の濃度を低下させる設計とする。</p> <p>恒設代替低圧注水ポンプは、炉心の著しい損傷が発生した場合において原子炉格納容器の破損を防止するため、溶融し、原子炉格納容器の下部に落下した炉心を冷却するために設置する。</p> <p>系統構成は、燃料取替用水ピット又は復水ピットを水源とする恒設代替低圧注水ポンプより、格納容器スプレイ系統を介して原子炉格納容器内上部にあるスプレイリングのスプレイノズルより原子炉格納容器内に注水し、代替格納容器スプレイ水が格納容器とフロア最外周部間の隙間等を通じ、格納容器最下階フロアまで流下し、さらに連通穴を経由して原子炉下部キャビティへ流入することで、溶融炉心が落下するまでに原子炉下部キャビティに十分な水量を蓄水することにより原子炉格納容器の破損を防止する設計とする。</p> <p>恒設代替低圧注水ポンプは、設計基準事故の収束に必要な水源とは別に、重大事故等の収束に必要な十分な量の水を有する水源を確保することに加えて、発電用原子炉施設には、設計基準事故対処設備及び重大事故等対処設備に対して重大事故等の収束に必要な十分な量の水を供給するために設置する。</p> <p>系統構成は、燃料取替用水ピット又は復水ピットを水源とする恒設代替低圧注水ポンプより、格納容器スプレイ系統を介して、原子炉格納容器上部にあるスプレイリングのスプレイノズルより原子炉格納容器内にスプレイできる設計とする。</p> <p>恒設代替低圧注水ポンプの設置個数は、1個とする。</p> <p>1. 容量</p> <p>1.1 原子炉に注水する場合の容量（110m<sup>3</sup>/h/個以上）</p> <p>原子炉冷却系統施設のうち非常用炉心冷却設備その他原子炉注水設備として炉心注水に使用する恒設代替低圧注水ポンプの容量は、炉心の著しい損傷の防止の重要事故シーケンスのうち、中破断LOCA時に高圧注入機能が喪失する事故のうち破断口が小さい場合</p> <p style="border: 1px solid black; padding: 2px;">枠囲みの範囲は機密に係る事項のため公開することはできません。</p>	<p style="text-align: center;">容-5(3/7)</p> <p>重大事故時に原子炉格納施設のうち圧力低減設備その他の安全設備に係るものとして使用する代替格納容器スプレイポンプは、原子炉格納容器の過圧破損を防止するための設備のうち、炉心の著しい損傷が発生した場合に原子炉格納容器内の圧力及び温度を低下させるために設置する。</p> <p>系統構成は、燃料取替用水ピット又は補助給水ピットを水源とする代替格納容器スプレイポンプは、格納容器スプレイ系統を介して、原子炉格納容器内上部にあるスプレイリングのスプレイノズルより原子炉格納容器内にスプレイできる設計とする。設備別記載事項の設定根拠に関する説明書別添3「技術基準規則 第65条系統図」による。</p> <p>重大事故時に原子炉格納施設のうち圧力低減設備その他の安全設備に係るものとして使用する代替格納容器スプレイポンプは、原子炉格納容器下部の溶融炉心を冷却するための設備のうち、炉心の著しい損傷が発生した場合に原子炉格納容器の下部に落下した溶融炉心を冷却するために設置する。</p> <p>系統構成は、燃料取替用水ピット又は補助給水ピットを水源とする代替格納容器スプレイポンプは、格納容器スプレイ系統を介して、原子炉格納容器内上部にあるスプレイリングのスプレイノズルより注水し、代替格納容器スプレイ水が原子炉格納容器とフロア最外周部間の隙間等を通じ、原子炉格納容器最下階フロアまで流下し、さらに小扉及び連通穴を経由して原子炉下部キャビティへ流入することで、溶融炉心が落下するまでに原子炉下部キャビティに十分な水量を蓄水できる設計とする。これらの系統構成については、設備別記載事項の設定根拠に関する説明書別添3「技術基準規則 第66条系統図」による。</p> <p>重大事故時に原子炉冷却系統施設のうち非常用炉心冷却設備及び原子炉格納施設のうち圧力低減設備その他の安全設備に係るものとして使用する代替格納容器スプレイポンプは、重大事故等の収束に必要な水の供給設備のうち、設計基準事故の収束に必要な水源とは別に、重大事故等の収束に必要な十分な量の水を有する水源を確保することに加えて、原子炉施設には、設計基準事故対処設備及び重大事故等対処設備に対して重大事故等の収束に必要な十分な量の水を供給するために設置する。</p> <p>系統構成は、代替格納容器スプレイポンプの電源は全交流動力電源が喪失した場合においても代替電源設備である空冷式非常用発電装置より、代替所内電気設備変圧器を経由して給電できる設計とする。これらの系統構成については、設備別記載事項の設定根拠に関する説明書別添3「技術基準規則 第71条系統図」による。</p>	

赤字：設備、運用又は体制の相違（設計方針の相違）  
 青字：記載箇所又は記載内容の相違（記載方針の相違）  
 緑字：記載表現、設備名称の相違（実質的な相違なし）

第51条 原子炉格納容器下部の溶融炉心を冷却するための設備

大飯発電所3/4号炉	泊発電所3号炉	相違理由
<p style="text-align: center;">大飯発電所3/4号炉</p> <div style="border: 1px solid black; padding: 5px; margin: 10px 0;"> <p>において、1次冷却材の保有水量を確保し、蒸気発生器において2次冷却材との熱交換を行い、主蒸気逃がし弁を開として2次系強制冷却を行うことで炉心崩壊熱を除去する場合に、有効性評価解析（原子炉設置変更許可申請書添付書類十）において有効性が確認されている原子炉への注水流量が110m<sup>3</sup>/hのため110m<sup>3</sup>/h/個以上とする。</p> <p>1.2 原子炉格納容器内にスプレイする場合の容量（130m<sup>3</sup>/h/個以上）</p> <p>原子炉格納施設のうち圧力低減設備その他の安全設備又は、原子炉冷却系統施設のうち非常用炉心冷却設備その他原子炉注水設備として格納容器スプレイ時に使用する恒設代替低圧注水ポンプの容量は、原子炉格納容器の破損の防止の重要事故シナリオのうち、大破断LOCA+非常用炉心冷却設備注水失敗+格納容器スプレイ失敗事象などの格納容器過圧破損事象や、全交流動力電源喪失+補助給水機能喪失などの格納容器過温破損事象などにおいて、燃料取替用水ビット又は復水ビットから、ほう酸水又は淡水を原子炉格納容器内にスプレイし、原子炉格納容器内の放射性物質濃度及び圧力を低下させるために必要な容量を基に設定する。</p> <p>原子炉格納施設のうち圧力低減設備その他の安全設備又は、原子炉冷却系統施設のうち非常用炉心冷却設備その他原子炉注水設備として使用する恒設代替低圧注水ポンプの容量は、130m<sup>3</sup>/hの流量にて評価した結果、原子炉格納容器内の放射性物質濃度を低下させるために、エアロゾル除去効果が確認されているスプレイ液滴径を満足し、格納容器過圧破損事象において原子炉格納容器内の最高圧力が0.43MPaとなり、また、格納容器過温破損事象において原子炉格納容器内の最高温度が144℃となることから、重大事故対策の有効性評価解析（原子炉設置変更許可申請書添付書類十）において、放射性物質濃度を低下させ、代替最終ヒートシンクによる格納容器の除熱手段確立までの間、原子炉格納容器内の圧力を原子炉格納容器の最高使用圧力近傍で維持することが可能である流量130m<sup>3</sup>/h/個以上を当該ポンプの容量とする。</p> <p>公称値については、要求される最大容量130m<sup>3</sup>/hを上回る150m<sup>3</sup>/h/個とする。</p> <p>2. 揚程</p> <p>2.1 原子炉に注水する場合の揚程（<input type="text" value="0.5"/>m以上）</p> <p>原子炉冷却系統施設のうち非常用炉心冷却設備その他原子炉注水設備として炉心注水時に使用する恒設代替低圧注水ポンプの揚程は、ほう酸水及び淡水を原子炉に注水する場合の水源と移送先の圧力差、静水頭、機器圧損、配管及び弁類圧損を基に設定する。</p> </div> <div style="border: 1px solid black; padding: 2px; margin-top: 10px; text-align: center;"> <p>枠囲みの範囲は機密に係る事項のため公開することはできません。</p> </div>	<p style="text-align: center;">泊発電所3号炉</p> <p style="text-align: right;">容-5(4/7)</p> <div style="border: 1px solid black; padding: 5px; margin: 10px 0;"> <p>代替格納容器スプレイポンプの設置個数は、1個とする。</p> <p>1. 容量</p> <p>1.1 原子炉に注入する場合の容量 <input type="text" value="0.5"/>m<sup>3</sup>/h/個以上</p> <p>原子炉冷却系統施設のうち非常用炉心冷却設備その他原子炉注水設備として炉心注水時に使用する代替格納容器スプレイポンプの容量は、炉心の著しい損傷の防止の重要事故シナリオのうち、外部電源喪失時に非常用所内交流動力電源が喪失し、原子炉捕機冷却機能の喪失及びRCPシールLOCAが発生する事故において、1次冷却材の保有水量を確保し、蒸気発生器において2次冷却材との熱交換を行い、主蒸気逃がし弁を開として2次系強制冷却を行うことで炉心崩壊熱を除去する場合に、有効性評価解析（原子炉設置変更許可申請書添付書類十）において有効性が確認されている原子炉への注水流量が<input type="text" value="0.5"/>m<sup>3</sup>/hのため<input type="text" value="0.5"/>m<sup>3</sup>/h/個以上とする。</p> <p>1.2 原子炉格納容器内にスプレイする場合の容量 <input type="text" value="0.5"/>m<sup>3</sup>/h/個以上</p> <p>原子炉格納施設のうち圧力低減設備その他の安全設備又は、原子炉冷却系統施設のうち非常用炉心冷却設備その他原子炉注水設備として格納容器スプレイ時に使用する代替格納容器スプレイポンプの容量は、原子炉格納容器の破損の防止の重要事故シナリオのうち、大破断LOCA+非常用炉心冷却設備注水失敗+格納容器スプレイ失敗事象などの格納容器過圧破損事象や、全交流動力電源喪失+補助給水機能喪失などの格納容器過温破損事象などにおいて、燃料取替用水ビット又は補助給水ビットから、ほう酸水又は淡水を原子炉格納容器内にスプレイし、原子炉格納容器内の圧力を、原子炉格納容器の最高使用圧力近傍で維持するために必要な容量を基に設定する。</p> <p>原子炉格納施設のうち圧力低減設備その他の安全設備として使用する代替格納容器スプレイポンプの容量は、格納容器過圧破損事象において<input type="text" value="0.5"/>m<sup>3</sup>/hの流量にて評価した結果、原子炉格納容器内の最高圧力が約0.36MPaとなり、また、格納容器過温破損事象においては同流量で評価した結果、原子炉格納容器内の最高温度が約141℃となることから、重大事故対策の有効性評価解析（原子炉設置変更許可申請書添付書類十）において、代替最終ヒートシンクによる格納容器の除熱手段確立までの間、原子炉格納容器内の圧力を原子炉格納容器の最高使用圧力近傍で維持することが可能である<input type="text" value="0.5"/>m<sup>3</sup>/h/個以上とする。</p> <p>公称値については、<input type="text" value="150"/>50m<sup>3</sup>/h/個とする。</p> </div> <div style="border: 1px solid black; padding: 2px; margin-top: 10px; text-align: center;"> <p>枠囲みの内容は機密情報に属しますので公開できません。</p> </div>	

赤字：設備、運用又は体制の相違（設計方針の相違）  
 青字：記載箇所又は記載内容の相違（記載方針の相違）  
 緑字：記載表現、設備名称の相違（実質的な相違なし）

第51条 原子炉格納容器下部の溶融炉心を冷却するための設備

大飯発電所3/4号炉	泊発電所3号炉	相違理由																														
<p style="text-align: center;">大飯発電所3/4号炉</p> <p>なお、1次冷却材圧力0.7MPaについては、有効性評価解析（原子炉設置変更許可申請書添付書類十）において、有効性が確認されている圧力である。</p> <table border="0" style="margin-left: auto; margin-right: auto;"> <tr> <td style="padding-right: 10px;">水源と移送先の圧力差</td> <td style="text-align: center;">□</td> </tr> <tr> <td>静水頭</td> <td style="text-align: center;">□</td> </tr> <tr> <td>機器圧損</td> <td style="text-align: center;">□</td> </tr> <tr> <td>配管及び弁類圧損</td> <td style="text-align: center;">□</td> </tr> <tr> <td style="text-align: center;">合計</td> <td style="text-align: center;">□</td> </tr> </table> <p>以上より、原子炉冷却系統施設のうち非常用炉心冷却設備その他原子炉注水設備として炉心注水時に使用する恒設代替低圧注水ポンプの揚程は□m以上とする。</p> <p>2.2 原子炉格納容器内にスプレイする場合の揚程（□m以上）</p> <p>原子炉格納施設のうち圧力低減設備その他の安全設備又は、原子炉冷却系統施設のうち非常用炉心冷却設備その他原子炉注水設備として格納容器スプレイ時に使用する恒設代替低圧注水ポンプの揚程は、ほう酸水及び淡水を原子炉格納容器内にスプレイする場合の水源と移送先の圧力差、静水頭、機器圧損、配管及び弁類圧損を基に設定する。</p> <table border="0" style="margin-left: auto; margin-right: auto;"> <tr> <td style="padding-right: 10px;">水源と移送先の圧力差</td> <td style="text-align: center;">□</td> </tr> <tr> <td>静水頭</td> <td style="text-align: center;">□</td> </tr> <tr> <td>機器圧損</td> <td style="text-align: center;">□</td> </tr> <tr> <td>配管及び弁類圧損</td> <td style="text-align: center;">□</td> </tr> <tr> <td style="text-align: center;">合計</td> <td style="text-align: center;">□</td> </tr> </table> <p>以上より、原子炉格納施設のうち圧力低減設備その他の安全設備又は、原子炉冷却系統施設のうち非常用炉心冷却設備その他原子炉注水設備として格納容器スプレイ時に使用する恒設代替低圧注水ポンプの揚程は□m以上とする。</p> <p>公称値については、要求される最大揚程□mを上回る150mとする。</p> <p>3. 最高使用圧力（□MPa）</p> <p>恒設代替低圧注水ポンプを重大事故等時において使用する場合の圧力は、ポンプ締切点の揚程1.55MPaおよび静水頭を考慮し、□MPaとする。</p> <p style="text-align: center; border: 1px solid black; padding: 2px;">枠囲みの範囲は機密に係る事項のため公開することはできません。</p>	水源と移送先の圧力差	□	静水頭	□	機器圧損	□	配管及び弁類圧損	□	合計	□	水源と移送先の圧力差	□	静水頭	□	機器圧損	□	配管及び弁類圧損	□	合計	□	<p style="text-align: center;">泊発電所3号炉</p> <p style="text-align: right;">容-5(5/7)</p> <p>2. 揚程</p> <p>2.1 原子炉に注入する場合の揚程 □m以上</p> <p>原子炉冷却系統施設のうち非常用炉心冷却設備その他原子炉注水設備として炉心注水時に使用する代替格納容器スプレイポンプの揚程は、ほう酸水及び淡水を原子炉に注水する場合の水源と移送先の圧力差、静水頭、機器圧損、配管及び弁類圧損を基に設定する。なお、1次冷却材圧力0.7MPaについては、有効性評価解析（原子炉設置変更許可申請書添付書類十）において、有効性が確認されている圧力である。</p> <table border="0" style="margin-left: auto; margin-right: auto;"> <tr> <td style="padding-right: 10px;">水源と移送先の圧力差</td> <td style="text-align: center;">約 72m</td> </tr> <tr> <td>静水頭</td> <td style="text-align: center;">約 -2m</td> </tr> <tr> <td>機器圧損</td> <td style="text-align: center;">約 □m</td> </tr> <tr> <td>配管及び弁類圧損</td> <td style="text-align: center;">約 □m</td> </tr> <tr> <td style="text-align: center;">合計</td> <td style="text-align: center;">約 □m</td> </tr> </table> <p>以上より、原子炉冷却系統施設のうち非常用炉心冷却設備その他原子炉注水設備として使用する代替格納容器スプレイポンプの揚程は、□m以上とする。</p> <p>2.2 原子炉格納容器内にスプレイする場合の揚程 □m以上</p> <p>原子炉格納施設のうち圧力低減設備その他の安全設備又は、原子炉冷却系統施設のうち非常用炉心冷却設備その他原子炉注水設備として格納容器スプレイ時に使用する代替格納容器スプレイポンプの揚程は、大破断LOCA+非常用炉心冷却設備注水失敗+格納容器スプレイ失敗事象などの格納容器過圧破損事象や、全交流動力電源喪失+補助給水機能喪失などの格納容器過温破損事象などにおいて、燃料取替用水ピットから、ほう酸水又は海水を原子炉格納容器内にスプレイする場合の水源と移送先の圧力差、静水頭、機器圧損、配管及び弁類圧損を基に設定する。</p> <p style="text-align: center; border: 1px solid black; padding: 2px;">枠囲みの内容は機密情報に属しますので公開できません。</p>	水源と移送先の圧力差	約 72m	静水頭	約 -2m	機器圧損	約 □m	配管及び弁類圧損	約 □m	合計	約 □m	
水源と移送先の圧力差	□																															
静水頭	□																															
機器圧損	□																															
配管及び弁類圧損	□																															
合計	□																															
水源と移送先の圧力差	□																															
静水頭	□																															
機器圧損	□																															
配管及び弁類圧損	□																															
合計	□																															
水源と移送先の圧力差	約 72m																															
静水頭	約 -2m																															
機器圧損	約 □m																															
配管及び弁類圧損	約 □m																															
合計	約 □m																															

赤字：設備、運用又は体制の相違（設計方針の相違）  
 青字：記載箇所又は記載内容の相違（記載方針の相違）  
 緑字：記載表現、設備名称の相違（実質的な相違なし）

第51条 原子炉格納容器下部の溶融炉心を冷却するための設備

大飯発電所3/4号炉	泊発電所3号炉	相違理由										
<p style="text-align: center;">大飯発電所3/4号炉</p> <div style="border: 1px solid black; padding: 5px; margin: 10px 0;"> <p>4. 最高使用温度 (95℃)                      恒設代替低圧注水ポンプを重大事故等時において使用する場合は、水源である燃料取替用水ピットの使用温度と同じ、95℃とする。</p> <p>5. 原動機出力 <input type="text"/>kW/個)                      恒設代替低圧注水ポンプの原動機出力は、流量150m<sup>3</sup>/h時の軸動力を基に設定する。                      恒設代替低圧注水ポンプの定格容量150m<sup>3</sup>/h、定格揚程150m、そのときの同ポンプの必要軸動力は、以下のとおり <input type="text"/>kWとなる。</p> <div style="border: 2px solid black; width: 150px; height: 150px; margin: 10px auto;"></div> <p style="text-align: center;">(参考文献：「ターボポンプ用語」(JIS B 0131-2002))</p> <p>以上より、恒設代替低圧注水ポンプの原動機出力は、必要軸動力112kwを上回る <input type="text"/>kW/個とする。</p> <div style="border: 1px solid black; padding: 2px; text-align: center; margin-top: 5px;">                         枠囲みの範囲は機密に係る事項のため公開することはできません。                     </div> </div>	<p style="text-align: right;">容-5(6/7)</p> <table style="margin-left: auto; margin-right: auto; border-collapse: collapse;"> <tr> <td style="padding: 2px;">水源と移送先の圧力差</td> <td style="padding: 2px;">約 29m</td> </tr> <tr> <td style="padding: 2px;">静水頭</td> <td style="padding: 2px;">約 28m</td> </tr> <tr> <td style="padding: 2px;">機器圧損</td> <td style="padding: 2px;">約 <input type="text"/>m</td> </tr> <tr> <td style="padding: 2px;">配管及び弁類圧損</td> <td style="padding: 2px;">約 <input type="text"/>m</td> </tr> <tr> <td style="padding: 2px; text-align: center;">合計</td> <td style="padding: 2px;">約 <input type="text"/>m</td> </tr> </table> <p>以上より、原子炉格納施設のうち圧力低減設備その他の安全設備として使用する代替格納容器スプレイポンプの揚程は <input type="text"/>m以上とする。</p> <p>公称値については、定格流量である150m<sup>3</sup>/hの時の揚程である300mとする。</p> <p>3. 最高使用圧力                      代替格納容器スプレイポンプの最高使用圧力は、締切点の揚程から、これを上回る標準的な圧力級を選定する。                      代替格納容器スプレイポンプ締切点の揚程が約380m（＝約3.7MPa）となることから、これを上回る圧力級として、4.1MPaを選定する。                      以上より、代替格納容器スプレイポンプの最高使用圧力は4.1MPaとする。</p> <p>4. 最高使用温度                      代替格納容器スプレイポンプを重大事故等時において使用する場合は、水源である燃料取替用水ピットの使用温度と同じ95℃とする。</p> <p>5. 原動機出力                      代替格納容器スプレイポンプの原動機出力は、定格運転時の軸動力を基に設定する。                      代替格納容器スプレイポンプの定格流量が150m<sup>3</sup>/h、揚程が300m、そのときの同ポンプの必要軸動力は、以下のとおり <input type="text"/>kWとなる。</p> <div style="border: 1px solid black; padding: 2px; text-align: center; margin-top: 10px;"> <input type="text"/> 枠囲みの内容は機密情報に属しますので公開できません。         </div>	水源と移送先の圧力差	約 29m	静水頭	約 28m	機器圧損	約 <input type="text"/> m	配管及び弁類圧損	約 <input type="text"/> m	合計	約 <input type="text"/> m	
水源と移送先の圧力差	約 29m											
静水頭	約 28m											
機器圧損	約 <input type="text"/> m											
配管及び弁類圧損	約 <input type="text"/> m											
合計	約 <input type="text"/> m											



赤字：設備、運用又は体制の相違（設計方針の相違）  
 青字：記載箇所又は記載内容の相違（記載方針の相違）  
 緑字：記載表現、設備名称の相違（実質的な相違なし）

第51条 原子炉格納容器下部の溶融炉心を冷却するための設備

大飯発電所3/4号炉	泊発電所3号炉	相違理由
	<p style="text-align: right;">容-5(7/7)</p> <div style="border: 1px solid black; padding: 10px; margin: 10px auto; width: 80%;"> <math display="block">L = 10^{-3} \times \rho \times g \times \frac{\left(\frac{Q}{3,600}\right) \times H}{\eta}</math> <math display="block">= 10^{-3} \times 1,030 \times 9.80665 \times \frac{\left(\frac{150}{3,600}\right) \times 300}{\square} = \square \text{ W}</math> <p>L：必要軸動力 (kW)                  ρ：流体の密度 (kg/m<sup>3</sup>) = 1,030                  g：重力加速度 (m/s<sup>2</sup>) = 9.80665                  Q：ポンプ流量 (m<sup>3</sup>/h) = 150                  H：ポンプ揚程 (m) = 300                  η：ポンプ効率 = <math>\square</math></p> <p>(参考文献：「ターボポンプ用語」(JIS B 0131-2002))</p> <p>以上より、代替格納容器スプレイポンプの原動機出力は、必要軸動力 <math>\square</math> Wを上回る200kW/個とする。</p> </div> <p style="text-align: center; margin-top: 20px;"><math>\square</math> 枠囲みの内容は機密情報に属しますので公開できません。</p>	

泊発電所3号炉 SA基準適合性 比較表

赤字：設備、運用又は体制の相違（設計方針の相違）  
 青字：記載箇所又は記載内容の相違（記載方針の相違）  
 緑字：記載表現、設備名称の相違（実質的な相違なし）

第51条 原子炉格納容器下部の溶融炉心を冷却するための設備

大飯発電所3/4号炉	泊発電所3号炉	相違理由
<p style="text-align: center;">51-5 系統図</p>	<p style="text-align: center;">51-6 単線結線図</p>	

第51条 原子炉格納容器下部の溶融炉心を冷却するための設備

赤字：設備、運用又は体制の相違（設計方針の相違）  
 青字：記載箇所又は記載内容の相違（記載方針の相違）  
 緑字：記載表現、設備名称の相違（実質的な相違なし）

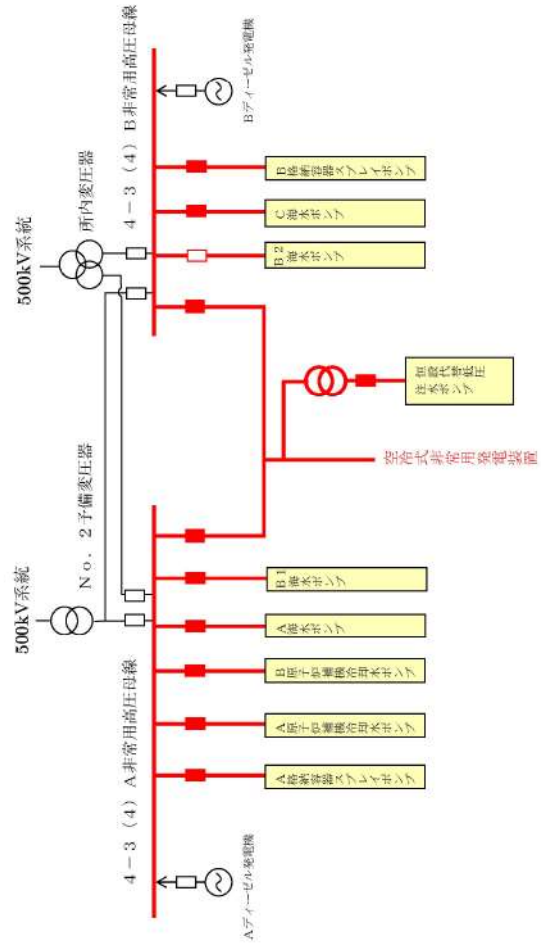
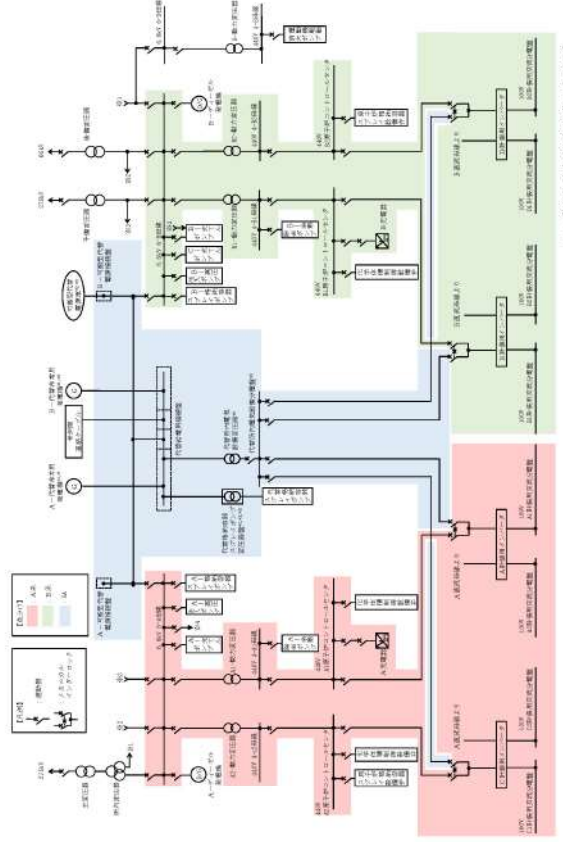
大飯発電所3/4号炉	泊発電所3号炉	相違理由
 <p style="text-align: center;">重大事故等対処設備の電源構成図</p>	 <p style="text-align: center;">図 51-6-1 交流電源接続線図</p>	<p>相違理由</p>
51-5-3	51-6-2	

赤字：設備、運用又は体制の相違（設計方針の相違）  
 青字：記載箇所又は記載内容の相違（記載方針の相違）  
 緑字：記載表現、設備名称の相違（実質的な相違なし）

第51条 原子炉格納容器下部の溶融炉心を冷却するための設備

大飯発電所3/4号炉	泊発電所3号炉	相違理由
<p>51-8 原子炉下部キャビティへの流入について</p>	<p>51-7 原子炉下部キャビティへの流入について</p>	

赤字：設備、運用又は体制の相違（設計方針の相違）  
 青字：記載箇所又は記載内容の相違（記載方針の相違）  
 緑字：記載表現、設備名称の相違（実質的な相違なし）

第51条 原子炉格納容器下部の溶融炉心を冷却するための設備

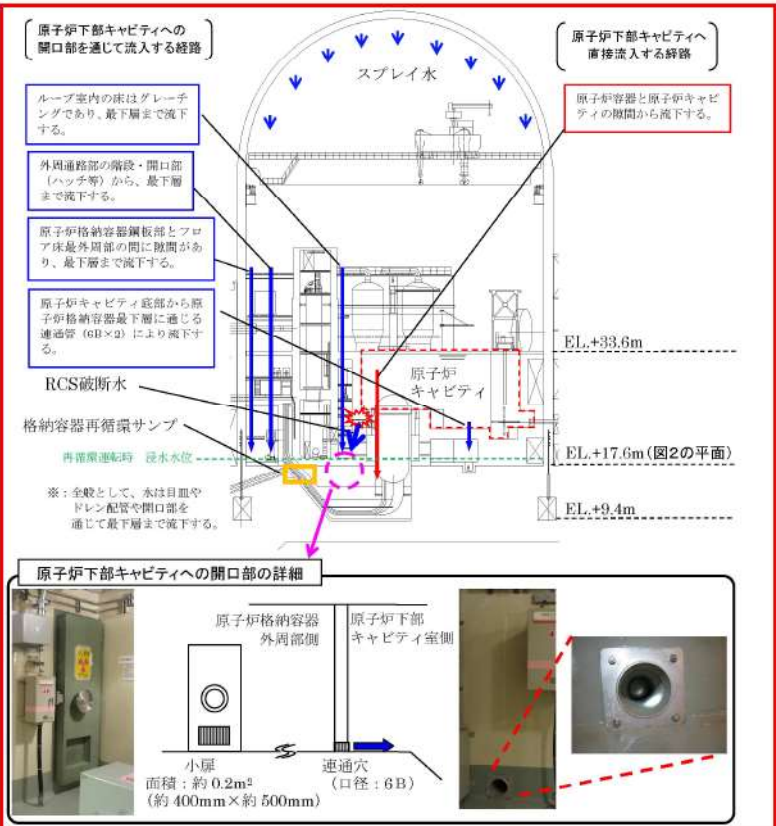
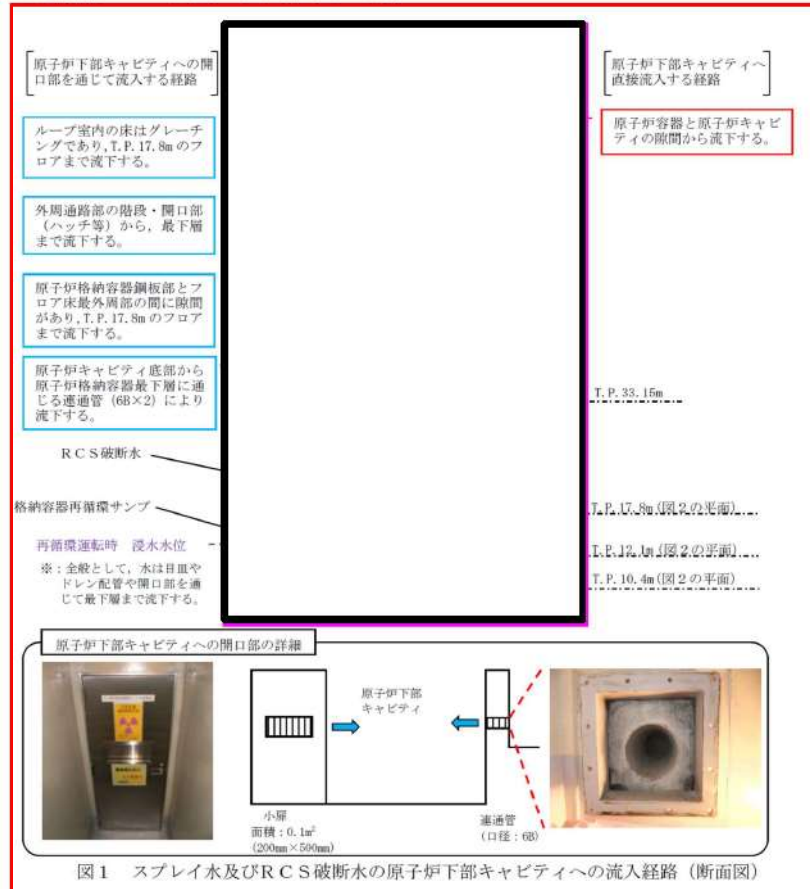
大飯発電所3/4号炉	泊発電所3号炉	相違理由
<p style="text-align: center;">原子炉下部キャビティへの流入経路について</p> <p>LOCA時のRCS破断水および原子炉格納容器に注水されたスプレイ水が原子炉下部キャビティへ流入する経路について、図1および図2に示す。</p>  <p>図1 スプレイ水及びRCS破断水の原子炉下部キャビティへの流入経路（断面図）</p>	<p style="text-align: center;">原子炉下部キャビティへの流入経路について</p> <p>LOCA時のRCS破断水および原子炉格納容器に注水されたスプレイ水が原子炉下部キャビティへ流入する経路について、図1および図2に示す。</p>  <p>図1 スプレイ水及びRCS破断水の原子炉下部キャビティへの流入経路（断面図）</p> <p style="text-align: center;">■ 特記の内容は機密情報に属しますので公開できません。</p>	<p>設計方針の相違</p>

赤字：設備、運用又は体制の相違（設計方針の相違）  
 青字：記載箇所又は記載内容の相違（記載方針の相違）  
 緑字：記載表現、設備名称の相違（実質的な相違なし）

第51条 原子炉格納容器下部の溶融炉心を冷却するための設備

大飯発電所3/4号炉	泊発電所3号炉	相違理由
<p>原子炉下部キャビティ底部から原子炉格納容器最下層に通じる連通管(6B×2)により流下する。</p> <p>原子炉下部キャビティ底部から原子炉格納容器最下層へ流下する。</p> <p>外周通路部の階段・開口部(ハッチ等)から、最下層まで流下している。</p> <p>ループ室内が外周通路部より高いため、外周通路部へ流下する。なお、RCS断水時の場合は、RCS断水後の床面は均一化する方向である等の理由により、どのループが破断しても原子炉下部キャビティへの流入経路・流入速度に有意な差はない。</p> <p>原子炉下部キャビティへ通じる連通管(6B×2)により流下する。</p> <p>原子炉格納容器鋼板部とフロア床最外周部の間に隙間があり、最下層まで流下する。</p> <p>原子炉下部キャビティへの入口扉の小扉から原子炉下部キャビティへ流入する。</p> <p>原子炉格納容器再循環サンプ</p> <p>図2 スプレイ水及びRCS破断水の原子炉下部キャビティへの流入経路(ELL17.6M平面図)</p> <p>水平方向の流れ 鉛直方向の流れ</p> <p>※赤矢印は原子炉下部キャビティへの流下を示す。</p>	<p>ループ室内の床はグレーチングであり、T.P.17.8mのフロアまで流下する。</p> <p>ループ室内が外周通路部より高いため、外周通路部へ流下する。なお、大LOCAの場合、RCS破断水のブローダウンは数十秒で収まり、その後の床面の水位は均一化する方向である等の理由により、どのループが破断しても原子炉下部キャビティへの流入経路、流入速度に有意な差はない。</p> <p>原子炉格納容器鋼板部とフロア床最外周部の間に隙間があり、T.P.17.8mのフロアまで流下する。</p> <p>原子炉下部キャビティ底部から格納容器最下層に通じる連通管(6B×2)により流下する。</p> <p>原子炉下部キャビティへの入口扉の小扉から原子炉下部キャビティへ流入する。</p> <p>格納容器サンプ</p> <p>原子炉下部キャビティへ通じる連通管を経由して原子炉下部キャビティへ流入する。</p> <p>図2 スプレイ水及びRCS破断水の原子炉下部キャビティへの流入経路(T.P.17.8m, T.P.12.1m/10.4m平面図)</p> <p>水平方向の流れ 鉛直方向の流れ</p> <p>※赤矢印は原子炉下部キャビティへの流下を示す。</p> <p>枠囲みの内容は機密情報に属しますので公開できません。</p>	<p>設計方針の相違</p>