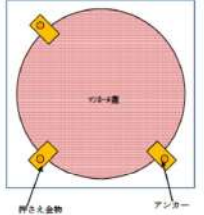

赤字：設備、運用又は体制の相違（設計方針の相違）
 青字：記載箇所又は記載内容の相違（記載方針の相違）
 緑字：記載表現、設備名称の相違（実質的な相違なし）

第6条 外部からの衝撃による損傷の防止（竜巻：別添資料1 添付3.9）

大飯発電所3/4号炉	女川原子力発電所2号炉	泊発電所3号炉	相違理由																																								
<p><余長考慮不可の物品（グレーチング、チェッカープレート、マンホール等）に対する対策事例></p> <p>①対策方法 アンカーと押さえ金物を用いて固定する。</p> <p>②対象設計用荷重（空力係数による浮力） 押さえ金物、アンカーの組数1毎に150kgf以下（グレーチング、チェッカープレート） 押さえ金物、アンカーの組数3毎に500kgf以下（マンホール）</p> <p>③部材 押さえ金物：FB 12×140×80（グレーチング、チェッカープレート） ：FB 12×160×110（マンホール） アンカー：M10</p>  <p>付図2 グレーチングの対策イメージ</p>  <p>付図3 マンホールの対策イメージ</p> <p>④グレーチング、チェッカープレート用アンカーの検討</p> <p>1) 設計条件</p> <table border="0"> <tr> <td>アンカーボルトの規格降伏点強度</td> <td>$\sigma_y = 235$ [N/mm²]</td> <td>SS400</td> </tr> <tr> <td>アンカーボルトの呼び径 M10</td> <td>$d = 10$ [mm]</td> <td></td> </tr> <tr> <td>アンカーボルトの有効断面積</td> <td>$\sigma_{cu} = 68.0$ [mm²]</td> <td></td> </tr> <tr> <td>基礎穿孔径</td> <td>$D = 12.0$ [mm]</td> <td></td> </tr> <tr> <td>基礎穿孔長</td> <td>$L = 90$ [mm]</td> <td></td> </tr> <tr> <td>有効埋込長さ $L_e = L - d$</td> <td>$L_e = 80$ [mm]</td> <td>$(L_e + D/2) = 86.0$ [mm]</td> </tr> <tr> <td>コンクリート圧縮強度</td> <td>$F_c = 21$ [N/mm²]</td> <td></td> </tr> <tr> <td>コンクリートのヤング係数</td> <td>$E_c = 21519$ [N/mm²]</td> <td></td> </tr> </table> <table border="1" data-bbox="313 1093 526 1133"> <tr> <td>許容引張荷重用低減係数</td> <td>短期</td> <td>ϕ_1</td> <td>ϕ_2</td> <td>ϕ_3</td> </tr> <tr> <td>荷重用</td> <td>0.6</td> <td>1.0</td> <td>0.6</td> <td></td> </tr> </table> <table border="1" data-bbox="313 1141 436 1181"> <tr> <td>許容せん断荷重用低減係数</td> <td>短期</td> <td>ϕ</td> </tr> <tr> <td>荷重用</td> <td>1.0</td> <td></td> </tr> </table>	アンカーボルトの規格降伏点強度	$\sigma_y = 235$ [N/mm ²]	SS400	アンカーボルトの呼び径 M10	$d = 10$ [mm]		アンカーボルトの有効断面積	$\sigma_{cu} = 68.0$ [mm ²]		基礎穿孔径	$D = 12.0$ [mm]		基礎穿孔長	$L = 90$ [mm]		有効埋込長さ $L_e = L - d$	$L_e = 80$ [mm]	$(L_e + D/2) = 86.0$ [mm]	コンクリート圧縮強度	$F_c = 21$ [N/mm ²]		コンクリートのヤング係数	$E_c = 21519$ [N/mm ²]		許容引張荷重用低減係数	短期	ϕ_1	ϕ_2	ϕ_3	荷重用	0.6	1.0	0.6		許容せん断荷重用低減係数	短期	ϕ	荷重用	1.0				<p>【大飯】 記載方針の相違 ・泊では、前述の考え方に基づいて飛散防止対策を実施する方針としており、計算例は記載していない。（屋外重大事故等対処設備の固縛装置の強度評価は、設工認で説明する方針。）</p>
アンカーボルトの規格降伏点強度	$\sigma_y = 235$ [N/mm ²]	SS400																																									
アンカーボルトの呼び径 M10	$d = 10$ [mm]																																										
アンカーボルトの有効断面積	$\sigma_{cu} = 68.0$ [mm ²]																																										
基礎穿孔径	$D = 12.0$ [mm]																																										
基礎穿孔長	$L = 90$ [mm]																																										
有効埋込長さ $L_e = L - d$	$L_e = 80$ [mm]	$(L_e + D/2) = 86.0$ [mm]																																									
コンクリート圧縮強度	$F_c = 21$ [N/mm ²]																																										
コンクリートのヤング係数	$E_c = 21519$ [N/mm ²]																																										
許容引張荷重用低減係数	短期	ϕ_1	ϕ_2	ϕ_3																																							
荷重用	0.6	1.0	0.6																																								
許容せん断荷重用低減係数	短期	ϕ																																									
荷重用	1.0																																										

赤字：設備、運用又は体制の相違（設計方針の相違）
 青字：記載箇所又は記載内容の相違（記載方針の相違）
 緑字：記載表現、設備名称の相違（実質的な相違なし）

第6条 外部からの衝撃による損傷の防止（竜巻：別添資料1 添付3.9）

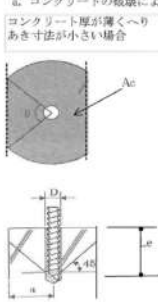
大飯発電所3/4号炉	女川原子力発電所2号炉	泊発電所3号炉	相違理由
<p>2) 短期許容引張荷重</p> <p>a. コンクリートの破壊により決まる短期許容引張荷重</p> <p>コンクリート厚が薄くへりあき寸法が小さい場合</p>  $Pa1 = \phi_1 \times \gamma \times Pa1$ $\gamma : \text{風工係数 (0.75)}$ $Pa1 : \text{最大引張荷重 [N]}$ $Ac : \text{有効水平投影面積 [mm}^2\text{]}$ $Ac = \pi \times Le \times (Le + D) - 2 \times \left[\left(\frac{\theta}{360} \right) \times \pi \times (Le + D/2)^2 \times \sin(\theta/2) \times a \times (Le + D/2) \right]$ $= \pi \times 80 \times (80 + 12) - 2 \times \left[\left(\frac{58.6}{360} \right) \times \pi \times (80 + 12/2)^2 \times \sin(29.3) \times 75 \times (80 + 12/2) \right]$ $= 23122 - 1262$ $= 21870 \text{ [mm}^2\text{]}$ <p>コンクリート厚を150mmとする。</p> $a = 75 \text{ [mm] へりあき寸法}$ $\theta = 2 \cos^{-1} \left(\frac{a}{Le + D/2} \right) = 58.6 \text{ [度]}$ $\sqrt{Fc} \times Ac = \sqrt{21} \times 21870 = 106221$ $\sqrt{Fc} \times Ac \leq 470000 \text{ の場合}$ $Pa1 = 0.39 \times \sqrt{Fc} \times Ac$ $= 0.39 \times \sqrt{21} \times 21870 = 39086 \text{ [N]}$ $Pa1 = \phi_1 \times \gamma \times Pa1$ $= 0.6 \times 0.75 \times 39,086 / 1000 = 17.0 \text{ [kN]}$ <p>b. アンカーボルトの降伏で決まる短期許容引張荷重</p> $Pa2 = \phi_2 \times s \times \sigma_y \times sca$ $= 1.0 \times 235 \times 58 / 1000 = 13.6 \text{ [kN]}$ <p>c. 樹脂硬化物とコンクリートとの界面の付着破壊により決まる短期許容引張荷重</p> $Pa3 = \phi_3 \times \tau \times \pi \times D \times Lo$ $= 0.6 \times 14 \times \pi \times 12 \times 80 / 1000 = 25.3 \text{ [kN]}$ <p>付着強度 $\tau = 14 \times \sqrt{Fc/21}$</p> $= 14 \times \sqrt{21/21} = 14.0 \text{ [N/mm}^2\text{]}$ <p>d. 短期許容引張荷重</p> $Ps = \text{Min}(Pa1, Pa2, Pa3) = 13.6 \text{ [kN]}$ <p>3) 短期許容せん断荷重</p> <p>a. アンカー筋の短期許容せん断荷重</p> $Qa1 = \phi \times 0.7 \times s \times \sigma_y \times sca$ $= 1.0 \times 0.7 \times 235 \times 58 / 1000 = 9.5 \text{ [kN]}$ <p>b. へりあき寸法による短期許容せん断荷重</p> $Ac1 = (1/2) \times \pi \times (a - D/2)^2$ $= (1/2) \times \pi \times (75 - 12/2)^2 \times 2$ $= 7478 \text{ [mm}^2\text{]}$ $Qa2 = \phi \times 0.3 \times \sqrt{Fc} \times Ac1$ $= 0.6 \times 0.31 \times \sqrt{21} \times 7478 / 1000 = 6.3 \text{ [kN]}$ <p>c. 短期許容せん断荷重</p> $Qa = \text{Min}(Qa1, Qa2) = 6.3 \text{ [kN]}$			<p>【大飯】 記載方針の相違 ・泊では、前述の考え方に基づいて飛散防止対策を実施する方針としており、計算例は記載していない。（屋外重大事故等対処設備の固縛装置の強度評価は、設工認で説明する方針。）</p>

赤字：設備、運用又は体制の相違（設計方針の相違）
 青字：記載箇所又は記載内容の相違（記載方針の相違）
 緑字：記載表現、設備名称の相違（実質的な相違なし）

第6条 外部からの衝撃による損傷の防止（竜巻：別添資料1 添付3.9）

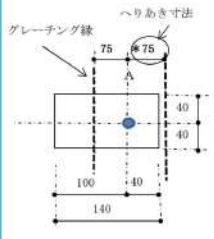
大飯発電所3/4号炉	女川原子力発電所2号炉	泊発電所3号炉	相違理由																														
<p>⑤ グレーチング、チェッカープレート用押さえ金物の検討</p>  <p>アンカーの検討 押さえ金物を固定させるとアンカーに引張とせん断が同時に作用する。 アンカーの短期許容引張荷重は、$P_a = 13.6 \text{ kN}$ また、短期許容せん断荷重は、$Q_a = 6.3 \text{ kN}$</p> <p>引張力およびせん断力が同時に、同じ荷重が作用するとし、ボルトのゆるみを考慮すると、</p> <p>ここで、$P=Q$ とし、上記のボルトにゆるみが発生した場合を考慮してボルトに作用する引張力を $R_a = P + P(100/40) = 3.5P$ とする。</p> <p>組合せによる応力度の検討式（下記）より、</p> $\sqrt{(P/P_a)^2 + (Q/Q_a)^2} < 1.0$ $(3.5P/13.6)^2 + (P/6.3)^2 < 1.0$ $P < 3.30 \text{ (kN)} \quad 337 \text{ (kg)} \rightarrow 300 \text{ (kg)}$ <p>従って、定着（固定）する場合は、押さ上げり力300kg毎に押さえ金物が必要になる。</p> <p>部材の検討 A点における応力の確認 $M = 2.94 \times 100 = 294.2 \text{ [kN}\cdot\text{mm]}$ $Q = 2.94 \text{ [kN]}$</p> <p>PL-140×80×12を使用する。 また、縁部面取りと隅孔部分を考慮し、有効幅を80-12-12=56mmとする。</p> $A = 56 \times 12 = 672 \text{ [mm}^2\text{]}$ $Z = 56 \times 12^2 / 6 = 1344 \text{ [mm}^3\text{]}$ <p>曲げモーメントについて $\sigma_b = M/Z = 219 \text{ kN/mm}^2 < 235 \text{ [kN/mm}^2\text{]}$</p> <p>せん断力について $\tau = 1.5 \times (Q/A) = 7 \text{ kN/mm}^2 < 136 \text{ [kN/mm}^2\text{]}$</p> <p>⑥ マンホール蓋用押さえ金物の検討</p> <p>ケミカルアンカーの許容荷重</p> <table border="1" data-bbox="190 1069 537 1133"> <thead> <tr> <th>ボルト径</th> <th>短期許容引張荷重 (kN/本)</th> <th>短期許容せん断荷重 (kN/本)</th> </tr> </thead> <tbody> <tr> <td>M10</td> <td>13.6</td> <td>9.5</td> </tr> </tbody> </table> <p>押えプレートの許容応力</p> <table border="1" data-bbox="190 1165 537 1212"> <thead> <tr> <th>材質*SS400</th> <th>t ≤ 40mm</th> <th>t > 40mm</th> </tr> </thead> <tbody> <tr> <td>材料強度 F値 (N/mm²)</td> <td>235</td> <td>215</td> </tr> </tbody> </table> <table border="1" data-bbox="190 1220 638 1284"> <thead> <tr> <th rowspan="2">許容応力度 (N/mm²)</th> <th>板厚</th> <th>圧縮 (fc)</th> <th>引張り (ft)</th> <th>曲げ (fb)</th> <th>せん断 (fs)</th> </tr> </thead> <tbody> <tr> <td></td> <td>t ≤ 40mm</td> <td>235</td> <td>235</td> <td>235</td> <td>135</td> </tr> <tr> <td></td> <td>t > 40mm</td> <td>215</td> <td>215</td> <td>215</td> <td>124</td> </tr> </tbody> </table> <p>マンホール押さえ金物は、下記モデルの場合以下の通りとなる。</p>	ボルト径	短期許容引張荷重 (kN/本)	短期許容せん断荷重 (kN/本)	M10	13.6	9.5	材質*SS400	t ≤ 40mm	t > 40mm	材料強度 F値 (N/mm ²)	235	215	許容応力度 (N/mm ²)	板厚	圧縮 (fc)	引張り (ft)	曲げ (fb)	せん断 (fs)		t ≤ 40mm	235	235	235	135		t > 40mm	215	215	215	124			<p>【大飯】 記載方針の相違 ・泊では、前述の考え方に基づいて飛散防止対策を実施する方針としており、計算例は記載していない。（屋外重大事故等対処設備の固縛装置の強度評価は、設工認で説明する方針。）</p>
ボルト径	短期許容引張荷重 (kN/本)	短期許容せん断荷重 (kN/本)																															
M10	13.6	9.5																															
材質*SS400	t ≤ 40mm	t > 40mm																															
材料強度 F値 (N/mm ²)	235	215																															
許容応力度 (N/mm ²)	板厚	圧縮 (fc)	引張り (ft)	曲げ (fb)	せん断 (fs)																												
		t ≤ 40mm	235	235	235	135																											
	t > 40mm	215	215	215	124																												

赤字：設備、運用又は体制の相違（設計方針の相違）
 青字：記載箇所又は記載内容の相違（記載方針の相違）
 緑字：記載表現、設備名称の相違（実質的な相違なし）

第6条 外部からの衝撃による損傷の防止（竜巻：別添資料1 添付3.9）

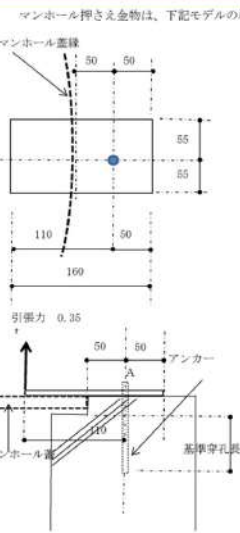
大飯発電所3/4号炉	女川原子力発電所2号炉	泊発電所3号炉	相違理由																																																																
<p>マンホール押さえ金物は、下記モデルの場合以下の通りとなる。</p>  <p>厚さ1上がり力11fを3点で負担として、引張力 $P=3.44\text{ kN}$ (0.35 t) とし、曲げモーメントを 算出すると $M=3.44 \times 110=378.4$ [kN・mm]</p> <p>プレート PL-160×110×12 を使用する。 プレート縁面取り分(12mm)と削孔径(12mm)を除き 有効幅とする。(110-12-12)=86mm</p> <p>$A=86 \times 12=1032$ [N/mm²] $Z=(86 \times 12^2)/6=2064$ [N/mm²]</p> <p>$\sigma_b = M/Z = 378.4 \times 1000/2064=183.3$ [N/mm²] ≤ 235 [N/mm²] ...OK</p> <p>$\tau = (3/2) \times (Q/A)$ $= 1.5 \times (3.44 \times 1000/1032)=5.0$ [N/mm²] ≤ 135 [N/mm²] ...OK</p> <p>引張力 0.35</p> <p>⑦マンホール蓋用アンカーの検討</p> <p>1)</p> <table border="0"> <tr> <td>アンカーボルトの規格降伏点強度</td> <td>$\sigma_{oy} = 235$ [N/mm²]</td> <td>SS400</td> </tr> <tr> <td>アンカーボルトの呼び径 M10</td> <td>$d = 10$ [mm]</td> <td></td> </tr> <tr> <td>アンカーボルトの有効断面積</td> <td>$sca = 58.0$ [mm²]</td> <td></td> </tr> <tr> <td>穿孔径</td> <td>$D = 12$ [mm]</td> <td></td> </tr> <tr> <td>穿孔長</td> <td>$L = 90$ [mm]</td> <td></td> </tr> <tr> <td>有効埋込深さ $Le=L-d$</td> <td>$Le = 80$ [mm]</td> <td></td> </tr> <tr> <td>コンクリート圧縮強度</td> <td>$F_c = 21$ [N/mm²]</td> <td></td> </tr> <tr> <td>コンクリートのヤング係数</td> <td>$E_c = 21519$ [N/mm²]</td> <td></td> </tr> </table> <table border="1" style="margin-top: 10px;"> <tr> <td></td> <td>ϕ_1</td> <td>ϕ_2</td> <td>ϕ_3</td> </tr> <tr> <td>短期荷重用</td> <td>0.6</td> <td>1.0</td> <td>0.6</td> </tr> </table> <table border="1" style="margin-top: 10px;"> <tr> <td></td> <td>ϕ</td> </tr> <tr> <td>許容せん断荷重用</td> <td>1.0</td> </tr> </table> <p>2) 短期許容引張荷重</p> <p>a. コンクリートの破壊により 決まる短期許容引張荷重</p> <table border="0"> <tr> <td>$Pa1 = \phi_1 \times \gamma \times Pu1$</td> <td></td> </tr> <tr> <td>γ : 施工係数 (0.75)</td> <td></td> </tr> <tr> <td>$Pu1$: 最大引張荷重[N]</td> <td></td> </tr> <tr> <td>Ac : 有効水平投影面積[mm²] (1本当たり)</td> <td></td> </tr> <tr> <td>$Ac = \pi \times Le \times (Le + D)$</td> <td></td> </tr> <tr> <td>$= \pi \times 80 \times (80 + 12) =$</td> <td>23122 [mm²]</td> </tr> <tr> <td>$\sqrt{F_c} \times Ac = \sqrt{21} \times 23122 =$</td> <td>105958</td> </tr> <tr> <td>$*\sqrt{F_c} \times Ac \leq 470000$ の場合</td> <td></td> </tr> <tr> <td>$Pu1 = 0.39 \times \sqrt{F_c} \times Ac$</td> <td></td> </tr> <tr> <td>$= 0.39 \times \sqrt{21} \times 23122 =$</td> <td>41324 [N]</td> </tr> <tr> <td>$Pa1 = \phi_1 \times \gamma \times Pu1$</td> <td></td> </tr> <tr> <td>$= 0.6 \times 0.75 \times 41324/1000 =$</td> <td>18.5 [kN]</td> </tr> </table> <p>b. アンカーボルトの降伏で 決まる短期許容引張荷重</p> <table border="0"> <tr> <td>$Pa2 = \phi_2 \times \sigma_{oy} \times sca$</td> <td></td> </tr> <tr> <td>$= 1.0 \times 235 \times 58/1000 =$</td> <td>13.6 [kN]</td> </tr> </table>	アンカーボルトの規格降伏点強度	$\sigma_{oy} = 235$ [N/mm ²]	SS400	アンカーボルトの呼び径 M10	$d = 10$ [mm]		アンカーボルトの有効断面積	$sca = 58.0$ [mm ²]		穿孔径	$D = 12$ [mm]		穿孔長	$L = 90$ [mm]		有効埋込深さ $Le=L-d$	$Le = 80$ [mm]		コンクリート圧縮強度	$F_c = 21$ [N/mm ²]		コンクリートのヤング係数	$E_c = 21519$ [N/mm ²]			ϕ_1	ϕ_2	ϕ_3	短期荷重用	0.6	1.0	0.6		ϕ	許容せん断荷重用	1.0	$Pa1 = \phi_1 \times \gamma \times Pu1$		γ : 施工係数 (0.75)		$Pu1$: 最大引張荷重[N]		Ac : 有効水平投影面積[mm ²] (1本当たり)		$Ac = \pi \times Le \times (Le + D)$		$= \pi \times 80 \times (80 + 12) =$	23122 [mm ²]	$\sqrt{F_c} \times Ac = \sqrt{21} \times 23122 =$	105958	$*\sqrt{F_c} \times Ac \leq 470000$ の場合		$Pu1 = 0.39 \times \sqrt{F_c} \times Ac$		$= 0.39 \times \sqrt{21} \times 23122 =$	41324 [N]	$Pa1 = \phi_1 \times \gamma \times Pu1$		$= 0.6 \times 0.75 \times 41324/1000 =$	18.5 [kN]	$Pa2 = \phi_2 \times \sigma_{oy} \times sca$		$= 1.0 \times 235 \times 58/1000 =$	13.6 [kN]			<p>【大飯】 記載方針の相違 ・泊では、前述の考え方に基づいて飛散防止対策を実施する方針としており、計算例は記載していない。(屋外重大事故等対処設備の固縛装置の強度評価は、設工認で説明する方針。)</p>
アンカーボルトの規格降伏点強度	$\sigma_{oy} = 235$ [N/mm ²]	SS400																																																																	
アンカーボルトの呼び径 M10	$d = 10$ [mm]																																																																		
アンカーボルトの有効断面積	$sca = 58.0$ [mm ²]																																																																		
穿孔径	$D = 12$ [mm]																																																																		
穿孔長	$L = 90$ [mm]																																																																		
有効埋込深さ $Le=L-d$	$Le = 80$ [mm]																																																																		
コンクリート圧縮強度	$F_c = 21$ [N/mm ²]																																																																		
コンクリートのヤング係数	$E_c = 21519$ [N/mm ²]																																																																		
	ϕ_1	ϕ_2	ϕ_3																																																																
短期荷重用	0.6	1.0	0.6																																																																
	ϕ																																																																		
許容せん断荷重用	1.0																																																																		
$Pa1 = \phi_1 \times \gamma \times Pu1$																																																																			
γ : 施工係数 (0.75)																																																																			
$Pu1$: 最大引張荷重[N]																																																																			
Ac : 有効水平投影面積[mm ²] (1本当たり)																																																																			
$Ac = \pi \times Le \times (Le + D)$																																																																			
$= \pi \times 80 \times (80 + 12) =$	23122 [mm ²]																																																																		
$\sqrt{F_c} \times Ac = \sqrt{21} \times 23122 =$	105958																																																																		
$*\sqrt{F_c} \times Ac \leq 470000$ の場合																																																																			
$Pu1 = 0.39 \times \sqrt{F_c} \times Ac$																																																																			
$= 0.39 \times \sqrt{21} \times 23122 =$	41324 [N]																																																																		
$Pa1 = \phi_1 \times \gamma \times Pu1$																																																																			
$= 0.6 \times 0.75 \times 41324/1000 =$	18.5 [kN]																																																																		
$Pa2 = \phi_2 \times \sigma_{oy} \times sca$																																																																			
$= 1.0 \times 235 \times 58/1000 =$	13.6 [kN]																																																																		

赤字：設備、運用又は体制の相違（設計方針の相違）
 青字：記載箇所又は記載内容の相違（記載方針の相違）
 緑字：記載表現、設備名称の相違（実質的な相違なし）

第6条 外部からの衝撃による損傷の防止（竜巻：別添資料1 添付3.9）

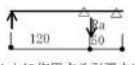
大飯発電所3/4号炉	女川原子力発電所2号炉	泊発電所3号炉	相違理由
<p>3) 短期許容せん断荷重 アンカー筋の短期許容せん断荷重</p> $Q_n = \phi \times 0.7 \times s \sigma_y \times s c a$ $= 1.0 \times 0.7 \times 235 \times 58 / 1000 = 9.5 \text{ [kN]}$ <p>3) アンカーの検討 アンカーには、引張力のみが作用することとする。ただしアンカーボルトのゆるみを考慮して、</p>  $R_a = 3.44 + (3.44 \times 120 / 50) = 11.7 \text{ [kN]}$ <p>アンカーボルトに作用する引張力は、$N = R_a = 11.7 \text{ [kN]}$ アンカーの短期許容引張力が、$P_a = 13.6 \text{ kN}$ であり、 $N = 11.7 \text{ kN} < P_a = 13.6 \text{ kN}$ である。</p>			<p>【大飯】 記載方針の相違 ・泊では、前述の考え方に基づいて飛散防止対策を実施する方針としており、計算例は記載していない。（屋外重大事故等対処設備の固縛装置の強度評価は、設工認で説明する方針。）</p>

赤字：設備、運用又は体制の相違（設計方針の相違）
 青字：記載箇所又は記載内容の相違（記載方針の相違）
 緑字：記載表現、設備名称の相違（実質的な相違なし）

第6条 外部からの衝撃による損傷の防止（竜巻：別添資料1 添付資料3.10）

大飯発電所3/4号炉	女川原子力発電所2号炉	泊発電所3号炉	相違理由
<p>14. 自動車の飛散距離について</p> <p>車両の飛散防止対策については、車両の飛散距離を勘案し、竜巻防護施設から350m以内の車両について飛散防止対策を実施する。</p> <p>その根拠となる飛散距離については、車両の種別（セダン、ワゴン、ミニバン、軽、軽バン、軽トラ）ごとに代表的な車両の寸法、質量を参照し、空力パラメータを算出することによって竜巻風速100m/sによる飛散距離を導出した。以下の表1に各車両の寸法、質量及び空力パラメータ、飛散距離の算出結果を示す。</p> <p>以下より、車両は種別を問わず、設計風速による飛散距離が350m以内となることから350m以内の範囲において飛散防止対策を実施することは妥当であると考える。</p>	<p>【島根原子力発電所2号炉まとめ資料 別添2-1 別紙-7から一部記載】</p> <p style="text-align: right;">別紙-7</p> <p style="text-align: center;">飛來物発生防止対策エリアの設定について</p> <p>飛來物発生防止対策エリアは、ウォークダウン等で確認された飛散した場合の影響が設計飛來物を超える「資機材・車両」及び「軽量大型機材」の飛散解析結果より設定しており、飛散解析は以下の方針に基づきフジタモデルを用いて実施した。</p> <p>【島根原子力発電所2号炉まとめ資料 別添2-1 別紙-7から一部記載】</p> <p>(2) 飛散解析結果及び飛來物発生防止対策エリアの設定</p> <p>表2に、ウォークダウン等で確認された飛來物となり得る物品の形状（棒状、板状、塊状）、寸法、質量、空力パラメータ及び表1に記載している2種類の飛散解析において考慮する敷地の高低差に対する地上からの初期高さを0mとした場合の飛散解析結果（最大飛散距離、最大水平速度、最大飛散高さ等）を示す。</p> <p>表2の結果より、「資機材・車両」及び「軽量大型機材」の飛來物発生防止対策エリアを、「資機材・車両」及び「軽量大型機材」のうち飛散距離が最大となる「乗用車」及び「プレハブ小屋」の飛散距離から、図1、2のとおり設定する。</p>	<p style="text-align: right;">添付資料3.10</p> <p style="text-align: center;">車両管理エリア及び物品管理エリアの設定について</p> <p>車両管理エリア及び物品管理エリアは、ウォークダウンで確認された飛散した場合の影響が設計飛來物を超える「車両」及び「車両以外の物品」の飛散解析結果より設定しており、飛散解析はランキン渦モデルを用いて実施した。</p> <p>表1及び表2に、ウォークダウンで確認された飛散した場合の影響が設計飛來物を超える「車両」及び「車両以外の物品」の種別ごとに代表的な車両等の寸法、質量、空力パラメータ及び飛散距離を示す。</p> <p>表1及び表2の結果より、車両管理エリア及び物品管理エリアを、「車両」及び「車両以外の物品」のうち飛散距離が最大となる「軽乗用車」及び「プレハブ小屋」の飛散距離から、図1のとおり設定する。</p>	<p>【女川】 記載充実（大飯参照）</p> <p>【大飯】 記載表現の相違 【大飯】 記載方針の相違</p> <p>【島根】 対策エリア設定の考え方の相違 ・島根では、プレハブ等の「軽量大型機材」と、それ以外の車両を含めた「資機材・車両」で分類し対策エリアを設定しているが、泊では、女川と同じく、車両と、それ以外の物品で分類し対策エリアを設定しており、考え方は異なるが、2つの対策エリアを設定している島根の記載を参考とした。</p> <p>【島根】 記載表現の相違 【島根】 設計方針の相違 ・泊はランキン渦モデルを適用しており、初期高さを一律40mとして飛散評価しているが、島根はフジタモデルを適用しており、飛散評価に影響する初期高さや設置高さ等の飛散解析条件について、後段で記載している。 ・発電所敷地内の想定飛來物の相違による最大飛散距離車両の相違</p>

泊発電所3号炉 DB基準適合性 比較表

赤字：設備、運用又は体制の相違（設計方針の相違）
 青字：記載箇所又は記載内容の相違（記載方針の相違）
 緑字：記載表現、設備名称の相違（実質的な相違なし）

第6条 外部からの衝撃による損傷の防止（竜巻：別添資料1 添付資料3.10）

大飯発電所3/4号炉	女川原子力発電所2号炉	泊発電所3号炉	相違理由
<p>ただし、今後さらに軽量であり、受風面積の大きい車両が開発されることは否定できないため、発電所において、質量 570kg より軽い車両については、入構させない等の管理を実施することとする。</p>		<p>ただし、今後、さらに軽量であり、受風面積の大きい車両が開発されることは否定できないため、発電所において、質量 720 kg より軽い車両については、事前に飛散評価を行って入構可否を判断する等の管理を実施することとする。</p>	<p>【大飯】 記載表現の相違 【大飯】 設計方針の相違 ・発電所敷地内の車両 質量の相違による軽い 車両の相違</p>

赤字：設備、運用又は体制の相違（設計方針の相違）
 青字：記載箇所又は記載内容の相違（記載方針の相違）
 緑字：記載表現、設備名称の相違（実質的な相違なし）

大飯発電所3/4号炉							女川原子力発電所2号炉							泊発電所3号炉							相違理由																																																																																																																																																																																																																																																																																																																																																																																																																																																																																																																																																																		
<p>表1 車両の種類ごとの飛散距離について</p> <table border="1"> <thead> <tr> <th>飛来物</th> <th>長さ[m]</th> <th>幅[m]</th> <th>高さ[m]</th> <th>質量[kg]</th> <th>空力パラメータ C_DA/m²/kg</th> <th>飛散距離[m]</th> </tr> </thead> <tbody> <tr><td>乗用車（ワゴン1）</td><td>4.48</td><td>1.745</td><td>1.49</td><td>1350</td><td>0.00836</td><td>328</td></tr> <tr><td>乗用車（ワゴン2）</td><td>5.27</td><td>1.89</td><td>1.475</td><td>2070</td><td>0.00654</td><td>308</td></tr> <tr><td>乗用車（ワゴン3）</td><td>4.825</td><td>1.825</td><td>1.47</td><td>1540</td><td>0.00796</td><td>324</td></tr> <tr><td>乗用車（ワゴン4）</td><td>4.36</td><td>1.695</td><td>1.475</td><td>1180</td><td>0.00913</td><td>334</td></tr> <tr><td>乗用車（ワゴン5）</td><td>4.615</td><td>1.775</td><td>1.575</td><td>1470</td><td>0.00820</td><td>326</td></tr> <tr><td>乗用車（ワゴン6）</td><td>4.78</td><td>1.81</td><td>1.48</td><td>1470</td><td>0.00826</td><td>327</td></tr> <tr><td>乗用車（ワゴン7）</td><td>4.64</td><td>1.71</td><td>1.64</td><td>1440</td><td>0.00841</td><td>329</td></tr> <tr><td>乗用車（ワゴン8）</td><td>4.885</td><td>1.84</td><td>1.905</td><td>2110</td><td>0.00682</td><td>313</td></tr> <tr><td>乗用車（ワゴン9）</td><td>4.695</td><td>1.695</td><td>1.98</td><td>1610</td><td>0.00845</td><td>329</td></tr> <tr><td>軽乗用車1</td><td>3.395</td><td>1.475</td><td>1.49</td><td>730</td><td>0.01109</td><td>343</td></tr> <tr><td>軽乗用車2</td><td>3.395</td><td>1.475</td><td>1.62</td><td>810</td><td>0.01051</td><td>341</td></tr> <tr><td>軽乗用車3</td><td>3.395</td><td>1.475</td><td>1.75</td><td>920</td><td>0.00971</td><td>337</td></tr> <tr><td>軽乗用車4</td><td>2.735</td><td>1.475</td><td>1.45</td><td>570</td><td>0.01174</td><td>344</td></tr> <tr><td>軽乗用車（バン）</td><td>3.395</td><td>1.475</td><td>1.875</td><td>970</td><td>0.00962</td><td>337</td></tr> <tr><td>軽乗用車（トラック）</td><td>3.395</td><td>1.475</td><td>1.785</td><td>740</td><td>0.01213</td><td>346</td></tr> <tr><td>軽乗用車（トラック）2</td><td>2.895</td><td>1.335</td><td>1.65</td><td>580</td><td>0.01234</td><td>346</td></tr> </tbody> </table>							飛来物	長さ[m]	幅[m]	高さ[m]	質量[kg]	空力パラメータ C _D A/m ² /kg	飛散距離[m]	乗用車（ワゴン1）	4.48	1.745	1.49	1350	0.00836	328	乗用車（ワゴン2）	5.27	1.89	1.475	2070	0.00654	308	乗用車（ワゴン3）	4.825	1.825	1.47	1540	0.00796	324	乗用車（ワゴン4）	4.36	1.695	1.475	1180	0.00913	334	乗用車（ワゴン5）	4.615	1.775	1.575	1470	0.00820	326	乗用車（ワゴン6）	4.78	1.81	1.48	1470	0.00826	327	乗用車（ワゴン7）	4.64	1.71	1.64	1440	0.00841	329	乗用車（ワゴン8）	4.885	1.84	1.905	2110	0.00682	313	乗用車（ワゴン9）	4.695	1.695	1.98	1610	0.00845	329	軽乗用車1	3.395	1.475	1.49	730	0.01109	343	軽乗用車2	3.395	1.475	1.62	810	0.01051	341	軽乗用車3	3.395	1.475	1.75	920	0.00971	337	軽乗用車4	2.735	1.475	1.45	570	0.01174	344	軽乗用車（バン）	3.395	1.475	1.875	970	0.00962	337	軽乗用車（トラック）	3.395	1.475	1.785	740	0.01213	346	軽乗用車（トラック）2	2.895	1.335	1.65	580	0.01234	346								<p>表1 車両の種類ごとの飛散距離について</p> <table border="1"> <thead> <tr> <th>飛来物</th> <th>長さ[m]</th> <th>幅[m]</th> <th>高さ[m]</th> <th>質量[kg]</th> <th>空力パラメータ C_DA/m²/kg</th> <th>飛散距離[m]</th> </tr> </thead> <tbody> <tr><td>乗用車（セダン1）</td><td>4.89</td><td>1.80</td><td>1.47</td><td>1360</td><td>0.00699</td><td>313</td></tr> <tr><td>乗用車（セダン2）</td><td>4.58</td><td>1.74</td><td>1.46</td><td>1310</td><td>0.00867</td><td>309</td></tr> <tr><td>乗用車（セダン3）</td><td>4.40</td><td>1.69</td><td>1.48</td><td>1170</td><td>0.00924</td><td>335</td></tr> <tr><td>乗用車（ワゴン1）</td><td>4.41</td><td>1.69</td><td>1.50</td><td>1380</td><td>0.00857</td><td>328</td></tr> <tr><td>乗用車（ワゴン2）</td><td>4.40</td><td>1.69</td><td>1.50</td><td>1190</td><td>0.00920</td><td>334</td></tr> <tr><td>乗用車（ワゴン3）</td><td>4.40</td><td>1.69</td><td>1.50</td><td>1200</td><td>0.00912</td><td>333</td></tr> <tr><td>乗用車（ワゴン4）</td><td>4.84</td><td>1.88</td><td>2.10</td><td>2040</td><td>0.00781</td><td>321</td></tr> <tr><td>乗用車（ワゴン5）</td><td>4.84</td><td>1.88</td><td>2.10</td><td>2050</td><td>0.00748</td><td>321</td></tr> <tr><td>乗用車（ワゴン6）</td><td>4.69</td><td>1.69</td><td>2.24</td><td>2350</td><td>0.00624</td><td>304</td></tr> <tr><td>乗用車（ワゴン7）</td><td>5.46</td><td>2.15</td><td>2.57</td><td>2890</td><td>0.00718</td><td>316</td></tr> <tr><td>乗用車（ワゴン8）</td><td>5.49</td><td>1.88</td><td>2.90</td><td>3770</td><td>0.00756</td><td>321</td></tr> <tr><td>乗用車（ワゴン9）</td><td>4.40</td><td>1.69</td><td>1.50</td><td>1180</td><td>0.00927</td><td>335</td></tr> <tr><td>乗用車（バン1）</td><td>4.24</td><td>1.69</td><td>1.53</td><td>1170</td><td>0.00917</td><td>334</td></tr> <tr><td>乗用車（バン2）</td><td>4.69</td><td>1.69</td><td>1.98</td><td>1960</td><td>0.00693</td><td>312</td></tr> <tr><td>乗用車（バン3）</td><td>4.80</td><td>1.69</td><td>2.90</td><td>2770</td><td>0.00642</td><td>307</td></tr> <tr><td>乗用車（バン4）</td><td>4.39</td><td>1.69</td><td>1.54</td><td>1270</td><td>0.00873</td><td>330</td></tr> <tr><td>乗用車（ミニバン1）</td><td>4.68</td><td>1.69</td><td>1.87</td><td>1740</td><td>0.00782</td><td>321</td></tr> <tr><td>乗用車（ミニバン2）</td><td>4.69</td><td>1.69</td><td>1.86</td><td>1660</td><td>0.00787</td><td>324</td></tr> <tr><td>乗用車（ミニバン3）</td><td>4.68</td><td>1.69</td><td>1.87</td><td>2140</td><td>0.00612</td><td>302</td></tr> <tr><td>乗用車（ミニバン4）</td><td>4.69</td><td>1.69</td><td>1.87</td><td>1730</td><td>0.00758</td><td>322</td></tr> <tr><td>乗用車（SUV1）</td><td>3.78</td><td>1.67</td><td>1.70</td><td>1090</td><td>0.01024</td><td>340</td></tr> <tr><td>乗用車（SUV2）</td><td>4.61</td><td>1.79</td><td>1.71</td><td>1500</td><td>0.00845</td><td>327</td></tr> <tr><td>乗用車（SUV3）</td><td>4.56</td><td>1.78</td><td>1.67</td><td>1450</td><td>0.00852</td><td>328</td></tr> <tr><td>乗用車（SUV4）</td><td>4.90</td><td>1.87</td><td>1.67</td><td>2250</td><td>0.00641</td><td>306</td></tr> <tr><td>乗用車（SUV5）</td><td>3.39</td><td>1.47</td><td>1.72</td><td>1040</td><td>0.00847</td><td>327</td></tr> <tr><td>乗用車（SUV6）</td><td>4.64</td><td>1.82</td><td>1.71</td><td>1600</td><td>0.00858</td><td>326</td></tr> <tr><td>乗用車（SUV7）</td><td>4.69</td><td>1.79</td><td>1.69</td><td>1470</td><td>0.00853</td><td>328</td></tr> <tr><td>乗用車（SUV8）</td><td>4.76</td><td>1.88</td><td>1.85</td><td>2080</td><td>0.00674</td><td>310</td></tr> <tr><td>乗用車（SUV9）</td><td>4.90</td><td>1.87</td><td>1.90</td><td>2130</td><td>0.00683</td><td>311</td></tr> <tr><td>乗用車（SUV10）</td><td>4.36</td><td>1.79</td><td>1.56</td><td>1470</td><td>0.00782</td><td>324</td></tr> <tr><td>乗用車（SUV11）</td><td>4.00</td><td>1.69</td><td>1.70</td><td>1200</td><td>0.00904</td><td>333</td></tr> <tr><td>乗用車（SUV12）</td><td>3.99</td><td>1.69</td><td>1.62</td><td>1040</td><td>0.01012</td><td>339</td></tr> <tr><td>軽乗用車1</td><td>3.39</td><td>1.47</td><td>1.51</td><td>720</td><td>0.01130</td><td>344</td></tr> <tr><td>軽乗用車2</td><td>3.39</td><td>1.47</td><td>1.81</td><td>720</td><td>0.01130</td><td>344</td></tr> <tr><td>貨物車1</td><td>20.10</td><td>7.50</td><td>8.25</td><td>58120</td><td>0.00430</td><td>256</td></tr> <tr><td>ポンプ車1</td><td>7.36</td><td>3.39</td><td>3.63</td><td>7950</td><td>0.00409</td><td>240</td></tr> <tr><td>ポンプ車2</td><td>6.93</td><td>2.31</td><td>2.82</td><td>6450</td><td>0.00418</td><td>252</td></tr> <tr><td>ポンプ車3</td><td>7.63</td><td>2.30</td><td>3.05</td><td>10000</td><td>0.00316</td><td>204</td></tr> <tr><td>発電機車2</td><td>11.05</td><td>2.51</td><td>3.31</td><td>24910</td><td>0.00193</td><td>104</td></tr> <tr><td>トラック1</td><td>4.69</td><td>1.69</td><td>1.98</td><td>2750</td><td>0.00494</td><td>277</td></tr> <tr><td>トラック2</td><td>4.67</td><td>1.69</td><td>1.98</td><td>2760</td><td>0.00501</td><td>279</td></tr> <tr><td>トラック3</td><td>6.18</td><td>2.19</td><td>3.02</td><td>3460</td><td>0.00739</td><td>319</td></tr> <tr><td>トラック4</td><td>6.45</td><td>2.31</td><td>3.20</td><td>3750</td><td>0.00493</td><td>277</td></tr> <tr><td>トラック5</td><td>6.90</td><td>2.32</td><td>2.76</td><td>6350</td><td>0.00431</td><td>257</td></tr> <tr><td>トラック6</td><td>11.93</td><td>2.49</td><td>2.66</td><td>8960</td><td>0.00321</td><td>207</td></tr> <tr><td>トラック7</td><td>8.21</td><td>2.46</td><td>2.50</td><td>7410</td><td>0.00418</td><td>252</td></tr> <tr><td>トラック8</td><td>8.21</td><td>2.46</td><td>2.50</td><td>5140</td><td>0.00602</td><td>300</td></tr> <tr><td>トラック9</td><td>8.22</td><td>2.46</td><td>3.08</td><td>5180</td><td>0.00677</td><td>310</td></tr> <tr><td>トラック10</td><td>8.22</td><td>2.46</td><td>3.08</td><td>5180</td><td>0.00677</td><td>310</td></tr> <tr><td>トラック11</td><td>8.22</td><td>2.46</td><td>2.56</td><td>5040</td><td>0.00622</td><td>304</td></tr> <tr><td>トラック12</td><td>8.18</td><td>2.46</td><td>2.56</td><td>3880</td><td>0.00806</td><td>325</td></tr> <tr><td>トラック13</td><td>8.21</td><td>2.47</td><td>2.49</td><td>4870</td><td>0.00636</td><td>306</td></tr> <tr><td>トラック14</td><td>11.98</td><td>2.49</td><td>3.41</td><td>11730</td><td>0.00446</td><td>262</td></tr> <tr><td>トラック15</td><td>8.17</td><td>2.37</td><td>2.94</td><td>5120</td><td>0.00659</td><td>307</td></tr> <tr><td>バス（中型）</td><td>8.99</td><td>2.34</td><td>3.03</td><td>7410</td><td>0.00494</td><td>277</td></tr> <tr><td>バス（大型）</td><td>11.13</td><td>2.48</td><td>3.07</td><td>9490</td><td>0.00464</td><td>269</td></tr> <tr><td>ポンプ車4</td><td>11.92</td><td>2.49</td><td>3.47</td><td>22990</td><td>0.00233</td><td>142</td></tr> <tr><td>ポンプ車5</td><td>11.99</td><td>2.49</td><td>3.58</td><td>24750</td><td>0.00218</td><td>129</td></tr> <tr><td>ポンプ車6</td><td>8.79</td><td>2.49</td><td>3.16</td><td>13050</td><td>0.00291</td><td>190</td></tr> <tr><td>トラック16</td><td>9.91</td><td>2.49</td><td>3.03</td><td>9700</td><td>0.00475</td><td>272</td></tr> </tbody> </table>							飛来物	長さ[m]	幅[m]	高さ[m]	質量[kg]	空力パラメータ C _D A/m ² /kg	飛散距離[m]	乗用車（セダン1）	4.89	1.80	1.47	1360	0.00699	313	乗用車（セダン2）	4.58	1.74	1.46	1310	0.00867	309	乗用車（セダン3）	4.40	1.69	1.48	1170	0.00924	335	乗用車（ワゴン1）	4.41	1.69	1.50	1380	0.00857	328	乗用車（ワゴン2）	4.40	1.69	1.50	1190	0.00920	334	乗用車（ワゴン3）	4.40	1.69	1.50	1200	0.00912	333	乗用車（ワゴン4）	4.84	1.88	2.10	2040	0.00781	321	乗用車（ワゴン5）	4.84	1.88	2.10	2050	0.00748	321	乗用車（ワゴン6）	4.69	1.69	2.24	2350	0.00624	304	乗用車（ワゴン7）	5.46	2.15	2.57	2890	0.00718	316	乗用車（ワゴン8）	5.49	1.88	2.90	3770	0.00756	321	乗用車（ワゴン9）	4.40	1.69	1.50	1180	0.00927	335	乗用車（バン1）	4.24	1.69	1.53	1170	0.00917	334	乗用車（バン2）	4.69	1.69	1.98	1960	0.00693	312	乗用車（バン3）	4.80	1.69	2.90	2770	0.00642	307	乗用車（バン4）	4.39	1.69	1.54	1270	0.00873	330	乗用車（ミニバン1）	4.68	1.69	1.87	1740	0.00782	321	乗用車（ミニバン2）	4.69	1.69	1.86	1660	0.00787	324	乗用車（ミニバン3）	4.68	1.69	1.87	2140	0.00612	302	乗用車（ミニバン4）	4.69	1.69	1.87	1730	0.00758	322	乗用車（SUV1）	3.78	1.67	1.70	1090	0.01024	340	乗用車（SUV2）	4.61	1.79	1.71	1500	0.00845	327	乗用車（SUV3）	4.56	1.78	1.67	1450	0.00852	328	乗用車（SUV4）	4.90	1.87	1.67	2250	0.00641	306	乗用車（SUV5）	3.39	1.47	1.72	1040	0.00847	327	乗用車（SUV6）	4.64	1.82	1.71	1600	0.00858	326	乗用車（SUV7）	4.69	1.79	1.69	1470	0.00853	328	乗用車（SUV8）	4.76	1.88	1.85	2080	0.00674	310	乗用車（SUV9）	4.90	1.87	1.90	2130	0.00683	311	乗用車（SUV10）	4.36	1.79	1.56	1470	0.00782	324	乗用車（SUV11）	4.00	1.69	1.70	1200	0.00904	333	乗用車（SUV12）	3.99	1.69	1.62	1040	0.01012	339	軽乗用車1	3.39	1.47	1.51	720	0.01130	344	軽乗用車2	3.39	1.47	1.81	720	0.01130	344	貨物車1	20.10	7.50	8.25	58120	0.00430	256	ポンプ車1	7.36	3.39	3.63	7950	0.00409	240	ポンプ車2	6.93	2.31	2.82	6450	0.00418	252	ポンプ車3	7.63	2.30	3.05	10000	0.00316	204	発電機車2	11.05	2.51	3.31	24910	0.00193	104	トラック1	4.69	1.69	1.98	2750	0.00494	277	トラック2	4.67	1.69	1.98	2760	0.00501	279	トラック3	6.18	2.19	3.02	3460	0.00739	319	トラック4	6.45	2.31	3.20	3750	0.00493	277	トラック5	6.90	2.32	2.76	6350	0.00431	257	トラック6	11.93	2.49	2.66	8960	0.00321	207	トラック7	8.21	2.46	2.50	7410	0.00418	252	トラック8	8.21	2.46	2.50	5140	0.00602	300	トラック9	8.22	2.46	3.08	5180	0.00677	310	トラック10	8.22	2.46	3.08	5180	0.00677	310	トラック11	8.22	2.46	2.56	5040	0.00622	304	トラック12	8.18	2.46	2.56	3880	0.00806	325	トラック13	8.21	2.47	2.49	4870	0.00636	306	トラック14	11.98	2.49	3.41	11730	0.00446	262	トラック15	8.17	2.37	2.94	5120	0.00659	307	バス（中型）	8.99	2.34	3.03	7410	0.00494	277	バス（大型）	11.13	2.48	3.07	9490	0.00464	269	ポンプ車4	11.92	2.49	3.47	22990	0.00233	142	ポンプ車5	11.99	2.49	3.58	24750	0.00218	129	ポンプ車6	8.79	2.49	3.16	13050	0.00291	190	トラック16	9.91	2.49	3.03	9700	0.00475	272	<p>【大飯】 設計方針の相違 ・泊では、車両以外の物品に対して飛散防止対策を実施する範囲を定めており、代表的な物品の飛散評価結果を記載している。</p>
飛来物	長さ[m]	幅[m]	高さ[m]	質量[kg]	空力パラメータ C _D A/m ² /kg	飛散距離[m]																																																																																																																																																																																																																																																																																																																																																																																																																																																																																																																																																																																	
乗用車（ワゴン1）	4.48	1.745	1.49	1350	0.00836	328																																																																																																																																																																																																																																																																																																																																																																																																																																																																																																																																																																																	
乗用車（ワゴン2）	5.27	1.89	1.475	2070	0.00654	308																																																																																																																																																																																																																																																																																																																																																																																																																																																																																																																																																																																	
乗用車（ワゴン3）	4.825	1.825	1.47	1540	0.00796	324																																																																																																																																																																																																																																																																																																																																																																																																																																																																																																																																																																																	
乗用車（ワゴン4）	4.36	1.695	1.475	1180	0.00913	334																																																																																																																																																																																																																																																																																																																																																																																																																																																																																																																																																																																	
乗用車（ワゴン5）	4.615	1.775	1.575	1470	0.00820	326																																																																																																																																																																																																																																																																																																																																																																																																																																																																																																																																																																																	
乗用車（ワゴン6）	4.78	1.81	1.48	1470	0.00826	327																																																																																																																																																																																																																																																																																																																																																																																																																																																																																																																																																																																	
乗用車（ワゴン7）	4.64	1.71	1.64	1440	0.00841	329																																																																																																																																																																																																																																																																																																																																																																																																																																																																																																																																																																																	
乗用車（ワゴン8）	4.885	1.84	1.905	2110	0.00682	313																																																																																																																																																																																																																																																																																																																																																																																																																																																																																																																																																																																	
乗用車（ワゴン9）	4.695	1.695	1.98	1610	0.00845	329																																																																																																																																																																																																																																																																																																																																																																																																																																																																																																																																																																																	
軽乗用車1	3.395	1.475	1.49	730	0.01109	343																																																																																																																																																																																																																																																																																																																																																																																																																																																																																																																																																																																	
軽乗用車2	3.395	1.475	1.62	810	0.01051	341																																																																																																																																																																																																																																																																																																																																																																																																																																																																																																																																																																																	
軽乗用車3	3.395	1.475	1.75	920	0.00971	337																																																																																																																																																																																																																																																																																																																																																																																																																																																																																																																																																																																	
軽乗用車4	2.735	1.475	1.45	570	0.01174	344																																																																																																																																																																																																																																																																																																																																																																																																																																																																																																																																																																																	
軽乗用車（バン）	3.395	1.475	1.875	970	0.00962	337																																																																																																																																																																																																																																																																																																																																																																																																																																																																																																																																																																																	
軽乗用車（トラック）	3.395	1.475	1.785	740	0.01213	346																																																																																																																																																																																																																																																																																																																																																																																																																																																																																																																																																																																	
軽乗用車（トラック）2	2.895	1.335	1.65	580	0.01234	346																																																																																																																																																																																																																																																																																																																																																																																																																																																																																																																																																																																	
飛来物	長さ[m]	幅[m]	高さ[m]	質量[kg]	空力パラメータ C _D A/m ² /kg	飛散距離[m]																																																																																																																																																																																																																																																																																																																																																																																																																																																																																																																																																																																	
乗用車（セダン1）	4.89	1.80	1.47	1360	0.00699	313																																																																																																																																																																																																																																																																																																																																																																																																																																																																																																																																																																																	
乗用車（セダン2）	4.58	1.74	1.46	1310	0.00867	309																																																																																																																																																																																																																																																																																																																																																																																																																																																																																																																																																																																	
乗用車（セダン3）	4.40	1.69	1.48	1170	0.00924	335																																																																																																																																																																																																																																																																																																																																																																																																																																																																																																																																																																																	
乗用車（ワゴン1）	4.41	1.69	1.50	1380	0.00857	328																																																																																																																																																																																																																																																																																																																																																																																																																																																																																																																																																																																	
乗用車（ワゴン2）	4.40	1.69	1.50	1190	0.00920	334																																																																																																																																																																																																																																																																																																																																																																																																																																																																																																																																																																																	
乗用車（ワゴン3）	4.40	1.69	1.50	1200	0.00912	333																																																																																																																																																																																																																																																																																																																																																																																																																																																																																																																																																																																	
乗用車（ワゴン4）	4.84	1.88	2.10	2040	0.00781	321																																																																																																																																																																																																																																																																																																																																																																																																																																																																																																																																																																																	
乗用車（ワゴン5）	4.84	1.88	2.10	2050	0.00748	321																																																																																																																																																																																																																																																																																																																																																																																																																																																																																																																																																																																	
乗用車（ワゴン6）	4.69	1.69	2.24	2350	0.00624	304																																																																																																																																																																																																																																																																																																																																																																																																																																																																																																																																																																																	
乗用車（ワゴン7）	5.46	2.15	2.57	2890	0.00718	316																																																																																																																																																																																																																																																																																																																																																																																																																																																																																																																																																																																	
乗用車（ワゴン8）	5.49	1.88	2.90	3770	0.00756	321																																																																																																																																																																																																																																																																																																																																																																																																																																																																																																																																																																																	
乗用車（ワゴン9）	4.40	1.69	1.50	1180	0.00927	335																																																																																																																																																																																																																																																																																																																																																																																																																																																																																																																																																																																	
乗用車（バン1）	4.24	1.69	1.53	1170	0.00917	334																																																																																																																																																																																																																																																																																																																																																																																																																																																																																																																																																																																	
乗用車（バン2）	4.69	1.69	1.98	1960	0.00693	312																																																																																																																																																																																																																																																																																																																																																																																																																																																																																																																																																																																	
乗用車（バン3）	4.80	1.69	2.90	2770	0.00642	307																																																																																																																																																																																																																																																																																																																																																																																																																																																																																																																																																																																	
乗用車（バン4）	4.39	1.69	1.54	1270	0.00873	330																																																																																																																																																																																																																																																																																																																																																																																																																																																																																																																																																																																	
乗用車（ミニバン1）	4.68	1.69	1.87	1740	0.00782	321																																																																																																																																																																																																																																																																																																																																																																																																																																																																																																																																																																																	
乗用車（ミニバン2）	4.69	1.69	1.86	1660	0.00787	324																																																																																																																																																																																																																																																																																																																																																																																																																																																																																																																																																																																	
乗用車（ミニバン3）	4.68	1.69	1.87	2140	0.00612	302																																																																																																																																																																																																																																																																																																																																																																																																																																																																																																																																																																																	
乗用車（ミニバン4）	4.69	1.69	1.87	1730	0.00758	322																																																																																																																																																																																																																																																																																																																																																																																																																																																																																																																																																																																	
乗用車（SUV1）	3.78	1.67	1.70	1090	0.01024	340																																																																																																																																																																																																																																																																																																																																																																																																																																																																																																																																																																																	
乗用車（SUV2）	4.61	1.79	1.71	1500	0.00845	327																																																																																																																																																																																																																																																																																																																																																																																																																																																																																																																																																																																	
乗用車（SUV3）	4.56	1.78	1.67	1450	0.00852	328																																																																																																																																																																																																																																																																																																																																																																																																																																																																																																																																																																																	
乗用車（SUV4）	4.90	1.87	1.67	2250	0.00641	306																																																																																																																																																																																																																																																																																																																																																																																																																																																																																																																																																																																	
乗用車（SUV5）	3.39	1.47	1.72	1040	0.00847	327																																																																																																																																																																																																																																																																																																																																																																																																																																																																																																																																																																																	
乗用車（SUV6）	4.64	1.82	1.71	1600	0.00858	326																																																																																																																																																																																																																																																																																																																																																																																																																																																																																																																																																																																	
乗用車（SUV7）	4.69	1.79	1.69	1470	0.00853	328																																																																																																																																																																																																																																																																																																																																																																																																																																																																																																																																																																																	
乗用車（SUV8）	4.76	1.88	1.85	2080	0.00674	310																																																																																																																																																																																																																																																																																																																																																																																																																																																																																																																																																																																	
乗用車（SUV9）	4.90	1.87	1.90	2130	0.00683	311																																																																																																																																																																																																																																																																																																																																																																																																																																																																																																																																																																																	
乗用車（SUV10）	4.36	1.79	1.56	1470	0.00782	324																																																																																																																																																																																																																																																																																																																																																																																																																																																																																																																																																																																	
乗用車（SUV11）	4.00	1.69	1.70	1200	0.00904	333																																																																																																																																																																																																																																																																																																																																																																																																																																																																																																																																																																																	
乗用車（SUV12）	3.99	1.69	1.62	1040	0.01012	339																																																																																																																																																																																																																																																																																																																																																																																																																																																																																																																																																																																	
軽乗用車1	3.39	1.47	1.51	720	0.01130	344																																																																																																																																																																																																																																																																																																																																																																																																																																																																																																																																																																																	
軽乗用車2	3.39	1.47	1.81	720	0.01130	344																																																																																																																																																																																																																																																																																																																																																																																																																																																																																																																																																																																	
貨物車1	20.10	7.50	8.25	58120	0.00430	256																																																																																																																																																																																																																																																																																																																																																																																																																																																																																																																																																																																	
ポンプ車1	7.36	3.39	3.63	7950	0.00409	240																																																																																																																																																																																																																																																																																																																																																																																																																																																																																																																																																																																	
ポンプ車2	6.93	2.31	2.82	6450	0.00418	252																																																																																																																																																																																																																																																																																																																																																																																																																																																																																																																																																																																	
ポンプ車3	7.63	2.30	3.05	10000	0.00316	204																																																																																																																																																																																																																																																																																																																																																																																																																																																																																																																																																																																	
発電機車2	11.05	2.51	3.31	24910	0.00193	104																																																																																																																																																																																																																																																																																																																																																																																																																																																																																																																																																																																	
トラック1	4.69	1.69	1.98	2750	0.00494	277																																																																																																																																																																																																																																																																																																																																																																																																																																																																																																																																																																																	
トラック2	4.67	1.69	1.98	2760	0.00501	279																																																																																																																																																																																																																																																																																																																																																																																																																																																																																																																																																																																	
トラック3	6.18	2.19	3.02	3460	0.00739	319																																																																																																																																																																																																																																																																																																																																																																																																																																																																																																																																																																																	
トラック4	6.45	2.31	3.20	3750	0.00493	277																																																																																																																																																																																																																																																																																																																																																																																																																																																																																																																																																																																	
トラック5	6.90	2.32	2.76	6350	0.00431	257																																																																																																																																																																																																																																																																																																																																																																																																																																																																																																																																																																																	
トラック6	11.93	2.49	2.66	8960	0.00321	207																																																																																																																																																																																																																																																																																																																																																																																																																																																																																																																																																																																	
トラック7	8.21	2.46	2.50	7410	0.00418	252																																																																																																																																																																																																																																																																																																																																																																																																																																																																																																																																																																																	
トラック8	8.21	2.46	2.50	5140	0.00602	300																																																																																																																																																																																																																																																																																																																																																																																																																																																																																																																																																																																	
トラック9	8.22	2.46	3.08	5180	0.00677	310																																																																																																																																																																																																																																																																																																																																																																																																																																																																																																																																																																																	
トラック10	8.22	2.46	3.08	5180	0.00677	310																																																																																																																																																																																																																																																																																																																																																																																																																																																																																																																																																																																	
トラック11	8.22	2.46	2.56	5040	0.00622	304																																																																																																																																																																																																																																																																																																																																																																																																																																																																																																																																																																																	
トラック12	8.18	2.46	2.56	3880	0.00806	325																																																																																																																																																																																																																																																																																																																																																																																																																																																																																																																																																																																	
トラック13	8.21	2.47	2.49	4870	0.00636	306																																																																																																																																																																																																																																																																																																																																																																																																																																																																																																																																																																																	
トラック14	11.98	2.49	3.41	11730	0.00446	262																																																																																																																																																																																																																																																																																																																																																																																																																																																																																																																																																																																	
トラック15	8.17	2.37	2.94	5120	0.00659	307																																																																																																																																																																																																																																																																																																																																																																																																																																																																																																																																																																																	
バス（中型）	8.99	2.34	3.03	7410	0.00494	277																																																																																																																																																																																																																																																																																																																																																																																																																																																																																																																																																																																	
バス（大型）	11.13	2.48	3.07	9490	0.00464	269																																																																																																																																																																																																																																																																																																																																																																																																																																																																																																																																																																																	
ポンプ車4	11.92	2.49	3.47	22990	0.00233	142																																																																																																																																																																																																																																																																																																																																																																																																																																																																																																																																																																																	
ポンプ車5	11.99	2.49	3.58	24750	0.00218	129																																																																																																																																																																																																																																																																																																																																																																																																																																																																																																																																																																																	
ポンプ車6	8.79	2.49	3.16	13050	0.00291	190																																																																																																																																																																																																																																																																																																																																																																																																																																																																																																																																																																																	
トラック16	9.91	2.49	3.03	9700	0.00475	272																																																																																																																																																																																																																																																																																																																																																																																																																																																																																																																																																																																	
							<table border="1"> <thead> <tr> <th>飛来物</th> <th>長さ[m]</th> <th>幅[m]</th> <th>高さ[m]</th> <th>質量[kg]</th> <th>空力パラメータ C_DA/m²/kg</th> <th>飛散距離[m]</th> </tr> </thead> <tbody> <tr><td>トラック17</td><td>8.44</td><td>2.49</td><td>3.32</td><td>10620</td><td>0.00357</td><td>227</td></tr> <tr><td>トラック18</td><td>8.38</td><td>2.49</td><td>3.36</td><td>10680</td><td>0.00355</td><td>226</td></tr> <tr><td>タンクローリー</td><td>6.28</td><td>2.20</td><td>2.41</td><td>4380</td><td>0.00517</td><td>282</td></tr> <tr><td>重機1</td><td>9.53</td><td>3.15</td><td>3.10</td><td>20800</td><td>0.00223</td><td>134</td></tr> <tr><td>重機2</td><td>7.13</td><td>3.05</td><td>3.37</td><td>10140</td><td>0.00365</td><td>231</td></tr> <tr><td>重機3</td><td>6.50</td><td>3.26</td><td>3.17</td><td>26600</td><td>0.00130</td><td>56</td></tr> <tr><td>発電機車3</td><td>16.61</td><td>2.98</td><td>4.99</td><td>48215</td><td>0.00202</td><td>112</td></tr> </tbody> </table>							飛来物	長さ[m]	幅[m]	高さ[m]	質量[kg]	空力パラメータ C _D A/m ² /kg	飛散距離[m]	トラック17	8.44	2.49	3.32	10620	0.00357	227	トラック18	8.38	2.49	3.36	10680	0.00355	226	タンクローリー	6.28	2.20	2.41	4380	0.00517	282	重機1	9.53	3.15	3.10	20800	0.00223	134	重機2	7.13	3.05	3.37	10140	0.00365	231	重機3	6.50	3.26	3.17	26600	0.00130	56	発電機車3	16.61	2.98	4.99	48215	0.00202	112																																																																																																																																																																																																																																																																																																																																																																																																																																																																																																																		
飛来物	長さ[m]	幅[m]	高さ[m]	質量[kg]	空力パラメータ C _D A/m ² /kg	飛散距離[m]																																																																																																																																																																																																																																																																																																																																																																																																																																																																																																																																																																																	
トラック17	8.44	2.49	3.32	10620	0.00357	227																																																																																																																																																																																																																																																																																																																																																																																																																																																																																																																																																																																	
トラック18	8.38	2.49	3.36	10680	0.00355	226																																																																																																																																																																																																																																																																																																																																																																																																																																																																																																																																																																																	
タンクローリー	6.28	2.20	2.41	4380	0.00517	282																																																																																																																																																																																																																																																																																																																																																																																																																																																																																																																																																																																	
重機1	9.53	3.15	3.10	20800	0.00223	134																																																																																																																																																																																																																																																																																																																																																																																																																																																																																																																																																																																	
重機2	7.13	3.05	3.37	10140	0.00365	231																																																																																																																																																																																																																																																																																																																																																																																																																																																																																																																																																																																	
重機3	6.50	3.26	3.17	26600	0.00130	56																																																																																																																																																																																																																																																																																																																																																																																																																																																																																																																																																																																	
発電機車3	16.61	2.98	4.99	48215	0.00202	112																																																																																																																																																																																																																																																																																																																																																																																																																																																																																																																																																																																	

赤字：設備、運用又は体制の相違（設計方針の相違）
 青字：記載箇所又は記載内容の相違（記載方針の相違）
 緑字：記載表現、設備名称の相違（実質的な相違なし）

大飯発電所3/4号炉	女川原子力発電所2号炉	泊発電所3号炉	相違理由																																																																																																																																																																																																																																																																																																																																																																																																																																																																																																																																						
		<p>表2 車両以外の物品の種別ごとの飛散距離について</p> <table border="1"> <thead> <tr> <th>飛来物</th> <th>長さ[m]</th> <th>幅[m]</th> <th>高さ[m]</th> <th>質量[kg]</th> <th>密度パラメータ C₀A/m²/kg</th> <th>飛散距離[m]</th> </tr> </thead> <tbody> <tr><td>発電機1</td><td>0.80</td><td>1.87</td><td>1.05</td><td>1440</td><td>0.00172</td><td>85</td></tr> <tr><td>発電機2</td><td>0.95</td><td>2.09</td><td>1.30</td><td>4290</td><td>0.00092</td><td>24</td></tr> <tr><td>発電機3</td><td>1.40</td><td>3.90</td><td>1.76</td><td>5040</td><td>0.00194</td><td>105</td></tr> <tr><td>発電機4</td><td>0.98</td><td>2.09</td><td>1.55</td><td>1690</td><td>0.00266</td><td>172</td></tr> <tr><td>タンク</td><td>3.08</td><td>9.20</td><td>3.45</td><td>95805</td><td>0.00049</td><td>15</td></tr> <tr><td>発電機5</td><td>0.98</td><td>2.09</td><td>1.55</td><td>1690</td><td>0.00266</td><td>172</td></tr> <tr><td>網板1</td><td>1.53</td><td>3.06</td><td>0.022</td><td>911</td><td>0.00344</td><td>221</td></tr> <tr><td>プレハブ小屋1</td><td>4.50</td><td>3.50</td><td>2.30</td><td>1735</td><td>0.01380</td><td>354</td></tr> <tr><td>発電機6</td><td>0.95</td><td>2.09</td><td>1.55</td><td>1690</td><td>0.00266</td><td>172</td></tr> <tr><td>発電機7</td><td>1.18</td><td>2.45</td><td>1.83</td><td>2150</td><td>0.00229</td><td>139</td></tr> <tr><td>発電機8</td><td>0.70</td><td>1.55</td><td>1.24</td><td>820</td><td>0.00312</td><td>202</td></tr> <tr><td>発電機9</td><td>0.98</td><td>2.09</td><td>1.55</td><td>1690</td><td>0.00266</td><td>172</td></tr> <tr><td>ケーブルドラム1</td><td>2.40</td><td>2.40</td><td>1.17</td><td>3050</td><td>0.00247</td><td>154</td></tr> <tr><td>発電機10</td><td>0.98</td><td>2.09</td><td>1.55</td><td>1690</td><td>0.00266</td><td>172</td></tr> <tr><td>プレハブ小屋2</td><td>1.92</td><td>1.85</td><td>2.64</td><td>500</td><td>0.01783</td><td>395</td></tr> <tr><td>網板2</td><td>6.11</td><td>1.53</td><td>0.02</td><td>1480</td><td>0.00421</td><td>253</td></tr> <tr><td>発電機11</td><td>0.98</td><td>2.09</td><td>1.55</td><td>1690</td><td>0.00266</td><td>172</td></tr> <tr><td>カードル</td><td>1.01</td><td>1.39</td><td>1.41</td><td>1500</td><td>0.00211</td><td>122</td></tr> <tr><td>発電機12</td><td>1.74</td><td>0.88</td><td>1.35</td><td>1170</td><td>0.00286</td><td>186</td></tr> <tr><td>発電機13</td><td>0.65</td><td>1.48</td><td>1.11</td><td>670</td><td>0.00528</td><td>211</td></tr> <tr><td>プレハブ小屋3</td><td>1.94</td><td>1.94</td><td>2.16</td><td>490</td><td>0.01336</td><td>301</td></tr> <tr><td>ケーブルドラム2</td><td>2.01</td><td>2.01</td><td>1.00</td><td>1330</td><td>0.00490</td><td>245</td></tr> <tr><td>ケーブルドラム3</td><td>2.42</td><td>2.42</td><td>1.16</td><td>2650</td><td>0.00286</td><td>186</td></tr> <tr><td>ケーブルドラム4</td><td>2.42</td><td>2.42</td><td>1.16</td><td>2270</td><td>0.00334</td><td>215</td></tr> <tr><td>網板3</td><td>3.14</td><td>1.15</td><td>0.08</td><td>2280</td><td>0.00111</td><td>44</td></tr> <tr><td>発電機14</td><td>0.88</td><td>2.04</td><td>1.61</td><td>1780</td><td>0.00241</td><td>150</td></tr> <tr><td>発電機15</td><td>3.37</td><td>1.60</td><td>1.40</td><td>3190</td><td>0.00256</td><td>163</td></tr> <tr><td>プレハブ小屋4</td><td>2.23</td><td>3.15</td><td>2.67</td><td>1700</td><td>0.00831</td><td>326</td></tr> <tr><td>プレハブ小屋5</td><td>2.35</td><td>7.25</td><td>2.45</td><td>1480</td><td>0.01809</td><td>396</td></tr> <tr><td>発電機16</td><td>1.62</td><td>0.88</td><td>2.04</td><td>1780</td><td>0.00242</td><td>150</td></tr> <tr><td>網板4</td><td>3.08</td><td>1.54</td><td>0.22</td><td>902</td><td>0.00441</td><td>260</td></tr> <tr><td>網板5</td><td>3.08</td><td>1.54</td><td>0.22</td><td>902</td><td>0.00441</td><td>260</td></tr> <tr><td>網板6</td><td>1.54</td><td>6.10</td><td>0.021</td><td>1990</td><td>0.00330</td><td>212</td></tr> <tr><td>ドラム部</td><td>0.60</td><td>0.60</td><td>0.90</td><td>245</td><td>0.00388</td><td>241</td></tr> <tr><td>網板7</td><td>6.10</td><td>1.55</td><td>0.022</td><td>1823</td><td>0.00346</td><td>222</td></tr> <tr><td>網板8</td><td>3.68</td><td>1.55</td><td>0.022</td><td>911</td><td>0.00351</td><td>224</td></tr> <tr><td>プレハブ小屋6</td><td>2.35</td><td>8.45</td><td>2.45</td><td>1150</td><td>0.01822</td><td>397</td></tr> <tr><td>空調室外機1</td><td>0.77</td><td>0.86</td><td>1.33</td><td>220</td><td>0.00850</td><td>328</td></tr> <tr><td>空調室外機2</td><td>0.77</td><td>0.86</td><td>1.33</td><td>220</td><td>0.00850</td><td>328</td></tr> <tr><td>網板9</td><td>1.53</td><td>6.40</td><td>0.022</td><td>1700</td><td>0.00385</td><td>240</td></tr> <tr><td>発電機17</td><td>0.70</td><td>1.55</td><td>1.20</td><td>820</td><td>0.00305</td><td>198</td></tr> <tr><td>除塵装置手摺</td><td>6.00</td><td>5.00</td><td>5.60</td><td>14000</td><td>0.00432</td><td>257</td></tr> <tr><td>網板10</td><td>1.90</td><td>1.90</td><td>0.18</td><td>5120</td><td>0.00952</td><td>18</td></tr> <tr><td>空調室外機3</td><td>0.77</td><td>0.86</td><td>1.33</td><td>220</td><td>0.00850</td><td>328</td></tr> <tr><td>空調室外機4</td><td>0.77</td><td>0.86</td><td>1.33</td><td>180</td><td>0.01038</td><td>340</td></tr> <tr><td>発電機18</td><td>1.08</td><td>3.33</td><td>1.31</td><td>2360</td><td>0.00263</td><td>169</td></tr> <tr><td>発電機19</td><td>0.65</td><td>1.49</td><td>1.11</td><td>670</td><td>0.00330</td><td>212</td></tr> <tr><td>網板11</td><td>2.60</td><td>2.00</td><td>0.008</td><td>260</td><td>0.01021</td><td>339</td></tr> <tr><td>網板12</td><td>1.20</td><td>3.58</td><td>0.01</td><td>340</td><td>0.00840</td><td>327</td></tr> <tr><td>プレハブ小屋7</td><td>6.15</td><td>2.30</td><td>2.50</td><td>1570</td><td>0.01483</td><td>367</td></tr> <tr><td>空調室外機5</td><td>0.72</td><td>0.92</td><td>1.34</td><td>179</td><td>0.01055</td><td>341</td></tr> <tr><td>発電機20</td><td>0.65</td><td>1.50</td><td>0.95</td><td>580</td><td>0.00344</td><td>221</td></tr> <tr><td>コンテナ1</td><td>2.44</td><td>12.20</td><td>2.60</td><td>5500</td><td>0.00519</td><td>283</td></tr> <tr><td>発電機21</td><td>0.65</td><td>1.48</td><td>0.95</td><td>580</td><td>0.00340</td><td>218</td></tr> <tr><td>プレハブ小屋8</td><td>2.28</td><td>7.36</td><td>2.62</td><td>1870</td><td>0.01519</td><td>379</td></tr> <tr><td>プレハブ小屋9</td><td>1.85</td><td>3.53</td><td>2.60</td><td>120</td><td>0.01922</td><td>403</td></tr> <tr><td>発電機22</td><td>1.48</td><td>0.65</td><td>1.11</td><td>670</td><td>0.00328</td><td>211</td></tr> <tr><td>コンテナート部</td><td>0.66</td><td>1.35</td><td>0.20</td><td>410</td><td>0.00209</td><td>120</td></tr> <tr><td>網板かご1</td><td>0.62</td><td>1.81</td><td>1.46</td><td>170</td><td>0.01614</td><td>396</td></tr> <tr><td>網板かご2</td><td>1.30</td><td>1.30</td><td>1.00</td><td>180</td><td>0.01573</td><td>375</td></tr> </tbody> </table> <table border="1"> <thead> <tr> <th>飛来物</th> <th>長さ[m]</th> <th>幅[m]</th> <th>高さ[m]</th> <th>質量[kg]</th> <th>密度パラメータ C₀A/m²/kg</th> <th>飛散距離[m]</th> </tr> </thead> <tbody> <tr><td>プレハブ小屋10</td><td>2.47</td><td>7.20</td><td>2.68</td><td>1400</td><td>0.02061</td><td>416</td></tr> <tr><td>網板かご3</td><td>0.64</td><td>1.84</td><td>1.20</td><td>150</td><td>0.01828</td><td>397</td></tr> <tr><td>プレハブ小屋11</td><td>1.25</td><td>1.25</td><td>2.27</td><td>250</td><td>0.01911</td><td>402</td></tr> <tr><td>プレハブ小屋12</td><td>1.84</td><td>2.64</td><td>2.45</td><td>800</td><td>0.01661</td><td>385</td></tr> <tr><td>網板かご4</td><td>1.60</td><td>1.00</td><td>1.00</td><td>2000</td><td>0.00999</td><td>38</td></tr> <tr><td>プレハブ小屋13</td><td>7.25</td><td>2.40</td><td>2.90</td><td>1400</td><td>0.02140</td><td>422</td></tr> <tr><td>コンテナ2</td><td>1.73</td><td>3.10</td><td>1.90</td><td>1200</td><td>0.00727</td><td>218</td></tr> <tr><td>排水船</td><td>4.70</td><td>2.60</td><td>1.00</td><td>3060</td><td>0.00352</td><td>226</td></tr> <tr><td>コンテナ3</td><td>4.88</td><td>2.37</td><td>2.15</td><td>1600</td><td>0.01092</td><td>342</td></tr> <tr><td>コンテナ4</td><td>3.893</td><td>2.10</td><td>2.225</td><td>3950</td><td>0.00360</td><td>329</td></tr> <tr><td>自動販売機</td><td>0.85</td><td>1.40</td><td>1.90</td><td>450</td><td>0.00802</td><td>325</td></tr> <tr><td>プレハブ小屋14</td><td>6.00</td><td>3.06</td><td>2.08</td><td>2000</td><td>0.01228</td><td>347</td></tr> </tbody> </table>	飛来物	長さ[m]	幅[m]	高さ[m]	質量[kg]	密度パラメータ C ₀ A/m ² /kg	飛散距離[m]	発電機1	0.80	1.87	1.05	1440	0.00172	85	発電機2	0.95	2.09	1.30	4290	0.00092	24	発電機3	1.40	3.90	1.76	5040	0.00194	105	発電機4	0.98	2.09	1.55	1690	0.00266	172	タンク	3.08	9.20	3.45	95805	0.00049	15	発電機5	0.98	2.09	1.55	1690	0.00266	172	網板1	1.53	3.06	0.022	911	0.00344	221	プレハブ小屋1	4.50	3.50	2.30	1735	0.01380	354	発電機6	0.95	2.09	1.55	1690	0.00266	172	発電機7	1.18	2.45	1.83	2150	0.00229	139	発電機8	0.70	1.55	1.24	820	0.00312	202	発電機9	0.98	2.09	1.55	1690	0.00266	172	ケーブルドラム1	2.40	2.40	1.17	3050	0.00247	154	発電機10	0.98	2.09	1.55	1690	0.00266	172	プレハブ小屋2	1.92	1.85	2.64	500	0.01783	395	網板2	6.11	1.53	0.02	1480	0.00421	253	発電機11	0.98	2.09	1.55	1690	0.00266	172	カードル	1.01	1.39	1.41	1500	0.00211	122	発電機12	1.74	0.88	1.35	1170	0.00286	186	発電機13	0.65	1.48	1.11	670	0.00528	211	プレハブ小屋3	1.94	1.94	2.16	490	0.01336	301	ケーブルドラム2	2.01	2.01	1.00	1330	0.00490	245	ケーブルドラム3	2.42	2.42	1.16	2650	0.00286	186	ケーブルドラム4	2.42	2.42	1.16	2270	0.00334	215	網板3	3.14	1.15	0.08	2280	0.00111	44	発電機14	0.88	2.04	1.61	1780	0.00241	150	発電機15	3.37	1.60	1.40	3190	0.00256	163	プレハブ小屋4	2.23	3.15	2.67	1700	0.00831	326	プレハブ小屋5	2.35	7.25	2.45	1480	0.01809	396	発電機16	1.62	0.88	2.04	1780	0.00242	150	網板4	3.08	1.54	0.22	902	0.00441	260	網板5	3.08	1.54	0.22	902	0.00441	260	網板6	1.54	6.10	0.021	1990	0.00330	212	ドラム部	0.60	0.60	0.90	245	0.00388	241	網板7	6.10	1.55	0.022	1823	0.00346	222	網板8	3.68	1.55	0.022	911	0.00351	224	プレハブ小屋6	2.35	8.45	2.45	1150	0.01822	397	空調室外機1	0.77	0.86	1.33	220	0.00850	328	空調室外機2	0.77	0.86	1.33	220	0.00850	328	網板9	1.53	6.40	0.022	1700	0.00385	240	発電機17	0.70	1.55	1.20	820	0.00305	198	除塵装置手摺	6.00	5.00	5.60	14000	0.00432	257	網板10	1.90	1.90	0.18	5120	0.00952	18	空調室外機3	0.77	0.86	1.33	220	0.00850	328	空調室外機4	0.77	0.86	1.33	180	0.01038	340	発電機18	1.08	3.33	1.31	2360	0.00263	169	発電機19	0.65	1.49	1.11	670	0.00330	212	網板11	2.60	2.00	0.008	260	0.01021	339	網板12	1.20	3.58	0.01	340	0.00840	327	プレハブ小屋7	6.15	2.30	2.50	1570	0.01483	367	空調室外機5	0.72	0.92	1.34	179	0.01055	341	発電機20	0.65	1.50	0.95	580	0.00344	221	コンテナ1	2.44	12.20	2.60	5500	0.00519	283	発電機21	0.65	1.48	0.95	580	0.00340	218	プレハブ小屋8	2.28	7.36	2.62	1870	0.01519	379	プレハブ小屋9	1.85	3.53	2.60	120	0.01922	403	発電機22	1.48	0.65	1.11	670	0.00328	211	コンテナート部	0.66	1.35	0.20	410	0.00209	120	網板かご1	0.62	1.81	1.46	170	0.01614	396	網板かご2	1.30	1.30	1.00	180	0.01573	375	飛来物	長さ[m]	幅[m]	高さ[m]	質量[kg]	密度パラメータ C ₀ A/m ² /kg	飛散距離[m]	プレハブ小屋10	2.47	7.20	2.68	1400	0.02061	416	網板かご3	0.64	1.84	1.20	150	0.01828	397	プレハブ小屋11	1.25	1.25	2.27	250	0.01911	402	プレハブ小屋12	1.84	2.64	2.45	800	0.01661	385	網板かご4	1.60	1.00	1.00	2000	0.00999	38	プレハブ小屋13	7.25	2.40	2.90	1400	0.02140	422	コンテナ2	1.73	3.10	1.90	1200	0.00727	218	排水船	4.70	2.60	1.00	3060	0.00352	226	コンテナ3	4.88	2.37	2.15	1600	0.01092	342	コンテナ4	3.893	2.10	2.225	3950	0.00360	329	自動販売機	0.85	1.40	1.90	450	0.00802	325	プレハブ小屋14	6.00	3.06	2.08	2000	0.01228	347	<p>【大阪】 設計方針の相違 ・泊では、車両以外の物品に対して飛散防止対策を実施する範囲を定めており、代表的な物品の飛散評価結果を記載している。</p>
飛来物	長さ[m]	幅[m]	高さ[m]	質量[kg]	密度パラメータ C ₀ A/m ² /kg	飛散距離[m]																																																																																																																																																																																																																																																																																																																																																																																																																																																																																																																																			
発電機1	0.80	1.87	1.05	1440	0.00172	85																																																																																																																																																																																																																																																																																																																																																																																																																																																																																																																																			
発電機2	0.95	2.09	1.30	4290	0.00092	24																																																																																																																																																																																																																																																																																																																																																																																																																																																																																																																																			
発電機3	1.40	3.90	1.76	5040	0.00194	105																																																																																																																																																																																																																																																																																																																																																																																																																																																																																																																																			
発電機4	0.98	2.09	1.55	1690	0.00266	172																																																																																																																																																																																																																																																																																																																																																																																																																																																																																																																																			
タンク	3.08	9.20	3.45	95805	0.00049	15																																																																																																																																																																																																																																																																																																																																																																																																																																																																																																																																			
発電機5	0.98	2.09	1.55	1690	0.00266	172																																																																																																																																																																																																																																																																																																																																																																																																																																																																																																																																			
網板1	1.53	3.06	0.022	911	0.00344	221																																																																																																																																																																																																																																																																																																																																																																																																																																																																																																																																			
プレハブ小屋1	4.50	3.50	2.30	1735	0.01380	354																																																																																																																																																																																																																																																																																																																																																																																																																																																																																																																																			
発電機6	0.95	2.09	1.55	1690	0.00266	172																																																																																																																																																																																																																																																																																																																																																																																																																																																																																																																																			
発電機7	1.18	2.45	1.83	2150	0.00229	139																																																																																																																																																																																																																																																																																																																																																																																																																																																																																																																																			
発電機8	0.70	1.55	1.24	820	0.00312	202																																																																																																																																																																																																																																																																																																																																																																																																																																																																																																																																			
発電機9	0.98	2.09	1.55	1690	0.00266	172																																																																																																																																																																																																																																																																																																																																																																																																																																																																																																																																			
ケーブルドラム1	2.40	2.40	1.17	3050	0.00247	154																																																																																																																																																																																																																																																																																																																																																																																																																																																																																																																																			
発電機10	0.98	2.09	1.55	1690	0.00266	172																																																																																																																																																																																																																																																																																																																																																																																																																																																																																																																																			
プレハブ小屋2	1.92	1.85	2.64	500	0.01783	395																																																																																																																																																																																																																																																																																																																																																																																																																																																																																																																																			
網板2	6.11	1.53	0.02	1480	0.00421	253																																																																																																																																																																																																																																																																																																																																																																																																																																																																																																																																			
発電機11	0.98	2.09	1.55	1690	0.00266	172																																																																																																																																																																																																																																																																																																																																																																																																																																																																																																																																			
カードル	1.01	1.39	1.41	1500	0.00211	122																																																																																																																																																																																																																																																																																																																																																																																																																																																																																																																																			
発電機12	1.74	0.88	1.35	1170	0.00286	186																																																																																																																																																																																																																																																																																																																																																																																																																																																																																																																																			
発電機13	0.65	1.48	1.11	670	0.00528	211																																																																																																																																																																																																																																																																																																																																																																																																																																																																																																																																			
プレハブ小屋3	1.94	1.94	2.16	490	0.01336	301																																																																																																																																																																																																																																																																																																																																																																																																																																																																																																																																			
ケーブルドラム2	2.01	2.01	1.00	1330	0.00490	245																																																																																																																																																																																																																																																																																																																																																																																																																																																																																																																																			
ケーブルドラム3	2.42	2.42	1.16	2650	0.00286	186																																																																																																																																																																																																																																																																																																																																																																																																																																																																																																																																			
ケーブルドラム4	2.42	2.42	1.16	2270	0.00334	215																																																																																																																																																																																																																																																																																																																																																																																																																																																																																																																																			
網板3	3.14	1.15	0.08	2280	0.00111	44																																																																																																																																																																																																																																																																																																																																																																																																																																																																																																																																			
発電機14	0.88	2.04	1.61	1780	0.00241	150																																																																																																																																																																																																																																																																																																																																																																																																																																																																																																																																			
発電機15	3.37	1.60	1.40	3190	0.00256	163																																																																																																																																																																																																																																																																																																																																																																																																																																																																																																																																			
プレハブ小屋4	2.23	3.15	2.67	1700	0.00831	326																																																																																																																																																																																																																																																																																																																																																																																																																																																																																																																																			
プレハブ小屋5	2.35	7.25	2.45	1480	0.01809	396																																																																																																																																																																																																																																																																																																																																																																																																																																																																																																																																			
発電機16	1.62	0.88	2.04	1780	0.00242	150																																																																																																																																																																																																																																																																																																																																																																																																																																																																																																																																			
網板4	3.08	1.54	0.22	902	0.00441	260																																																																																																																																																																																																																																																																																																																																																																																																																																																																																																																																			
網板5	3.08	1.54	0.22	902	0.00441	260																																																																																																																																																																																																																																																																																																																																																																																																																																																																																																																																			
網板6	1.54	6.10	0.021	1990	0.00330	212																																																																																																																																																																																																																																																																																																																																																																																																																																																																																																																																			
ドラム部	0.60	0.60	0.90	245	0.00388	241																																																																																																																																																																																																																																																																																																																																																																																																																																																																																																																																			
網板7	6.10	1.55	0.022	1823	0.00346	222																																																																																																																																																																																																																																																																																																																																																																																																																																																																																																																																			
網板8	3.68	1.55	0.022	911	0.00351	224																																																																																																																																																																																																																																																																																																																																																																																																																																																																																																																																			
プレハブ小屋6	2.35	8.45	2.45	1150	0.01822	397																																																																																																																																																																																																																																																																																																																																																																																																																																																																																																																																			
空調室外機1	0.77	0.86	1.33	220	0.00850	328																																																																																																																																																																																																																																																																																																																																																																																																																																																																																																																																			
空調室外機2	0.77	0.86	1.33	220	0.00850	328																																																																																																																																																																																																																																																																																																																																																																																																																																																																																																																																			
網板9	1.53	6.40	0.022	1700	0.00385	240																																																																																																																																																																																																																																																																																																																																																																																																																																																																																																																																			
発電機17	0.70	1.55	1.20	820	0.00305	198																																																																																																																																																																																																																																																																																																																																																																																																																																																																																																																																			
除塵装置手摺	6.00	5.00	5.60	14000	0.00432	257																																																																																																																																																																																																																																																																																																																																																																																																																																																																																																																																			
網板10	1.90	1.90	0.18	5120	0.00952	18																																																																																																																																																																																																																																																																																																																																																																																																																																																																																																																																			
空調室外機3	0.77	0.86	1.33	220	0.00850	328																																																																																																																																																																																																																																																																																																																																																																																																																																																																																																																																			
空調室外機4	0.77	0.86	1.33	180	0.01038	340																																																																																																																																																																																																																																																																																																																																																																																																																																																																																																																																			
発電機18	1.08	3.33	1.31	2360	0.00263	169																																																																																																																																																																																																																																																																																																																																																																																																																																																																																																																																			
発電機19	0.65	1.49	1.11	670	0.00330	212																																																																																																																																																																																																																																																																																																																																																																																																																																																																																																																																			
網板11	2.60	2.00	0.008	260	0.01021	339																																																																																																																																																																																																																																																																																																																																																																																																																																																																																																																																			
網板12	1.20	3.58	0.01	340	0.00840	327																																																																																																																																																																																																																																																																																																																																																																																																																																																																																																																																			
プレハブ小屋7	6.15	2.30	2.50	1570	0.01483	367																																																																																																																																																																																																																																																																																																																																																																																																																																																																																																																																			
空調室外機5	0.72	0.92	1.34	179	0.01055	341																																																																																																																																																																																																																																																																																																																																																																																																																																																																																																																																			
発電機20	0.65	1.50	0.95	580	0.00344	221																																																																																																																																																																																																																																																																																																																																																																																																																																																																																																																																			
コンテナ1	2.44	12.20	2.60	5500	0.00519	283																																																																																																																																																																																																																																																																																																																																																																																																																																																																																																																																			
発電機21	0.65	1.48	0.95	580	0.00340	218																																																																																																																																																																																																																																																																																																																																																																																																																																																																																																																																			
プレハブ小屋8	2.28	7.36	2.62	1870	0.01519	379																																																																																																																																																																																																																																																																																																																																																																																																																																																																																																																																			
プレハブ小屋9	1.85	3.53	2.60	120	0.01922	403																																																																																																																																																																																																																																																																																																																																																																																																																																																																																																																																			
発電機22	1.48	0.65	1.11	670	0.00328	211																																																																																																																																																																																																																																																																																																																																																																																																																																																																																																																																			
コンテナート部	0.66	1.35	0.20	410	0.00209	120																																																																																																																																																																																																																																																																																																																																																																																																																																																																																																																																			
網板かご1	0.62	1.81	1.46	170	0.01614	396																																																																																																																																																																																																																																																																																																																																																																																																																																																																																																																																			
網板かご2	1.30	1.30	1.00	180	0.01573	375																																																																																																																																																																																																																																																																																																																																																																																																																																																																																																																																			
飛来物	長さ[m]	幅[m]	高さ[m]	質量[kg]	密度パラメータ C ₀ A/m ² /kg	飛散距離[m]																																																																																																																																																																																																																																																																																																																																																																																																																																																																																																																																			
プレハブ小屋10	2.47	7.20	2.68	1400	0.02061	416																																																																																																																																																																																																																																																																																																																																																																																																																																																																																																																																			
網板かご3	0.64	1.84	1.20	150	0.01828	397																																																																																																																																																																																																																																																																																																																																																																																																																																																																																																																																			
プレハブ小屋11	1.25	1.25	2.27	250	0.01911	402																																																																																																																																																																																																																																																																																																																																																																																																																																																																																																																																			
プレハブ小屋12	1.84	2.64	2.45	800	0.01661	385																																																																																																																																																																																																																																																																																																																																																																																																																																																																																																																																			
網板かご4	1.60	1.00	1.00	2000	0.00999	38																																																																																																																																																																																																																																																																																																																																																																																																																																																																																																																																			
プレハブ小屋13	7.25	2.40	2.90	1400	0.02140	422																																																																																																																																																																																																																																																																																																																																																																																																																																																																																																																																			
コンテナ2	1.73	3.10	1.90	1200	0.00727	218																																																																																																																																																																																																																																																																																																																																																																																																																																																																																																																																			
排水船	4.70	2.60	1.00	3060	0.00352	226																																																																																																																																																																																																																																																																																																																																																																																																																																																																																																																																			
コンテナ3	4.88	2.37	2.15	1600	0.01092	342																																																																																																																																																																																																																																																																																																																																																																																																																																																																																																																																			
コンテナ4	3.893	2.10	2.225	3950	0.00360	329																																																																																																																																																																																																																																																																																																																																																																																																																																																																																																																																			
自動販売機	0.85	1.40	1.90	450	0.00802	325																																																																																																																																																																																																																																																																																																																																																																																																																																																																																																																																			
プレハブ小屋14	6.00	3.06	2.08	2000	0.01228	347																																																																																																																																																																																																																																																																																																																																																																																																																																																																																																																																			

赤字：設備、運用又は体制の相違（設計方針の相違）
 青字：記載箇所又は記載内容の相違（記載方針の相違）
 緑字：記載表現、設備名称の相違（実質的な相違なし）

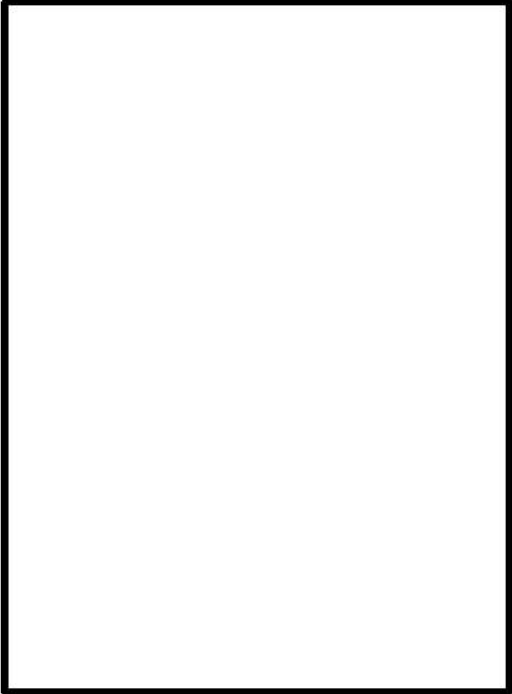
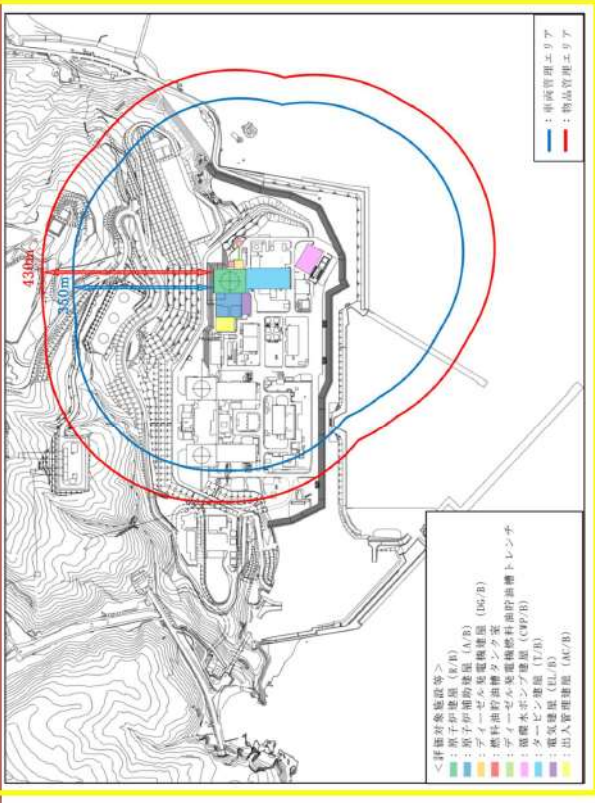
大飯発電所3/4号炉	女川原子力発電所2号炉	泊発電所3号炉	相違理由
<p style="text-align: right;">別紙1</p> <div style="border: 1px solid black; width: 100%; height: 100%; display: flex; align-items: center; justify-content: center;">  </div> <p style="text-align: center;">図1 大飯発電所における車両の飛散防止対策範囲</p> <p style="text-align: center; border: 1px solid black; padding: 2px;">枠内は機密に係る事項ですので公開することはできません。</p>		<div style="border: 1px solid black; width: 100%; height: 100%; display: flex; align-items: center; justify-content: center;">  </div> <p style="text-align: center;">図1 泊発電所における車両及び物品管理エリア</p>	<p>【大飯】</p> <p>設計方針の相違</p> <ul style="list-style-type: none"> ・大飯では、車両に対して飛散防止対策を実施する範囲を示している。泊では、車両に加え、車両以外の物品に対して飛散防止対策を実施する範囲を示している。

赤字：設備、運用又は体制の相違（設計方針の相違）
 青字：記載箇所又は記載内容の相違（記載方針の相違）
 緑字：記載表現、設備名称の相違（実質的な相違なし）

大飯発電所3/4号炉	女川原子力発電所2号炉	泊発電所3号炉	相違理由																																		
<p>(補足説明資料)</p> <p>1.1. 建屋開口部の調査結果について</p> <p>竜巻防護施設に影響を及ぼす可能性がある建屋開口部を調査した結果を第3図～第12図に示す。調査の結果、第10図に示すブローアウトパネルについて設計飛来物が衝突した場合に貫通し、竜巻防護施設に影響を与える可能性が否定できないため、防護対策を実施する。</p>		<p style="text-align: right;">添付資料 3.11</p> <p>外部事象防護対象施設に影響を及ぼす可能性がある建屋開口部について</p> <p>外部事象防護対象施設に影響を及ぼす可能性がある建屋開口部の有無を評価した結果、以下の建屋開口部については、設計飛来物が貫通した場合、設計飛来物の衝突により当該建屋開口部周辺に設置されている外部事象防護対象施設の安全機能を損なう可能性があることから、竜巻飛来物防護対策設備又は運用による竜巻防護対策を実施する。</p> <div style="border: 1px solid red; padding: 5px; margin: 10px 0;"> <p style="text-align: center;">表1 竜巻防護対策を実施する建屋開口部</p> <table border="1" style="width: 100%; border-collapse: collapse;"> <thead> <tr> <th>No.</th> <th>建屋開口部</th> <th>建屋開口部周辺の外部事象防護対象施設</th> <th>竜巻防護対策</th> <th>参照図面</th> </tr> </thead> <tbody> <tr> <td rowspan="2">1</td> <td>①A-ディーゼル発電機室扉 ②B-ディーゼル発電機室扉</td> <td rowspan="2">ディーゼル発電機設備(A、B-ディーゼル発電機他)</td> <td>竜巻防護扉の設置^{※2} (ディーゼル発電機建屋)</td> <td rowspan="2">図1 (T.P. 10. 3m)</td> </tr> <tr> <td>③A-ディーゼル発電機室排気口 ④B-ディーゼル発電機室排気口</td> <td>竜巻防護板の設置^{※2} (ディーゼル発電機建屋)</td> </tr> <tr> <td>2</td> <td>⑤タービン建屋連絡通路扉</td> <td>空調用冷水系統配管</td> <td>竜巻防護扉の設置^{※2} (原子炉建屋(周辺補機棟))</td> <td>図1 (T.P. 10. 3m)</td> </tr> <tr> <td>3</td> <td>⑥トラックアクセスエリア扉</td> <td>原子炉補機冷却水系統配管 制御用空気系統配管 空調用冷水系統配管</td> <td>竜巻防護扉の設置^{※2} (原子炉建屋(周辺補機棟))</td> <td>図1 (T.P. 10. 3m)</td> </tr> <tr> <td rowspan="2">4</td> <td>⑦A-吸気ガラリ室扉 ⑧B-吸気ガラリ室扉</td> <td rowspan="2">A、B-蓄熱室加熱器</td> <td>竜巻防護鋼板の設置^{※1} (ディーゼル発電機建屋)</td> <td rowspan="2">図3 (T.P. 17. 8m)</td> </tr> <tr> <td>⑨A-吸気ガラリ室吸気口 ⑩B-吸気ガラリ室吸気口</td> <td>竜巻防護扉の設置^{※2} (ディーゼル発電機建屋)</td> </tr> <tr> <td>5</td> <td>⑪A-原子炉建屋給気ガラリアクセス扉</td> <td>ディーゼル発電機室換気装置(A、B-ディーゼル発電機室給気ファン他) 制御用空気圧縮機室空調装置(ダクト)</td> <td>竜巻防護鋼板の設置^{※2} (原子炉建屋(周辺補機棟))</td> <td>図3 (T.P. 17. 8m)</td> </tr> </tbody> </table> </div>	No.	建屋開口部	建屋開口部周辺の外部事象防護対象施設	竜巻防護対策	参照図面	1	①A-ディーゼル発電機室扉 ②B-ディーゼル発電機室扉	ディーゼル発電機設備(A、B-ディーゼル発電機他)	竜巻防護扉の設置 ^{※2} (ディーゼル発電機建屋)	図1 (T.P. 10. 3m)	③A-ディーゼル発電機室排気口 ④B-ディーゼル発電機室排気口	竜巻防護板の設置 ^{※2} (ディーゼル発電機建屋)	2	⑤タービン建屋連絡通路扉	空調用冷水系統配管	竜巻防護扉の設置 ^{※2} (原子炉建屋(周辺補機棟))	図1 (T.P. 10. 3m)	3	⑥トラックアクセスエリア扉	原子炉補機冷却水系統配管 制御用空気系統配管 空調用冷水系統配管	竜巻防護扉の設置 ^{※2} (原子炉建屋(周辺補機棟))	図1 (T.P. 10. 3m)	4	⑦A-吸気ガラリ室扉 ⑧B-吸気ガラリ室扉	A、B-蓄熱室加熱器	竜巻防護鋼板の設置 ^{※1} (ディーゼル発電機建屋)	図3 (T.P. 17. 8m)	⑨A-吸気ガラリ室吸気口 ⑩B-吸気ガラリ室吸気口	竜巻防護扉の設置 ^{※2} (ディーゼル発電機建屋)	5	⑪A-原子炉建屋給気ガラリアクセス扉	ディーゼル発電機室換気装置(A、B-ディーゼル発電機室給気ファン他) 制御用空気圧縮機室空調装置(ダクト)	竜巻防護鋼板の設置 ^{※2} (原子炉建屋(周辺補機棟))	図3 (T.P. 17. 8m)	<p>【女川】 記載の充実(大飯参照)</p> <p>【大飯】 記載表現の相違</p> <p>【大飯】 設計方針の相違 ・対象建屋の開口部を抽出した上で、設計飛来物の貫通によって外部事象防護対象施設(大飯では竜巻防護施設)に影響を与える可能性がある建屋開口部を特定して、必要な防護対策を実施する考え方は同じであるが、敷地形状や建屋・設備の配置等の相違により、対象となる建屋開口部は異なっている。</p>
No.	建屋開口部	建屋開口部周辺の外部事象防護対象施設	竜巻防護対策	参照図面																																	
1	①A-ディーゼル発電機室扉 ②B-ディーゼル発電機室扉	ディーゼル発電機設備(A、B-ディーゼル発電機他)	竜巻防護扉の設置 ^{※2} (ディーゼル発電機建屋)	図1 (T.P. 10. 3m)																																	
	③A-ディーゼル発電機室排気口 ④B-ディーゼル発電機室排気口		竜巻防護板の設置 ^{※2} (ディーゼル発電機建屋)																																		
2	⑤タービン建屋連絡通路扉	空調用冷水系統配管	竜巻防護扉の設置 ^{※2} (原子炉建屋(周辺補機棟))	図1 (T.P. 10. 3m)																																	
3	⑥トラックアクセスエリア扉	原子炉補機冷却水系統配管 制御用空気系統配管 空調用冷水系統配管	竜巻防護扉の設置 ^{※2} (原子炉建屋(周辺補機棟))	図1 (T.P. 10. 3m)																																	
4	⑦A-吸気ガラリ室扉 ⑧B-吸気ガラリ室扉	A、B-蓄熱室加熱器	竜巻防護鋼板の設置 ^{※1} (ディーゼル発電機建屋)	図3 (T.P. 17. 8m)																																	
	⑨A-吸気ガラリ室吸気口 ⑩B-吸気ガラリ室吸気口		竜巻防護扉の設置 ^{※2} (ディーゼル発電機建屋)																																		
5	⑪A-原子炉建屋給気ガラリアクセス扉	ディーゼル発電機室換気装置(A、B-ディーゼル発電機室給気ファン他) 制御用空気圧縮機室空調装置(ダクト)	竜巻防護鋼板の設置 ^{※2} (原子炉建屋(周辺補機棟))	図3 (T.P. 17. 8m)																																	

赤字：設備、運用又は体制の相違（設計方針の相違）
 青字：記載箇所又は記載内容の相違（記載方針の相違）
 緑字：記載表現、設備名称の相違（実質的な相違なし）

大飯発電所3/4号炉	女川原子力発電所2号炉	泊発電所3号炉	相違理由																																													
<p>また、開口部付近に竜巻防護施設が存在する箇所として、3、4号ディーゼル発電機室、4号電動補助給水ポンプ室、3、4号ディーゼル発電機制御盤室が存在する。これらについて、障害物と竜巻防護施設（付属設備含む）との位置関係を評価した結果、3、4号機ディーゼル発電機の付属設備に飛来物が衝突する可能性があるが、開口部であるディーゼル発電機室水密扉にて設計飛来物である鋼製材の貫通を阻止できることを確認した。3、4号ディーゼル発電機室内、4号電動補助給水ポンプ室内及び3、4号ディーゼル発電機制御盤室内の竜巻防護施設と障害物の位置関係を別紙1、ディーゼル発電機室水密扉の貫通評価結果を別紙2に示す。</p>		<table border="1"> <thead> <tr> <th>No.</th> <th>建屋開口部</th> <th>建屋開口部周辺の外部事象防護対象施設</th> <th>竜巻防護対策</th> <th>参照図面</th> </tr> </thead> <tbody> <tr> <td>6</td> <td>①B-原子が建屋給気ガラリアアクセス扉</td> <td>ディーゼル発電機室換気装置（C、D-ディーゼル発電機室給気ファン他） 制御用空気圧縮機室空調装置（ダクト） 補助給水系統配管</td> <td>竜巻防護鋼板の設置^{※2} （原子が建屋（周辺補機棟））</td> <td>図3 （T.P.17.8m）</td> </tr> <tr> <td>7</td> <td>②タービン建屋連絡通路扉</td> <td>補助給水系統配管</td> <td>竜巻防護壁の設置^{※2} （原子が建屋（周辺補機棟））</td> <td>図3 （T.P.17.8m）</td> </tr> <tr> <td>8</td> <td>③主蒸気管室ブローアウトパネル ④主蒸気管室ブローアウトパネル</td> <td>主蒸気系統配管及び弁 主給水系統配管及び弁 補助給水系統配管及び弁 制御用空気系統配管及び弁</td> <td>竜巻防護鋼板の設置^{※2} （原子が建屋（周辺補機棟））</td> <td>図5 （T.P.33.1m）</td> </tr> <tr> <td>9</td> <td>⑤燃料取扱棟トラックアクセスエリア扉</td> <td>使用済燃料ピットクレーン</td> <td>燃料取扱作業中止 （原子が建屋（燃料取扱棟））</td> <td>図5 （T.P.33.1m）</td> </tr> <tr> <td>10</td> <td>⑥トラックアクセスエリア（2）扉</td> <td>制御用空気系統配管</td> <td>竜巻防護壁の設置^{※1} （原子が補助建屋）</td> <td>図5 （T.P.33.1m）</td> </tr> <tr> <td>11</td> <td>⑦主蒸気管室上部換気口</td> <td>主蒸気系統配管及び弁 制御用空気系統配管</td> <td>竜巻防護鋼板の設置^{※2} （原子が建屋（周辺補機棟））</td> <td>図7 （T.P.40.3m、 T.P.43.3m）</td> </tr> <tr> <td>12</td> <td>⑧格納容器排気希釈用外気取入ガラリアアクセス扉</td> <td>排気筒（建屋内） 格納容器排気空調装置（ダクト） アニュラス空気浄化設備（ダクト）</td> <td>竜巻防護鋼板の設置^{※2} （原子が建屋（周辺補機棟））</td> <td>図7 （T.P.40.3m、 T.P.43.3m）</td> </tr> <tr> <td>13</td> <td>⑨原子が補機冷却水サージタンク・空調用冷水節蛋タンク室扉</td> <td>原子が補機冷却水サージタンク 原子が補機冷却水系統配管及び弁</td> <td>竜巻防護壁の設置^{※1} （原子が建屋（周辺補機棟））</td> <td>図9 （T.P.43.0m）</td> </tr> </tbody> </table> <p>※1：「蓄熱加熱器」（No.4：①②③④）、「制御用空気系統配管」（No.10）、「原子が補機冷却水サージタンク（配管及び弁含む）」（No.13）については、竜巻防護対策として、当該建屋内に竜巻飛来物防護対策設備（竜巻防護鋼板及び竜巻防護壁）を設置するため、当該建屋開口部周辺に外部事象防護対象施設の安全機能を損なう可能性がある発火又は引火性物質を内包する機器及び漏水漏がないことを確認している。</p> <p>※2：「主蒸気系統配管他」（No.1～3,5～8,11,12）、「蓄熱加熱器」（No.4：①②③）については、竜巻防護鋼板、竜巻防護壁及び竜巻防護扉で当該開口部の竜巻防護対策を実施する。</p>	No.	建屋開口部	建屋開口部周辺の外部事象防護対象施設	竜巻防護対策	参照図面	6	①B-原子が建屋給気ガラリアアクセス扉	ディーゼル発電機室換気装置（C、D-ディーゼル発電機室給気ファン他） 制御用空気圧縮機室空調装置（ダクト） 補助給水系統配管	竜巻防護鋼板の設置 ^{※2} （原子が建屋（周辺補機棟））	図3 （T.P.17.8m）	7	②タービン建屋連絡通路扉	補助給水系統配管	竜巻防護壁の設置 ^{※2} （原子が建屋（周辺補機棟））	図3 （T.P.17.8m）	8	③主蒸気管室ブローアウトパネル ④主蒸気管室ブローアウトパネル	主蒸気系統配管及び弁 主給水系統配管及び弁 補助給水系統配管及び弁 制御用空気系統配管及び弁	竜巻防護鋼板の設置 ^{※2} （原子が建屋（周辺補機棟））	図5 （T.P.33.1m）	9	⑤燃料取扱棟トラックアクセスエリア扉	使用済燃料ピットクレーン	燃料取扱作業中止 （原子が建屋（燃料取扱棟））	図5 （T.P.33.1m）	10	⑥トラックアクセスエリア（2）扉	制御用空気系統配管	竜巻防護壁の設置 ^{※1} （原子が補助建屋）	図5 （T.P.33.1m）	11	⑦主蒸気管室上部換気口	主蒸気系統配管及び弁 制御用空気系統配管	竜巻防護鋼板の設置 ^{※2} （原子が建屋（周辺補機棟））	図7 （T.P.40.3m、 T.P.43.3m）	12	⑧格納容器排気希釈用外気取入ガラリアアクセス扉	排気筒（建屋内） 格納容器排気空調装置（ダクト） アニュラス空気浄化設備（ダクト）	竜巻防護鋼板の設置 ^{※2} （原子が建屋（周辺補機棟））	図7 （T.P.40.3m、 T.P.43.3m）	13	⑨原子が補機冷却水サージタンク・空調用冷水節蛋タンク室扉	原子が補機冷却水サージタンク 原子が補機冷却水系統配管及び弁	竜巻防護壁の設置 ^{※1} （原子が建屋（周辺補機棟））	図9 （T.P.43.0m）	<p>【大飯】 設計方針の相違 ・対象建屋の開口部を抽出した上で、設計飛来物の貫通によって外部事象防護対象施設（大飯では竜巻防護施設）に影響を与える可能性がある建屋開口部を特定して、必要な防護対策を実施する考え方は同じであるが、敷地形状や建屋・設備の配置等の相違により、対象となる建屋開口部は異なっている。</p> <p>【大飯】 設計方針の相違 ・大飯では、開口部付近に竜巻防護施設が設置されている箇所について、障害物と竜巻防護施設の位置関係を評価した結果を別紙1に、また、その中で、設計飛来物が衝突する可能性がある既存水密扉に対して貫通評価を行い、貫通しないことを確認した結果を別紙2に示している。泊で</p>
		No.	建屋開口部	建屋開口部周辺の外部事象防護対象施設	竜巻防護対策	参照図面																																										
6	①B-原子が建屋給気ガラリアアクセス扉	ディーゼル発電機室換気装置（C、D-ディーゼル発電機室給気ファン他） 制御用空気圧縮機室空調装置（ダクト） 補助給水系統配管	竜巻防護鋼板の設置 ^{※2} （原子が建屋（周辺補機棟））	図3 （T.P.17.8m）																																												
7	②タービン建屋連絡通路扉	補助給水系統配管	竜巻防護壁の設置 ^{※2} （原子が建屋（周辺補機棟））	図3 （T.P.17.8m）																																												
8	③主蒸気管室ブローアウトパネル ④主蒸気管室ブローアウトパネル	主蒸気系統配管及び弁 主給水系統配管及び弁 補助給水系統配管及び弁 制御用空気系統配管及び弁	竜巻防護鋼板の設置 ^{※2} （原子が建屋（周辺補機棟））	図5 （T.P.33.1m）																																												
9	⑤燃料取扱棟トラックアクセスエリア扉	使用済燃料ピットクレーン	燃料取扱作業中止 （原子が建屋（燃料取扱棟））	図5 （T.P.33.1m）																																												
10	⑥トラックアクセスエリア（2）扉	制御用空気系統配管	竜巻防護壁の設置 ^{※1} （原子が補助建屋）	図5 （T.P.33.1m）																																												
11	⑦主蒸気管室上部換気口	主蒸気系統配管及び弁 制御用空気系統配管	竜巻防護鋼板の設置 ^{※2} （原子が建屋（周辺補機棟））	図7 （T.P.40.3m、 T.P.43.3m）																																												
12	⑧格納容器排気希釈用外気取入ガラリアアクセス扉	排気筒（建屋内） 格納容器排気空調装置（ダクト） アニュラス空気浄化設備（ダクト）	竜巻防護鋼板の設置 ^{※2} （原子が建屋（周辺補機棟））	図7 （T.P.40.3m、 T.P.43.3m）																																												
13	⑨原子が補機冷却水サージタンク・空調用冷水節蛋タンク室扉	原子が補機冷却水サージタンク 原子が補機冷却水系統配管及び弁	竜巻防護壁の設置 ^{※1} （原子が建屋（周辺補機棟））	図9 （T.P.43.0m）																																												

泊発電所3号炉 DB基準適合性 比較表

赤字：設備、運用又は体制の相違（設計方針の相違）
 青字：記載箇所又は記載内容の相違（記載方針の相違）
 緑字：記載表現、設備名称の相違（実質的な相違なし）

第6条 外部からの衝撃による損傷の防止（竜巻：別添資料1 添付資料3.11）

大飯発電所3/4号炉	女川原子力発電所2号炉	泊発電所3号炉	相違理由
<p>なお、他の開口部については、周辺に竜巻防護施設、竜巻防護施設の安全機能を損なう可能性がある発火性又は引火性物質を内包する機器及び溢水源がないことを確認している。</p>		<p>なお、他の建屋開口部については、周辺に外部事象防護対象施設、外部事象防護対象施設の安全機能を損なう可能性がある発火性又は引火性物質を内包する機器及び溢水源がないことを確認している。</p>	<p>は、設計飛来物の侵入方向にある後背斜面によって侵入角度が斜め下向きとなり、開口部から離れた位置にある外部事象防護対象施設に衝突しないと評価している箇所が1箇所あり、その旨図5に記載し、当該開口部から後背斜面を撮影した写真を掲載している。</p> <p>【大飯】 記載表現の相違</p>

赤字：設備、運用又は体制の相違（設計方針の相違）
 青字：記載箇所又は記載内容の相違（記載方針の相違）
 緑字：記載表現、設備名称の相違（実質的な相違なし）

第6条 外部からの衝撃による損傷の防止（竜巻：別添資料1 添付資料3.11）

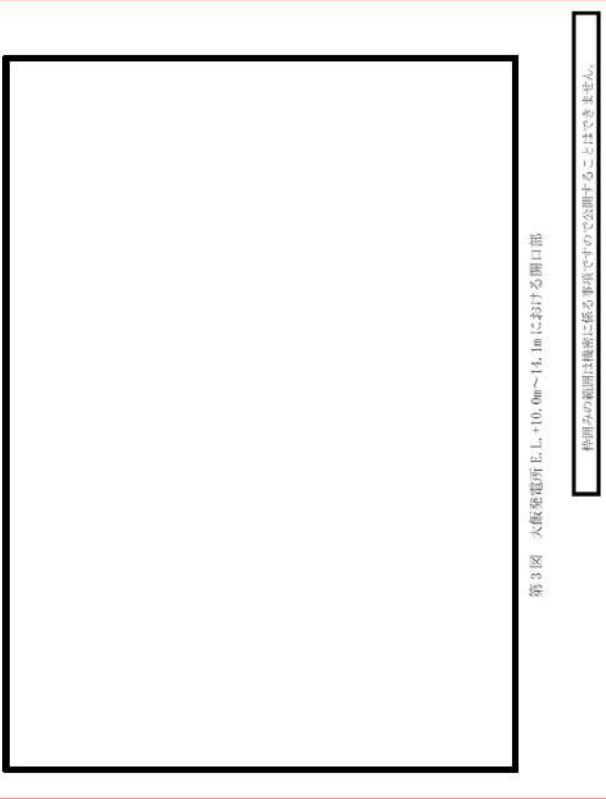
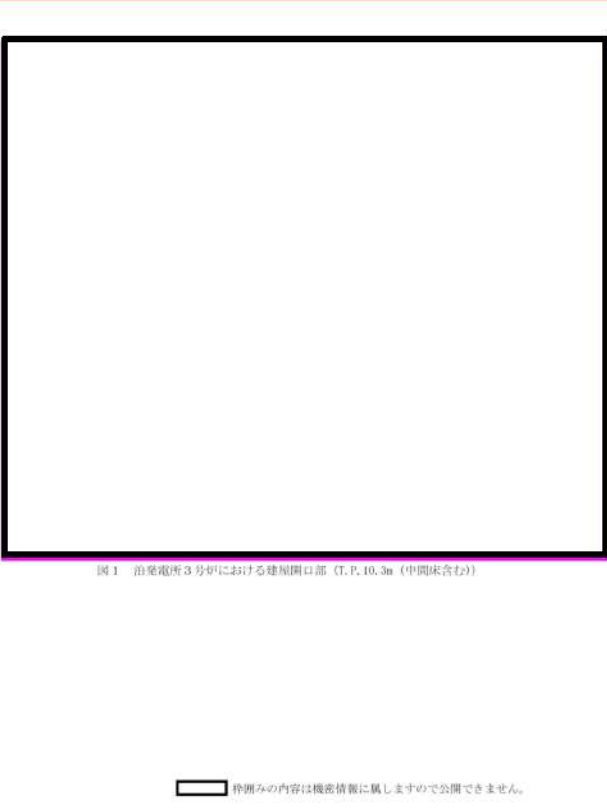
大飯発電所3/4号炉	女川原子力発電所2号炉	泊発電所3号炉	相違理由
 <p>第3図 大飯発電所E.L.+10.0m～14.1mにおける開口部</p> <p>枠囲みの範囲は機密に係る事項ですので公開できません。</p>		 <p>図1 泊発電所3号炉における建屋開口部（T.P.10.3m（中間床含む））</p> <p>枠囲みの内容は機密情報に属しますので公開できません。</p>	<p>【大飯】 建屋開口部の相違 ・プラント設計の相違</p>

赤字：設備、運用又は体制の相違（設計方針の相違）
 青字：記載箇所又は記載内容の相違（記載方針の相違）
 緑字：記載表現、設備名称の相違（実質的な相違なし）

大飯発電所3/4号炉	女川原子力発電所2号炉	泊発電所3号炉	相違理由
<p style="text-align: center;">第4図 大飯発電所主上.L.+10.0m～H.1mにおける開口部の屋内写真(1/4)</p> <p style="text-align: center;">枠囲みの範囲は機密に属する事項ですので公開できません。</p>		<p style="text-align: center;">第2図 泊発電所3号炉における建屋開口部周辺の屋内写真他（T.P.10.3m（中間床含む））（1/2）</p> <p style="text-align: center;">枠囲みの内容は機密情報に属しますので公開できません。</p>	<p>【大飯】 建屋開口部の相違 設備配置の相違 ・プラント設計の相違</p>

赤字：設備、運用又は体制の相違（設計方針の相違）
 青字：記載箇所又は記載内容の相違（記載方針の相違）
 緑字：記載表現、設備名称の相違（実質的な相違なし）

大飯発電所3/4号炉	女川原子力発電所2号炉	泊発電所3号炉	相違理由
<div data-bbox="85 229 622 1200" style="border: 1px solid black; width: 100%; height: 100%;"></div> <div data-bbox="622 245 689 772" style="border: 1px solid black; padding: 2px; width: fit-content; margin-left: auto;"> 検問部の範囲は機密に係る事項ですので公開することはできません。 </div> <div data-bbox="622 485 645 1027" style="text-align: center; margin-top: 10px;"> 第4図 大飯発電所E.L.+10.0m~14.1mにおける開口部の屋内外写真(2/4) </div>		<div data-bbox="1370 268 1953 660" style="border: 1px solid red; padding: 5px;"> <p>当該開口部を背にして屋内を撮影</p> <p>建屋開口部②</p> <p>建屋開口部③（屋外から撮影）</p> <p>当該開口部を覆っているトディーゼル発電機排気フードを貫通した設計機油物外部事象防護対象施設であるディーゼル発電機設備に衝突しないよう、当該フード部にコンクリート製の防護板を設置する。</p> <p>当該開口部を背にして屋内を撮影</p> <p>建屋開口部④</p> <p>建屋開口部⑤（屋外から撮影）</p> <p>当該開口部を覆っているトディーゼル発電機排気フードを貫通した設計機油物外部事象防護対象施設であるディーゼル発電機設備に衝突しないよう、当該フード部にコンクリート製の防護板を設置する。</p> </div> <div data-bbox="1344 1069 1899 1088" style="margin-top: 20px;"> 図2 泊発電所3号炉における建屋開口部周辺の屋内写真他（T.P.10.3m（中間床含む））（2/2） </div>	<p>【大飯】</p> <p>建屋開口部の相違 設備配置の相違 ・プラント設計の相違</p>

赤字：設備、運用又は体制の相違（設計方針の相違）
 青字：記載箇所又は記載内容の相違（記載方針の相違）
 緑字：記載表現、設備名称の相違（実質的な相違なし）

第6条 外部からの衝撃による損傷の防止（竜巻：別添資料1 添付資料3.11）

大飯発電所3/4号炉	女川原子力発電所2号炉	泊発電所3号炉	相違理由
<div data-bbox="85 225 689 1198" style="border: 1px solid black; padding: 10px;"> <p style="text-align: center;">第4図 大飯発電所E.L.+10.0m~14.1mにおける開口部の屋内外写真(3/4)</p> <p style="text-align: right; font-size: small;">枠囲みの範囲は機密に係る事項ですので公開することはありません。</p> </div>			<p>【大飯】 建屋開口部の相違 設備配置の相違 ・プラント設計の相違</p>

赤字：設備、運用又は体制の相違（設計方針の相違）
 青字：記載箇所又は記載内容の相違（記載方針の相違）
 緑字：記載表現、設備名称の相違（実質的な相違なし）

第6条 外部からの衝撃による損傷の防止（竜巻：別添資料1 添付資料3.11）

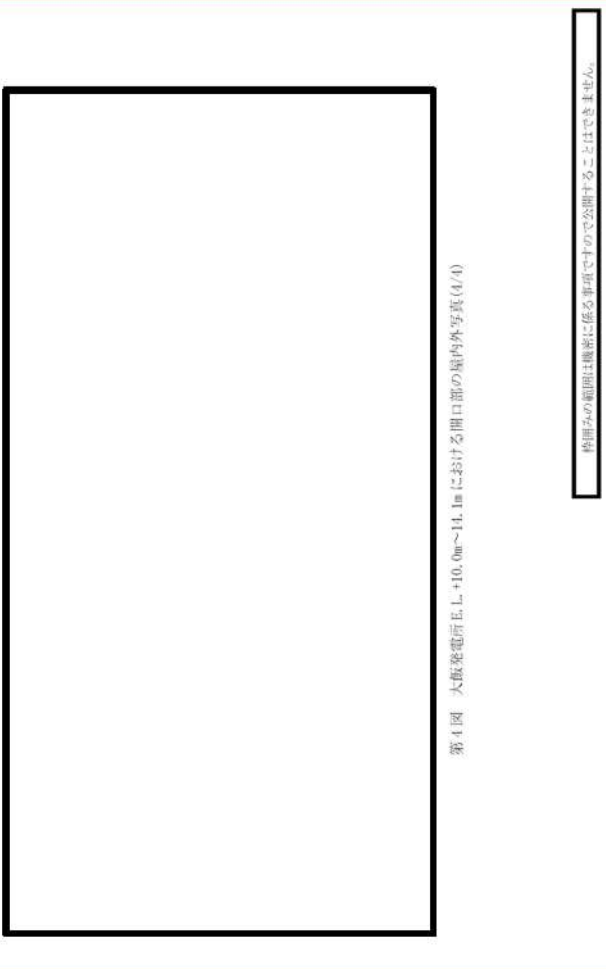
大飯発電所3/4号炉	女川原子力発電所2号炉	泊発電所3号炉	相違理由
<div data-bbox="85 231 689 1204" style="border: 1px solid red; padding: 10px;">  <div data-bbox="526 494 548 989" style="position: absolute; left: 235px; top: 310px; font-size: small;">第4図 大飯発電所E.L.+10.0m~14.1mにおける開口部の屋内外写真(4/4)</div> <div data-bbox="660 239 683 726" style="position: absolute; left: 295px; top: 150px; border: 1px solid black; padding: 2px; font-size: x-small;">内部の範囲は撮影に係る事項ですので公開することはありません。</div> </div>			<p>【大飯】 建屋開口部の相違 設備配置の相違 ・プラント設計の相違</p>

泊発電所3号炉 DB基準適合性 比較表

赤字：設備、運用又は体制の相違（設計方針の相違）
 青字：記載箇所又は記載内容の相違（記載方針の相違）
 緑字：記載表現、設備名称の相違（実質的な相違なし）

第6条 外部からの衝撃による損傷の防止（竜巻：別添資料1 添付資料3.11）

大飯発電所3/4号炉	女川原子力発電所2号炉	泊発電所3号炉	相違理由
		 <p data-bbox="1429 791 1816 807">図3 泊発電所3号炉における建屋開口部（T.F.17.0m（中間床含む））</p> <p data-bbox="1518 1010 1865 1026">□ 枠囲みの内容は機密情報に属しますので公開できません。</p>	<p data-bbox="1977 233 2152 312">【大飯】 建屋開口部の相違 ・プラント設計の相違</p>

赤字：設備、運用又は体制の相違（設計方針の相違）
 青字：記載箇所又は記載内容の相違（記載方針の相違）
 緑字：記載表現、設備名称の相違（実質的な相違なし）

大飯発電所3/4号炉	女川原子力発電所2号炉	泊発電所3号炉	相違理由
		<p>図4 泊発電所3号炉における建屋開口部周辺の屋内写真他（T.P.17.8m（中間床含む））（1/2）</p> <p>□ 枠囲みの内容は機密情報に属しますので公開できません。</p>	<p>【大飯】 建屋開口部の相違 設備配置の相違 ・プラント設計の相違</p>

赤字：設備、運用又は体制の相違（設計方針の相違）
 青字：記載箇所又は記載内容の相違（記載方針の相違）
 緑字：記載表現、設備名称の相違（実質的な相違なし）

大飯発電所3/4号炉	女川原子力発電所2号炉	泊発電所3号炉	相違理由
		<p>図4 泊発電所3号炉における建屋開口部周辺の屋内写真他（Y.P.17.8a（中間床含む））(2/2)</p>	<p>【大飯】 建屋開口部の相違 設備配置の相違 ・プラント設計の相違</p>

赤字：設備、運用又は体制の相違（設計方針の相違）
 青字：記載箇所又は記載内容の相違（記載方針の相違）
 緑字：記載表現、設備名称の相違（実質的な相違なし）

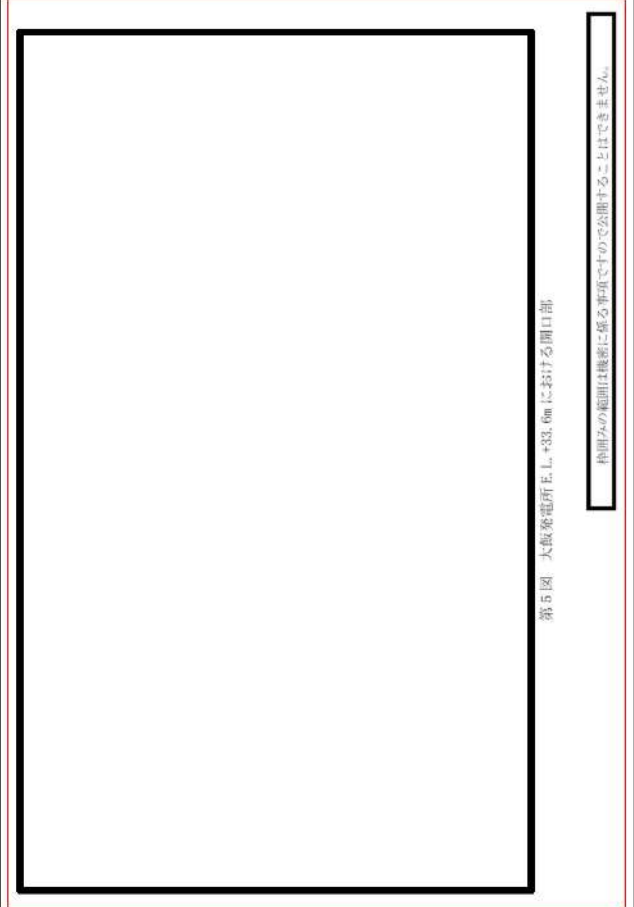
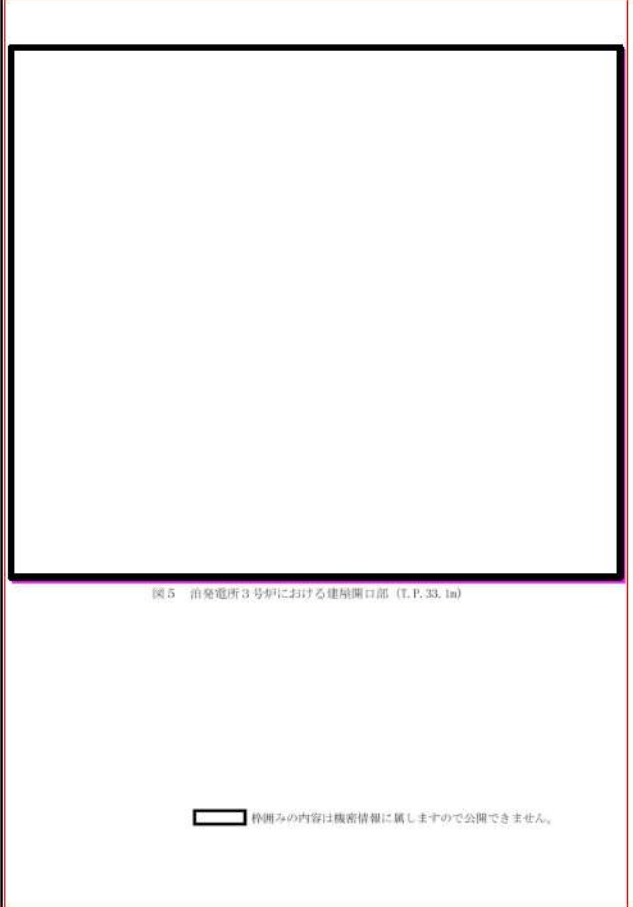

第6条 外部からの衝撃による損傷の防止（竜巻：別添資料1 添付資料3.11）

大飯発電所3/4号炉	女川原子力発電所2号炉	泊発電所3号炉	相違理由
 <p>特開みの範囲は機密に属する事項ですので公開できません。</p> <p>第5図 大飯発電所E.L.+331.6mにおける開口部</p>		 <p>特開みの内容は機密情報に属しますので公開できません。</p> <p>図5 泊発電所3号炉における建屋開口部 (T.P.33.1m)</p>	<p>【大飯】 建屋開口部の相違 ・プラント設計の相違</p>

赤字：設備、運用又は体制の相違（設計方針の相違）
 青字：記載箇所又は記載内容の相違（記載方針の相違）
 緑字：記載表現、設備名称の相違（実質的な相違なし）

大飯発電所3/4号炉	女川原子力発電所2号炉	泊発電所3号炉	相違理由
<div data-bbox="85 248 591 1114" style="border: 1px solid black; width: 100%; height: 100%;"></div> <div data-bbox="586 466 607 924" style="writing-mode: vertical-rl; position: absolute; left: 262px; top: 292px;"> 第6図 大飯発電所E.L. +33.6mにおける開口部の屋内写真(2/11) </div> <div data-bbox="651 240 678 735" style="border: 1px solid black; position: absolute; left: 291px; top: 151px; width: 100%; height: 100%;"> 枠囲みの範囲は機密に属する事項ですので公開できません。 </div>		<div data-bbox="1350 225 1953 986" style="border: 1px solid red; padding: 5px;">  </div> <div data-bbox="1350 1123 1861 1166" style="margin-top: 10px;"> <p>図6 泊発電所3号炉における建屋開口部周辺の屋内写真他（T.P.33.1m）（2/3）</p> <p style="border: 1px solid black; display: inline-block; padding: 2px;">枠囲みの内容は機密情報に属しますので公開できません。</p> </div>	<p>【大飯】</p> <p>建屋開口部の相違 設備配置の相違 ・プラント設計の相違</p>

赤字：設備、運用又は体制の相違（設計方針の相違）
 青字：記載箇所又は記載内容の相違（記載方針の相違）
 緑字：記載表現、設備名称の相違（実質的な相違なし）

大飯発電所3/4号炉	女川原子力発電所2号炉	泊発電所3号炉	相違理由
<div data-bbox="85 220 600 1117" style="border: 1px solid black; width: 100%; height: 100%;"></div> <div data-bbox="600 459 622 925" style="writing-mode: vertical-rl; position: absolute; left: 268px; top: 288px;"> 第6図 大飯発電所E.L. 35.6mにおける開口部の屋内外写真(3/11) </div> <div data-bbox="656 236 685 742" style="border: 1px solid black; writing-mode: vertical-rl; position: absolute; left: 293px; top: 148px;"> 物置の開口は機密に係る事項ですの公開することはできません。 </div>		<div data-bbox="1350 220 1953 1273" style="border: 1px solid red; padding: 5px;"> <p style="text-align: center;">当該開口部を背にして屋内を撮影</p>  <p style="text-align: center;">建屋外側（隣接建屋内）から当該開口部を撮影</p>  <p style="font-size: small;">当該開口部（ブローアウトパネル）を貫通した設計機来物が外部事象防護対象施設である主蒸気系統配管他に衝突しないよう、当該開口部に防護鋼板を設置する。</p> <p style="text-align: center;">図6 泊発電所3号炉における建屋開口部周辺の屋内写真他（T.P. 33. 1m）（3/3）</p> </div>	<p>【大飯】 建屋開口部の相違 設備配置の相違 ・プラント設計の相違</p>

赤字：設備、運用又は体制の相違（設計方針の相違）
 青字：記載箇所又は記載内容の相違（記載方針の相違）
 緑字：記載表現、設備名称の相違（実質的な相違なし）

第6条 外部からの衝撃による損傷の防止（竜巻：別添資料1 添付資料3.11）

大飯発電所3/4号炉	女川原子力発電所2号炉	泊発電所3号炉	相違理由
<div data-bbox="85 252 600 1145" style="border: 2px solid black; width: 100%; height: 100%;"></div> <div data-bbox="600 475 622 954" style="writing-mode: vertical-rl; text-orientation: upright; font-size: small;"> 第6図 大飯発電所E.L.433.6mにおける開口部の取付内外写真(4/11) </div> <div data-bbox="658 252 680 762" style="border: 1px solid black; padding: 2px; font-size: x-small;"> 特開みの説明は機密に係る事項ですので公開することはありません。 </div>			<p>【大飯】</p> <ul style="list-style-type: none"> 建屋開口部の相違 設備配置の相違 ・プラント設計の相違

赤字：設備、運用又は体制の相違（設計方針の相違）
 青字：記載箇所又は記載内容の相違（記載方針の相違）
 緑字：記載表現、設備名称の相違（実質的な相違なし）

第6条 外部からの衝撃による損傷の防止（竜巻：別添資料1 添付資料3.11）

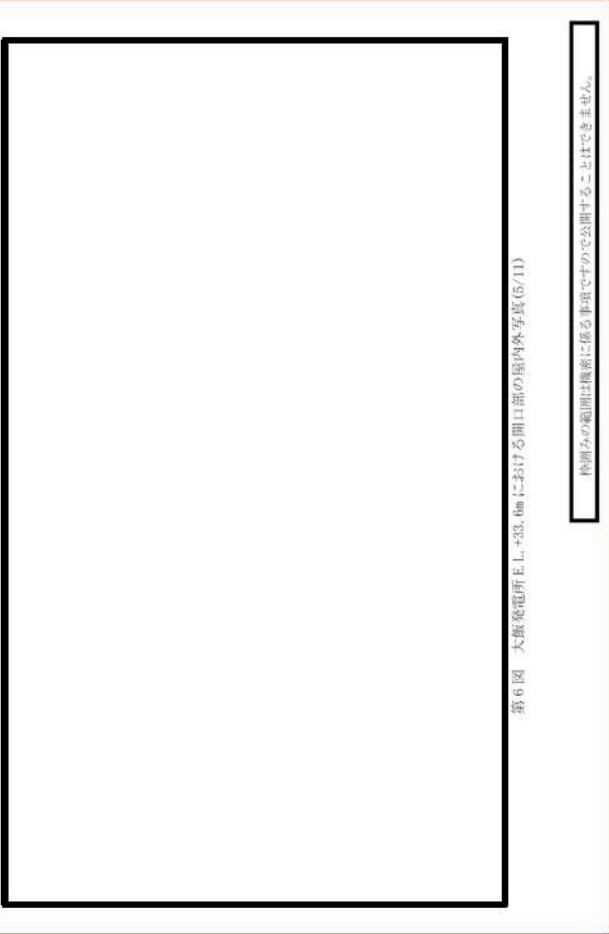
大飯発電所3/4号炉	女川原子力発電所2号炉	泊発電所3号炉	相違理由
 <p data-bbox="591 488 613 948">第6図 大飯発電所E.L.+33.0mにおける開口部の屋内外写真(5/11)</p> <p data-bbox="658 252 680 751">図面との差別に係る事項ですので公開することはありません。</p>			<p data-bbox="1980 233 2040 252">【大飯】</p> <p data-bbox="1980 261 2114 280">建屋開口部の相違</p> <p data-bbox="1980 290 2092 309">設備配置の相違</p> <p data-bbox="1980 319 2148 338">・プラント設計の相違</p>

赤字：設備、運用又は体制の相違（設計方針の相違）
 青字：記載箇所又は記載内容の相違（記載方針の相違）
 緑字：記載表現、設備名称の相違（実質的な相違なし）

第6条 外部からの衝撃による損傷の防止（竜巻：別添資料1 添付資料3.11）

大飯発電所3/4号炉	女川原子力発電所2号炉	泊発電所3号炉	相違理由
<div data-bbox="85 247 607 1145" style="border: 2px solid black; width: 100%; height: 100%;"></div> <div data-bbox="600 475 629 954" style="text-align: center;"> 第6図 大飯発電所E.L.+33.6mにおける開口部の境内外写真(6/11) </div> <div data-bbox="656 247 685 758" style="border: 1px solid black; padding: 2px;"> 枠組みの範囲は概算に係る事項ですので公開することではありません。 </div>			<p>【大飯】</p> <ul style="list-style-type: none"> 建屋開口部の相違 設備配置の相違 ・プラント設計の相違

赤字：設備、運用又は体制の相違（設計方針の相違）
 青字：記載箇所又は記載内容の相違（記載方針の相違）
 緑字：記載表現、設備名称の相違（実質的な相違なし）

第6条 外部からの衝撃による損傷の防止（竜巻：別添資料1 添付資料3.11）

大飯発電所3/4号炉	女川原子力発電所2号炉	泊発電所3号炉	相違理由
<div data-bbox="85 240 598 1118" style="border: 2px solid black; width: 100%; height: 100%;"></div> <div data-bbox="598 464 618 930" style="font-size: small; text-align: center;"> 第6図 大飯発電所E.L.+83.4mにおける開口部の屋内外等長(7/11) </div> <div data-bbox="651 292 678 703" style="border: 1px solid black; padding: 2px; font-size: x-small;"> 作図みの範囲は機密に係る事項ですので公開することはありません。 </div>			<p>【大飯】</p> <ul style="list-style-type: none"> 建屋開口部の相違 設備配置の相違 ・プラント設計の相違

赤字：設備、運用又は体制の相違（設計方針の相違）
 青字：記載箇所又は記載内容の相違（記載方針の相違）
 緑字：記載表現、設備名称の相違（実質的な相違なし）

第6条 外部からの衝撃による損傷の防止（竜巻：別添資料1 添付資料3.11）

大飯発電所3/4号炉	女川原子力発電所2号炉	泊発電所3号炉	相違理由
<div data-bbox="85 247 607 1145" style="border: 2px solid black; width: 100%; height: 100%;"></div> <div data-bbox="600 475 629 951" style="text-align: center;"> 第6図 大飯発電所L.L.+33.6mにおける開口部の屋内外写真(8/11) </div> <div data-bbox="651 316 680 735" style="border: 1px solid black; padding: 2px; text-align: center;"> 枠組みの範囲は撮影に係る事項ですので公開することはありません。 </div>			<p>【大飯】</p> <ul style="list-style-type: none"> 建屋開口部の相違 設備配置の相違 ・プラント設計の相違

赤字：設備、運用又は体制の相違（設計方針の相違）
 青字：記載箇所又は記載内容の相違（記載方針の相違）
 緑字：記載表現、設備名称の相違（実質的な相違なし）

第6条 外部からの衝撃による損傷の防止（竜巻：別添資料1 添付資料3.11）

大飯発電所3/4号炉	女川原子力発電所2号炉	泊発電所3号炉	相違理由
<div data-bbox="94 252 595 1118" style="border: 2px solid black; width: 100%; height: 100%;"></div> <div data-bbox="595 469 618 927" style="font-size: small; text-align: center;"> 第6図 大飯発電所L.L.+33.6mにおける開口部の屋内外写真(9/11) </div> <div data-bbox="658 261 680 762" style="border: 1px solid black; padding: 2px; font-size: x-small;"> 特開みの範囲は機密に係る事項ですので公開することはできません。 </div>			<p>【大飯】</p> <ul style="list-style-type: none"> 建屋開口部の相違 設備配置の相違 ・プラント設計の相違

赤字：設備、運用又は体制の相違（設計方針の相違）
 青字：記載箇所又は記載内容の相違（記載方針の相違）
 緑字：記載表現、設備名称の相違（実質的な相違なし）

第6条 外部からの衝撃による損傷の防止（竜巻：別添資料1 添付資料3.11）

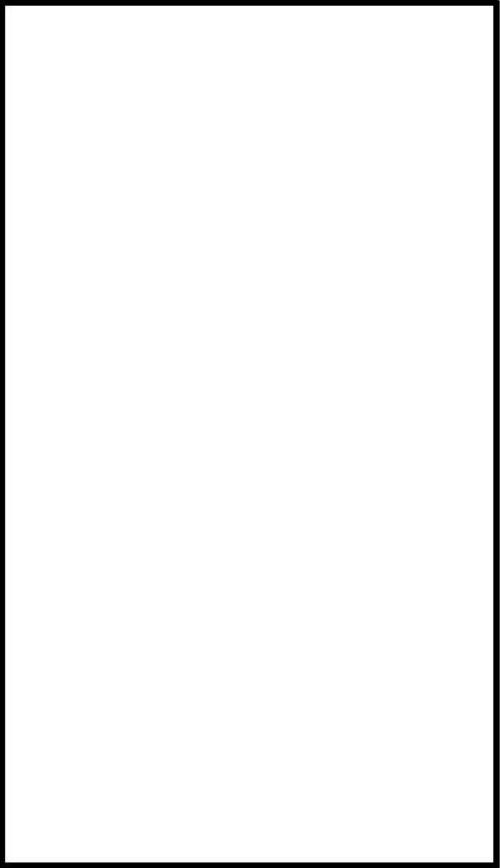
大飯発電所3/4号炉	女川原子力発電所2号炉	泊発電所3号炉	相違理由
<div data-bbox="85 226 689 1161" style="border: 1px solid black; padding: 10px;">  <p style="text-align: center;">第6図 大飯発電所E.L.+33.6mにおける開口部の屋内外写真(10/11)</p> <p style="text-align: center;">※図面の範囲は機密に係る事項ですので公開することはありません。</p> </div>			<p>【大飯】</p> <ul style="list-style-type: none"> 建屋開口部の相違 設備配置の相違 ・プラント設計の相違

赤字：設備、運用又は体制の相違（設計方針の相違）
 青字：記載箇所又は記載内容の相違（記載方針の相違）
 緑字：記載表現、設備名称の相違（実質的な相違なし）

第6条 外部からの衝撃による損傷の防止（竜巻：別添資料1 添付資料3.11）

大飯発電所3/4号炉	女川原子力発電所2号炉	泊発電所3号炉	相違理由
<div data-bbox="85 276 282 1161" style="border: 2px solid black; width: 88px; height: 555px; margin-bottom: 10px;"></div> <div data-bbox="280 493 309 975" style="display: inline-block; text-align: center;"> 第6図 大飯発電所E.L.+33.6mにおける開口部の屋内外写真(11/11) </div> <div data-bbox="651 245 680 754" style="border: 1px solid black; padding: 2px; width: 13px; height: 319px; margin-left: 255px;"> 枠囲みの範囲は機室に属する事項ですので公開することはありません。 </div>			<p>【大飯】</p> <ul style="list-style-type: none"> 建屋開口部の相違 設備配置の相違 ・プラント設計の相違

赤字：設備、運用又は体制の相違（設計方針の相違）
 青字：記載箇所又は記載内容の相違（記載方針の相違）
 緑字：記載表現、設備名称の相違（実質的な相違なし）

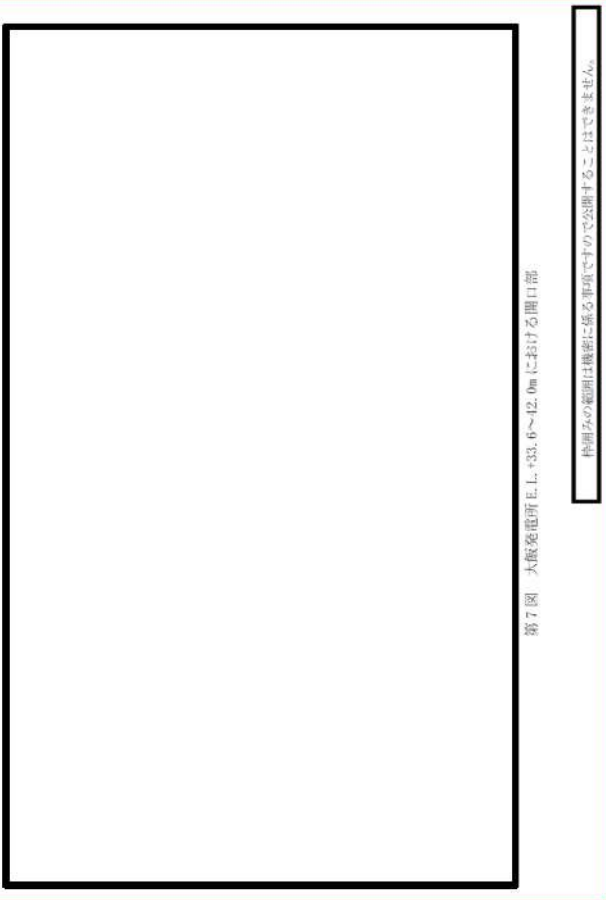
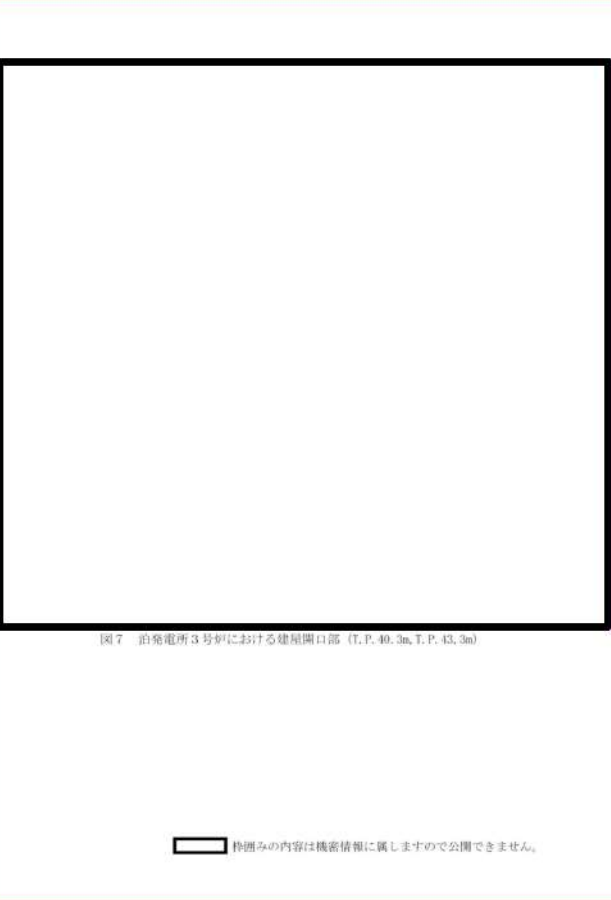
大飯発電所3/4号炉	女川原子力発電所2号炉	泊発電所3号炉	相違理由
 <p>第7図 大飯発電所E.L.+33.6~42.0mにおける開口部</p> <p>特開みの範囲は機密に属する事項ですので公開できません。</p>		 <p>図7 泊発電所3号炉における建屋開口部 (T.P.40.3m,T.P.43.3m)</p> <p>特開みの内容は機密情報に属しますので公開できません。</p>	<p>【大飯】 建屋開口部の相違 ・プラント設計の相違</p>

赤字：設備、運用又は体制の相違（設計方針の相違）
 青字：記載箇所又は記載内容の相違（記載方針の相違）
 緑字：記載表現、設備名称の相違（実質的な相違なし）

大飯発電所3/4号炉	女川原子力発電所2号炉	泊発電所3号炉	相違理由
<div data-bbox="85 260 591 1134" style="border: 1px solid black; width: 100%; height: 100%;"></div> <div data-bbox="586 481 611 933" style="writing-mode: vertical-rl; position: absolute; right: 10px; top: 50%; transform: translateY(-50%);"> 第8図 大飯発電所E.L.+33.6~42.0mにおける開口部の屋内写真 </div> <div data-bbox="658 300 683 703" style="writing-mode: vertical-rl; position: absolute; right: 10px; top: 150px;"> 枠組みの範囲は概略に示す事項でしか公開することはできません。 </div>		<div data-bbox="1352 268 1951 831" style="border: 1px solid red; padding: 5px;">  <p>屋内から当該開口部を撮影</p> <p>当該開口部を覆っている格納容器排気系統用外気取入ガラリフードを貫通した設計飛来物が外部事象防護対象施設である排気筒（建屋内）他に衝突しないよう、当該開口部に防護鋼板を設置する。</p> <p>建屋開口部前</p> <p>建屋開口部前（屋外から撮影）</p> <p>ガラリ（タービン建屋屋上）</p> <p>ガラリ内</p> <p>建屋開口部前（屋外から撮影）</p> <p>建屋開口部前</p> <p>原子が建屋に隣接しているタービン建屋屋上のガラリを貫通した設計飛来物が外部事象防護対象施設である主蒸気系統配管他に衝突しないよう、当該開口部（換気口）に防護鋼板を設置する。</p> </div> <p>図8 泊発電所3号炉における建屋開口部周辺の屋内写真他（T.P.40.3m,T.P.43.3m）</p>	<p>【大飯】</p> <p>建屋開口部の相違</p> <p>設備配置の相違</p> <p>・プラント設計の相違</p>

赤字：設備、運用又は体制の相違（設計方針の相違）
 青字：記載箇所又は記載内容の相違（記載方針の相違）
 緑字：記載表現、設備名称の相違（実質的な相違なし）

第6条 外部からの衝撃による損傷の防止（竜巻：別添資料1 添付資料3.11）

大飯発電所3/4号炉	女川原子力発電所2号炉	泊発電所3号炉	相違理由
<div data-bbox="85 252 600 1120" style="border: 2px solid black; width: 100%; height: 100%;"></div> <div data-bbox="600 496 629 879" style="text-align: center;"> 第9図 大飯発電所E.L.+39.85～+42.0mにおける開口部 </div> <div data-bbox="658 284 680 699" style="border: 1px solid black; padding: 2px; text-align: center;"> 内開きの範囲は図面に係る事項ですので公開することはできません。 </div>			<p>【大飯】</p> <ul style="list-style-type: none"> 建屋開口部の相違 設備配置の相違 ・プラント設計の相違

赤字：設備、運用又は体制の相違（設計方針の相違）
 青字：記載箇所又は記載内容の相違（記載方針の相違）
 緑字：記載表現、設備名称の相違（実質的な相違なし）

第6条 外部からの衝撃による損傷の防止（竜巻：別添資料1 添付資料3.11）

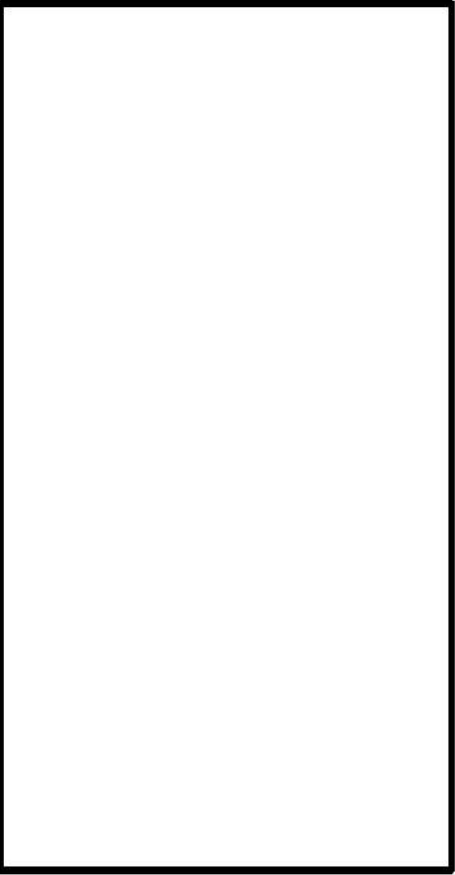
大飯発電所3/4号炉	女川原子力発電所2号炉	泊発電所3号炉	相違理由
<div data-bbox="85 229 689 1158" style="border: 1px solid black; padding: 10px;">  <p style="text-align: center; margin-top: 10px;">第10図 大飯発電所E.L.+39.85~42.0mにおける開口部の屋内写真</p> <p style="text-align: center; font-size: small;">※図面の範囲は撮影に係る事項ですので公開することはできません。</p> </div>			<p>【大飯】</p> <ul style="list-style-type: none"> 建屋開口部の相違 設備配置の相違 ・プラント設計の相違

赤字：設備、運用又は体制の相違（設計方針の相違）
 青字：記載箇所又は記載内容の相違（記載方針の相違）
 緑字：記載表現、設備名称の相違（実質的な相違なし）

第6条 外部からの衝撃による損傷の防止（竜巻：別添資料1 添付資料3.11）

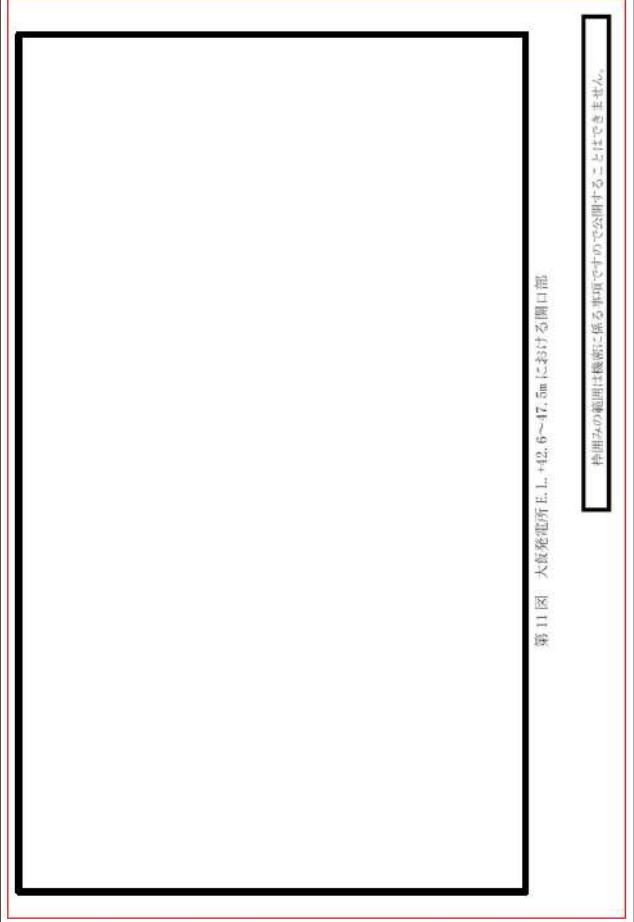
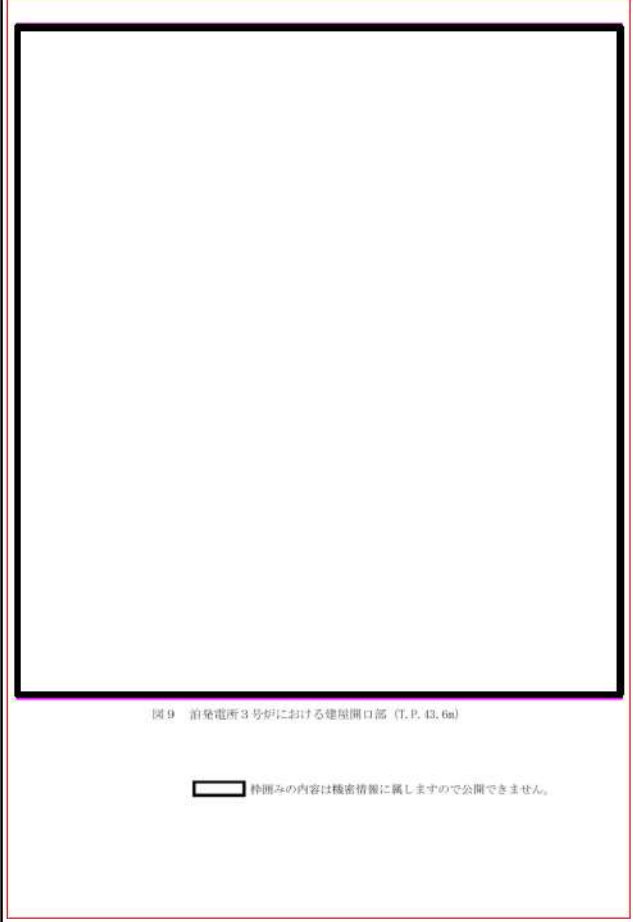
大飯発電所3/4号炉	女川原子力発電所2号炉	泊発電所3号炉	相違理由
 <p data-bbox="600 507 622 890">第11図 大飯発電所上上、+42.6～+47.5mにおける開口部</p>		 <p data-bbox="1482 944 1796 960">図9 泊発電所3号炉における建屋開口部 (T.P. 43.6m)</p> <p data-bbox="1527 1018 1886 1034">特開みの内容は機密情報に属しますので公開できません。</p>	<p data-bbox="1975 236 2154 316">【大飯】 建屋開口部の相違 ・プラント設計の相違</p>

赤字：設備、運用又は体制の相違（設計方針の相違）
 青字：記載箇所又は記載内容の相違（記載方針の相違）
 緑字：記載表現、設備名称の相違（実質的な相違なし）

第6条 外部からの衝撃による損傷の防止（竜巻：別添資料1 添付資料3.11）

大飯発電所3/4号炉	女川原子力発電所2号炉	泊発電所3号炉	相違理由
<div data-bbox="85 226 584 1118" style="border: 1px solid black; width: 100%; height: 100%;"></div> <div data-bbox="584 456 607 943" style="position: absolute; left: 261px; top: 286px; font-size: small;">第12図 大飯発電所E.L.+2.6~47.5mにおける開口部の屋内写真(1/2)</div> <div data-bbox="651 236 680 730" style="position: absolute; left: 291px; top: 148px; border: 1px solid black; padding: 2px; font-size: x-small;">内周みの範囲は撮影はできません。</div>		<div data-bbox="1346 226 1955 485" style="border: 1px solid black; padding: 5px;">  <div data-bbox="1512 245 1630 268" style="border: 1px solid black; padding: 2px; font-size: x-small;">建屋開口部①</div> <div data-bbox="1711 284 1944 405" style="border: 1px solid red; padding: 5px; color: red; font-size: x-small;">当該開口部を貫通した設計飛来物が外部事象防護対象施設である原子炉補機冷却水サージタンク他に衝突しないよう、当該開口部近傍（建屋内）にコンクリート製の防護壁を設置する。</div> <div data-bbox="1355 464 1570 485" style="border: 1px solid black; padding: 2px; font-size: x-small;">当該開口部を背にして屋内を撮影</div> </div> <div data-bbox="1361 1241 1928 1262" style="font-size: x-small;">図10 泊発電所3号炉における建屋開口部周辺の屋内写真他（T.P. 43, 6m）</div>	<p>【大飯】 建屋開口部の相違 設備配置の相違 ・プラント設計の相違</p>

赤字：設備、運用又は体制の相違（設計方針の相違）
 青字：記載箇所又は記載内容の相違（記載方針の相違）
 緑字：記載表現、設備名称の相違（実質的な相違なし）

第6条 外部からの衝撃による損傷の防止（竜巻：別添資料1 添付資料3.11）

大飯発電所3/4号炉	女川原子力発電所2号炉	泊発電所3号炉	相違理由
<div data-bbox="85 252 436 1120" style="border: 2px solid black; width: 157px; height: 544px; margin-bottom: 10px;"></div> <div data-bbox="432 453 459 944" style="font-size: 8px; text-align: center;"> 第12図 大飯発電所主上・中・下層における開口部の屋内写真(2/2) </div> <div data-bbox="651 236 678 734" style="border: 1px solid black; padding: 2px; font-size: 8px; text-align: center;"> 特記の範囲は掲載に係る事項ですので公開することはありません。 </div>			<p>【大飯】</p> <ul style="list-style-type: none"> 建屋開口部の相違 設備配置の相違 ・プラント設計の相違

赤字：設備、運用又は体制の相違（設計方針の相違）
 青字：記載箇所又は記載内容の相違（記載方針の相違）
 緑字：記載表現、設備名称の相違（実質的な相違なし）

第6条 外部からの衝撃による損傷の防止（竜巻：別添資料1 添付資料3.11）

大飯発電所3/4号炉	女川原子力発電所2号炉	泊発電所3号炉	相違理由
<p style="text-align: right;">別紙 1</p> <p>障害物と竜巻防護施設の位置関係の調査結果について</p> <p>【開口部 No.2（4号電動補助給水ポンプ室）について】</p> <p>①断面に関する検討</p> <p>最も侵入角が厳しい場合を想定し、永久構台天板から設計飛来物が侵入したと仮定した場合、飛来物の開口部内部への侵入距離は1.1mである。一方、水密扉から、電動補助給水ポンプまでの距離は、6.19m、水密扉から電動補助給水ポンプ起動盤までの距離は3.2mであることから設計飛来物は電動補助給水ポンプに衝突しないといえる。</p> <p>各構造物と離隔距離の関係を図1に示す。</p> <div data-bbox="80 643 689 1005" style="border: 1px solid black; height: 200px; width: 100%;"></div> <p style="text-align: center; font-size: small;">図1 飛来物の侵入角と開口部からの離隔距離の関係（電動補助給水ポンプ室）</p> <p>②平面に関する検討</p> <p>電動補助給水ポンプ室の水密扉を貫通した場合の飛来物侵入エリアについて、永久構台南側のコンクリートよう壁において、最も高さが高い位置からの補助給水ポンプ質水密扉への侵入角について検討を行った結果、侵入するエリアにおいて竜巻防護施設がないことを確認した。</p> <p>永久構台南側のコンクリートよう壁、永久構台南端の柱と飛来物侵入エリアの関係を図2に示す。</p>			<p>【大飯】</p> <p>設計方針の相違</p> <p>・泊では、設計飛来物の侵入方向に後背斜面があり、侵入角度が斜め下向きとなるため、対象となる開口部から離れた場所に設置されている外部事象防護対象施設に衝突することは考え難いと評価している箇所が1箇所あるが、図5にその旨記載するとともに、図6(2/3)に当該開口部から撮影した後背斜面の写真を掲載している。</p>

赤字：設備、運用又は体制の相違（設計方針の相違）
 青字：記載箇所又は記載内容の相違（記載方針の相違）
 緑字：記載表現、設備名称の相違（実質的な相違なし）

第6条 外部からの衝撃による損傷の防止（竜巻：別添資料1 添付資料3.11）

大飯発電所3/4号炉	女川原子力発電所2号炉	泊発電所3号炉	相違理由
<div data-bbox="80 233 654 906" style="border: 2px solid black; height: 422px; width: 256px; margin-bottom: 10px;"></div> <div data-bbox="145 906 586 922" style="font-size: small;">図2 4号電動補助給水ポンプ室の水密扉への飛来物衝突に係る侵入エリア</div> <div data-bbox="203 938 685 962" style="border: 1px solid black; padding: 2px; font-size: x-small;">枠囲み範囲は機密に係る事項ですので、公開することはできません</div> <p data-bbox="80 1015 539 1038">【開口部 No. 3, 12（ディーゼル発電機室）について】</p> <p data-bbox="80 1046 696 1214">4A ディーゼル発電機室及び3B ディーゼル発電機室の飛来物侵入エリアについて、現地確認を行った結果を以下に示す。現地確認を行った結果、防護対象であるディーゼル発電機の付属設備である電源ケーブル及び空気だめ等が設置されていることを確認した。4A ディーゼル発電機室及び3B ディーゼル発電機室の調査結果をそれぞれ、図3及び図4に示す。</p> <p data-bbox="80 1222 696 1334">上記調査結果より、ディーゼル発電機水密扉に防護機能を期待することになるため、開口部であるディーゼル発電機室の水密扉に対し、設計飛来物を衝突させた結果、貫通阻止できることを確認した。この貫通評価結果を別紙2に示す。</p>			

赤字：設備，運用又は体制の相違（設計方針の相違）
 青字：記載箇所又は記載内容の相違（記載方針の相違）
 緑字：記載表現，設備名称の相違（実質的な相違なし）

第6条 外部からの衝撃による損傷の防止（竜巻：別添資料1 添付資料3.11）

大飯発電所3/4号炉	女川原子力発電所2号炉	泊発電所3号炉	相違理由
<div data-bbox="85 236 654 762" style="border: 2px solid black; width: 100%; height: 100%;"></div> <p data-bbox="224 766 504 790">図3 開口部3の飛来物侵入エリアについて</p> <div data-bbox="219 849 685 880" style="border: 1px solid black; padding: 2px; width: fit-content; margin: 10px auto;"> <p>枠囲み範囲は機密に係る事項ですので、公開することはできません</p> </div>			

赤字：設備、運用又は体制の相違（設計方針の相違）
 青字：記載箇所又は記載内容の相違（記載方針の相違）
 緑字：記載表現、設備名称の相違（実質的な相違なし）

第6条 外部からの衝撃による損傷の防止（竜巻：別添資料1 添付資料3.11）

大飯発電所3/4号炉	女川原子力発電所2号炉	泊発電所3号炉	相違理由
<div data-bbox="85 231 645 778" style="border: 2px solid black; width: 250px; height: 343px; margin-bottom: 10px;"></div> <p data-bbox="219 778 506 798">図4 開口部12の飛来物侵入エリアについて</p> <div data-bbox="219 1023 680 1050" style="border: 1px solid black; padding: 2px; margin-top: 10px;"> <p data-bbox="232 1027 667 1045">枠囲み範囲は機密に係る事項ですので、公開することはできません</p> </div> <p data-bbox="85 1102 651 1125">【開口部No.4,5,10,11（ディーゼル発電機制御盤室）について】</p> <p data-bbox="73 1134 271 1157">① 断面に関する検討</p> <p data-bbox="73 1161 696 1300">最も侵入角が厳しい場合を想定し、タービン建屋屋上から設計飛来物が侵入したと仮定した場合、飛来物の開口部内部への侵入距離は2.26mである。一方、水密扉から、ディーゼル発電機制御盤までの距離は、2.46mであることから設計飛来物はディーゼル発電機制御盤に直接、衝突する侵入角にないことを確認している。</p> <p data-bbox="73 1305 696 1417">また、当該制御盤室の水密扉はディーゼル発電機室水密扉と同様、厚み11mm（表板9mm+裏板2mm、材質SUS304）であり、設計飛来物は貫通せず、飛来物がディーゼル発電機制御盤に影響を与えないことを確認している。</p> <p data-bbox="96 1422 551 1444">各構造物と離隔距離の関係は図5のとおりである。</p>			

赤字：設備、運用又は体制の相違（設計方針の相違）
 青字：記載箇所又は記載内容の相違（記載方針の相違）
 緑字：記載表現、設備名称の相違（実質的な相違なし）

第6条 外部からの衝撃による損傷の防止（竜巻：別添資料1 添付資料3.11）

大飯発電所3/4号炉	女川原子力発電所2号炉	泊発電所3号炉	相違理由
<div data-bbox="85 225 645 715" data-label="Image"> </div> <div data-bbox="114 715 595 735" data-label="Caption"> <p>図5 飛来物の侵入角と開口部からの距離距離の関係（ディーゼル発電機制御盤室）</p> </div> <div data-bbox="203 858 689 890" data-label="Text"> <p>枠囲み範囲は機密に係る事項ですので、公開することはできません</p> </div> <div data-bbox="73 927 703 1070" data-label="Text"> <p>②平面に関する検討 ディーゼル発電機制御盤室の水密扉を貫通した場合の飛来物侵入エリアについて、検討した結果、飛来物の室内への侵入がないことを確認した。 タービン建屋と飛来物侵入角の関係を図6に示す。</p> </div>			

赤字：設備、運用又は体制の相違（設計方針の相違）
 青字：記載箇所又は記載内容の相違（記載方針の相違）
 緑字：記載表現、設備名称の相違（実質的な相違なし）

第6条 外部からの衝撃による損傷の防止（竜巻：別添資料1 添付資料3.11）

大飯発電所 3 / 4号炉	女川原子力発電所 2号炉	泊発電所 3号炉	相違理由
<div data-bbox="85 229 658 434" style="border: 2px solid black; width: 256px; height: 128px; margin-bottom: 10px;"></div> <p data-bbox="188 438 560 454">図6 飛来物の侵入角と開口部の関係（ディーゼル発電機制御室）</p> <div data-bbox="226 914 685 935" style="border: 1px solid black; padding: 2px; margin-top: 10px;"> <p>枠囲み範囲は機密に係る事項ですので、公開することはできません</p> </div> <p data-bbox="85 986 533 1010">【開口部 No. 6, 9（ディーゼル発電機室）について】</p> <p data-bbox="73 1015 264 1038">①断面に関する検討</p> <p data-bbox="73 1043 696 1182">最も侵入角が厳しい場合を想定し、タービン建屋屋上から設計飛来物が侵入したと仮定した場合、飛来物の開口部内部への侵入距離は4.53mである。一方、水密扉から、ディーゼル発電機までの距離は、6.62mであることから設計飛来物はディーゼル発電機に衝突しないといえる。</p> <p data-bbox="96 1187 472 1211">各構造物と離隔距離の関係を図7に示す。</p>			

赤字：設備，運用又は体制の相違（設計方針の相違）
 青字：記載箇所又は記載内容の相違（記載方針の相違）
 緑字：記載表現，設備名称の相違（実質的な相違なし）

第6条 外部からの衝撃による損傷の防止（竜巻：別添資料1 添付資料3.11）

大飯発電所3/4号炉	女川原子力発電所2号炉	泊発電所3号炉	相違理由
<div data-bbox="85 231 674 746" data-label="Image"> </div> <div data-bbox="145 751 616 770" data-label="Caption"> <p>図7 飛来物の侵入角と開口部からの離隔距離の関係（ディーゼル発電機室）</p> </div> <div data-bbox="197 1002 667 1021" data-label="Text"> <p>枠囲み範囲は機密に係る事項ですので、公開することはできません</p> </div> <div data-bbox="71 1074 703 1185" data-label="Text"> <p>②平面に関する検討 ディーゼル発電機の水密扉を貫通した場合の飛来物侵入エリアについて、検討した結果、飛来物の室内への侵入がないことを確認した。 タービン建屋と飛来物侵入角の関係を図8に示す。</p> </div>			

赤字：設備，運用又は体制の相違（設計方針の相違）
 青字：記載箇所又は記載内容の相違（記載方針の相違）
 緑字：記載表現，設備名称の相違（実質的な相違なし）

第6条 外部からの衝撃による損傷の防止（竜巻：別添資料1 添付資料3.11）

大飯発電所3/4号炉	女川原子力発電所2号炉	泊発電所3号炉	相違理由
<div data-bbox="85 229 672 427" style="border: 2px solid black; width: 262px; height: 124px; margin-bottom: 10px;"></div> <div data-bbox="197 432 544 456" style="font-size: small;">図8 飛来物の侵入角と開口部の関係（ディーゼル発電機室）</div> <div data-bbox="219 948 685 975" style="border: 1px solid black; padding: 2px; margin-top: 400px; font-size: x-small;">枠囲み範囲は機密に係る事項ですので、公開することはできません</div>			

赤字：設備、運用又は体制の相違（設計方針の相違）
 青字：記載箇所又は記載内容の相違（記載方針の相違）
 緑字：記載表現、設備名称の相違（実質的な相違なし）

第6条 外部からの衝撃による損傷の防止（竜巻：別添資料1 添付資料3.11）

大阪発電所3/4号炉	女川原子力発電所2号炉	泊発電所3号炉	相違理由
<p style="text-align: right;">別紙2</p> <p style="text-align: center;">ディーゼル発電機室の水密扉への飛来物貫通評価について</p> <p>1. 概要</p> <p>ディーゼル発電機室の水密扉について、設計飛来物の衝突により貫通した場合に飛来物がディーゼル発電機の付属設備に衝突する可能性を否定できないことから、ディーゼル発電機室水密扉に対して竜巻防護施設を内包する施設としての健全性を確認するために設計飛来物の貫通評価を行い、貫通有無の確認を行った。</p> <p>なお、水密扉の倒壊に対する影響については、水密扉の高さと竜巻防護施設の離隔距離より、水密扉が倒壊したとしても竜巻防護施設に衝突しないことは確認している。</p> <p>2. 評価方針</p> <p>ディーゼル発電機室水密扉への貫通評価については、鋼製構造物に対する既往の貫通評価式であるBRL式の適用性について検討を行った電中研成果「竜巻飛来物を模擬した重錘の鋼板上への自由落下衝突試験による鋼板貫通評価手法の提案」における知見を用い、BRL式にて評価することとする。BRL式による評価を4章に記載する。</p> <p>また、上記の電中研成果を用いたBRL式による貫通評価に加え、設計飛来物及びディーゼル発電機室水密扉を3次元FEMにてモデル化を行いLS-DYNA Version R7.1.2を用いた衝突解析を実施することとする。なお、衝突解析における各種設定については、同報告書により実験との整合性を確認したものと同様とした。3次元FEMモデルを用いた飛来物衝突解析における評価を5章に記載する。</p> <p>これらのディーゼル発電機室水密扉の貫通評価の評価フローを第2-1図に示す。</p> <div data-bbox="80 1070 692 1473" style="border: 1px solid black; padding: 5px;"> <pre> graph TD A[ディーゼル発電機室水密扉の貫通評価] --> B[鋼製構造物に対する既往の貫通評価式 (BRL式)における貫通評価 (4章)] A --> C[3次元 FEM モデルを用いた飛来物 衝突解析における評価 (5章)] B --> D[ディーゼル発電機室水密扉の 貫通有無の確認] C --> D D --> E[検討終了] </pre> <p style="text-align: center;">第2-1図 ディーゼル発電機室水密扉の貫通評価フロー</p> </div>			<p>【大阪】</p> <p>設計方針の相違</p> <ul style="list-style-type: none"> 大阪では、既存水密扉に対して貫通評価を行い、貫通しないことを確認した結果を別紙2に記載しているが、泊では、対象となる扉はないため、記載していない。

赤字：設備、運用又は体制の相違（設計方針の相違）
 青字：記載箇所又は記載内容の相違（記載方針の相違）
 緑字：記載表現、設備名称の相違（実質的な相違なし）

第6条 外部からの衝撃による損傷の防止（竜巻：別添資料1 添付資料3.11）

大飯発電所3/4号炉	女川原子力発電所2号炉	泊発電所3号炉	相違理由
<p>3. ディーゼル発電機室水密扉の構造概要及び仕様</p> <p>ディーゼル発電機室の水密扉は表板、チャンネル鋼、裏板、フレーム、カンヌキ、ヒンジ、操作ハンドル、アンカーボルト等にて構成し、外部に面する表板及び扉部材に作用する荷重をアンカーボルトにより固定されたフレームを介して周辺躯体である鉄筋コンクリート造の壁（以下「外壁」という。）で支持する構造である。また、水密扉の構造概要を第3-1図、仕様を第3-1表に示す。</p> <div data-bbox="85 448 685 868" style="border: 1px solid black; height: 263px; width: 268px; margin: 10px 0;"></div> <p style="text-align: center; font-size: small;">第3-1図 ディーゼル発電機室水密扉の構造概要</p> <div data-bbox="85 959 685 1023" style="border: 1px solid black; height: 40px; width: 268px; margin: 10px 0;"></div> <p style="text-align: center; font-size: small;">第3-1表 ディーゼル発電機室水密扉の仕様</p> <p>4. 鋼製構造物に対する既往の評価式における評価方法</p> <p>鋼製構造物に対する既往の評価式(BRL式)における評価については、第4-1図の評価フローにより評価を行う。</p> <div data-bbox="98 1203 672 1246" style="border: 1px solid black; padding: 5px; margin: 10px 0;"> <p style="font-size: x-small;">枠囲みの範囲は機密に係る事項ですので公開することはできません。</p> </div>			

赤字：設備、運用又は体制の相違（設計方針の相違）
 青字：記載箇所又は記載内容の相違（記載方針の相違）
 緑字：記載表現、設備名称の相違（実質的な相違なし）

第6条 外部からの衝撃による損傷の防止（竜巻：別添資料1 添付資料3.11）

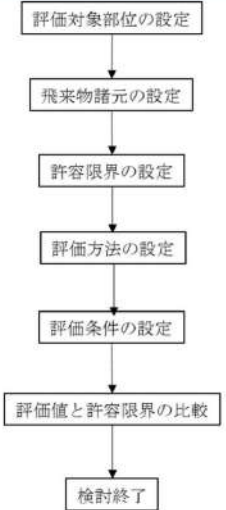
大飯発電所3/4号炉	女川原子力発電所2号炉	泊発電所3号炉	相違理由																		
<div data-bbox="73 228 692 805" style="border: 1px solid black; padding: 5px;">  <p data-bbox="85 769 663 794">第4-1図 鋼製構造物に対する既往の評価式における評価フロー</p> </div> <div data-bbox="73 839 663 922" style="border: 1px solid black; padding: 5px;"> <p data-bbox="73 839 224 865">4.1 記号の定義</p> <p data-bbox="73 868 663 922">鋼製構造物に対する既往の評価式に用いる記号を第4-1表に示す。</p> </div> <div data-bbox="73 957 692 1211" style="border: 1px solid black; padding: 5px;"> <p data-bbox="118 971 663 997">第4-1表 鋼製構造物に対する既往の評価式(BRL式)に用いる記号</p> <table border="1" data-bbox="85 1000 680 1193"> <thead> <tr> <th>記号</th> <th>単位</th> <th>定義</th> </tr> </thead> <tbody> <tr> <td>d</td> <td>m</td> <td>設計飛来物が衝突する衝突断面の等価直径</td> </tr> <tr> <td>K</td> <td>—</td> <td>鋼板の材質に関する係数</td> </tr> <tr> <td>M</td> <td>kg</td> <td>設計飛来物の質量</td> </tr> <tr> <td>T</td> <td>m</td> <td>貫通限界厚さ</td> </tr> <tr> <td>V</td> <td>m/s</td> <td>設計飛来物の最大水平速度</td> </tr> </tbody> </table> </div> <div data-bbox="73 1244 696 1388" style="border: 1px solid black; padding: 5px;"> <p data-bbox="73 1244 241 1270">4.2 評価対象部位</p> <p data-bbox="73 1273 696 1388">鋼製構造物に対する既往の評価式による評価における評価対象部位は、設計飛来物の衝突により、外殻を構成する扉部材が設計飛来物を貫通させないことを確認するため、外殻を構成する扉板を評価対象部位として設定する。</p> </div>	記号	単位	定義	d	m	設計飛来物が衝突する衝突断面の等価直径	K	—	鋼板の材質に関する係数	M	kg	設計飛来物の質量	T	m	貫通限界厚さ	V	m/s	設計飛来物の最大水平速度			
記号	単位	定義																			
d	m	設計飛来物が衝突する衝突断面の等価直径																			
K	—	鋼板の材質に関する係数																			
M	kg	設計飛来物の質量																			
T	m	貫通限界厚さ																			
V	m/s	設計飛来物の最大水平速度																			

赤字：設備、運用又は体制の相違（設計方針の相違）
 青字：記載箇所又は記載内容の相違（記載方針の相違）
 緑字：記載表現、設備名称の相違（実質的な相違なし）

第6条 外部からの衝撃による損傷の防止（竜巻：別添資料1 添付資料3.11）

大飯発電所3/4号炉	女川原子力発電所2号炉	泊発電所3号炉	相違理由																			
<p>4.3 荷重及び荷重の組合せ</p> <p>鋼製構造物に対する既往の評価式による評価において考慮する荷重は、第4-2表に示す設計飛来物の衝突に伴う荷重とし、荷重の組合せを第4-3表に示す。</p> <div data-bbox="73 368 694 691" style="border: 1px solid black; padding: 5px;"> <p style="text-align: center;">第4-2表 設計飛来物の諸元</p> <table border="1" style="width: 100%; border-collapse: collapse;"> <thead> <tr> <th>設計飛来物</th> <th>長さ×幅×奥行き (m)</th> <th>質量 (kg)</th> <th>最大水平速度 (m/s)</th> <th>最大鉛直速度 (m/s)</th> </tr> </thead> <tbody> <tr> <td>鋼製材</td> <td>4.2×0.3×0.2</td> <td>135</td> <td>57</td> <td>38</td> </tr> </tbody> </table> <p style="text-align: center; margin-top: 10px;">第4-3表 荷重の組合せ</p> <table border="1" style="width: 100%; border-collapse: collapse;"> <thead> <tr> <th>評価施設</th> <th>荷重の組合せ</th> </tr> </thead> <tbody> <tr> <td>ディーゼル発電機室の水密扉</td> <td>W_M</td> </tr> </tbody> </table> </div> <p>4.4 許容限界</p> <p>鋼製構造物に対する既往の評価式による評価における許容限界は、評価対象部位として選定した外殻を構成する扉板の最小部材厚さとする。許容限界を第4-4表に示す。</p> <div data-bbox="73 866 694 1066" style="border: 1px solid black; padding: 5px;"> <p style="text-align: center;">第4-4表 鋼製構造物に対する既往の評価式による評価における許容限界</p> <table border="1" style="width: 100%; border-collapse: collapse;"> <thead> <tr> <th rowspan="2">評価施設</th> <th>許容限界</th> </tr> <tr> <th>部材厚さ(mm)</th> </tr> </thead> <tbody> <tr> <td style="height: 30px;"></td> <td style="background-color: black;"></td> </tr> </tbody> </table> </div> <p>4.5 評価方法</p> <p>評価については、(旧)原子炉安全専門審査会においてタービンミサイル評価の判断基準等を決定することを目的として設置されたタービンミサイル検討会にてまとめられた報告書「タービンミサイル評価について」の中で、鋼板に対する貫通厚さの算出式として使用する旨が記載されている^(注1)以下のBRL式を用いて貫通限界厚さを算出し、許容限界を超えないことを確認する。なお、以下の式は(注1)に記載の式をSI単位系に換算している。</p>	設計飛来物	長さ×幅×奥行き (m)	質量 (kg)	最大水平速度 (m/s)	最大鉛直速度 (m/s)	鋼製材	4.2×0.3×0.2	135	57	38	評価施設	荷重の組合せ	ディーゼル発電機室の水密扉	W _M	評価施設	許容限界	部材厚さ(mm)					
設計飛来物	長さ×幅×奥行き (m)	質量 (kg)	最大水平速度 (m/s)	最大鉛直速度 (m/s)																		
鋼製材	4.2×0.3×0.2	135	57	38																		
評価施設	荷重の組合せ																					
ディーゼル発電機室の水密扉	W _M																					
評価施設	許容限界																					
	部材厚さ(mm)																					

赤字：設備、運用又は体制の相違（設計方針の相違）
 青字：記載箇所又は記載内容の相違（記載方針の相違）
 緑字：記載表現、設備名称の相違（実質的な相違なし）

第6条 外部からの衝撃による損傷の防止（竜巻：別添資料1 添付資料3.11）

大飯発電所3/4号炉	女川原子力発電所2号炉	泊発電所3号炉	相違理由																										
<div data-bbox="80 240 692 344" style="border: 1px solid red; padding: 5px;"> $T^3 = \frac{0.5 \cdot M \cdot V^2}{1.4396 \times 10^9 \cdot K^2 \cdot d^3}$ </div> <p data-bbox="80 376 692 485">（注1）：「タービンミサイルの評価について」の報告書において以下を引用している。ISES7607-3「軽水炉構造機器の衝撃荷重に関する調査 その3 ミサイルの衝突による構造壁の損傷に関する評価式の比較検討」（高温構造安全技術研究組合）</p> <div data-bbox="80 496 692 555" style="border: 1px solid black; padding: 2px;"> <p>枠囲みの範囲は機密に係る事項ですので公開することはできません。</p> </div> <p data-bbox="80 579 692 632">4.6 評価条件 「4.5 評価方法」に用いる評価条件は第4-5表のとおりとする。</p> <div data-bbox="80 667 692 916" style="border: 1px solid red; padding: 5px;"> <p>第4-5表 鋼製構造物に対する既往の評価式による評価に用いる入力値</p> <table border="1" data-bbox="91 699 658 826"> <thead> <tr> <th>記号</th> <th>定義</th> <th>数値</th> <th>単位</th> </tr> </thead> <tbody> <tr> <td>d</td> <td>設計飛来物が衝突する衝突断面の等価直径</td> <td>0.276^{※1}</td> <td>m</td> </tr> <tr> <td>K</td> <td>鋼板の材質に関する係数</td> <td>1^{※1}</td> <td>—</td> </tr> <tr> <td>M</td> <td>設計飛来物の質量</td> <td>135</td> <td>kg</td> </tr> <tr> <td>V</td> <td>設計飛来物の最大水平速度</td> <td>57</td> <td>m/s</td> </tr> </tbody> </table> <p data-bbox="91 831 680 900">※1：「別紙2付録3」に示す電力中央研究所報告「竜巻飛来物を模擬した重錘の鋼板上への自由落下衝突試験による鋼板貫通評価手法の提案」の成果を踏まえたディーゼル発電機室水密扉の貫通評価の考え方に基づき設定</p> </div> <p data-bbox="80 959 692 1038">4.7 評価結果 貫通限界厚さと許容限界との比較を第4-6表に示す。貫通限界厚さが許容限界を超えないことを確認した。</p> <div data-bbox="80 1074 692 1235" style="border: 1px solid red; padding: 5px;"> <p>第4-6表 鋼製構造物に対する既往の評価式による評価に用いる入力値</p> <table border="1" data-bbox="91 1121 680 1203"> <thead> <tr> <th>評価対象</th> <th>評価結果(mm)</th> <th>許容限界(mm)</th> </tr> </thead> <tbody> <tr> <td>ディーゼル発電機室水密扉</td> <td>10.4</td> <td style="border: 2px solid black;"></td> </tr> </tbody> </table> </div>	記号	定義	数値	単位	d	設計飛来物が衝突する衝突断面の等価直径	0.276 ^{※1}	m	K	鋼板の材質に関する係数	1 ^{※1}	—	M	設計飛来物の質量	135	kg	V	設計飛来物の最大水平速度	57	m/s	評価対象	評価結果(mm)	許容限界(mm)	ディーゼル発電機室水密扉	10.4				
記号	定義	数値	単位																										
d	設計飛来物が衝突する衝突断面の等価直径	0.276 ^{※1}	m																										
K	鋼板の材質に関する係数	1 ^{※1}	—																										
M	設計飛来物の質量	135	kg																										
V	設計飛来物の最大水平速度	57	m/s																										
評価対象	評価結果(mm)	許容限界(mm)																											
ディーゼル発電機室水密扉	10.4																												

赤字：設備、運用又は体制の相違（設計方針の相違）
 青字：記載箇所又は記載内容の相違（記載方針の相違）
 緑字：記載表現、設備名称の相違（実質的な相違なし）

第6条 外部からの衝撃による損傷の防止（竜巻：別添資料1 添付資料3.11）

大飯発電所3/4号炉	女川原子力発電所2号炉	泊発電所3号炉	相違理由
<p>5. 3次元FEMモデルを用いた飛来物衝突解析における評価方法 前章までにおいては、鋼製構造物に対する貫通評価式であるBRL式を使用し、評価を実施した。本章以降については、構造解析コードLS-DYNA Version R7.1.2を用いて水密扉及び設計飛来物の3次元FEMモデルを作成し、衝突解析を実施し、BRL式における評価のクロスチェックを実施することとする。3次元FEMモデルを用いた飛来物衝突解析における評価フローを第5-1図に示す。</p> <div style="border: 1px solid black; padding: 5px; margin: 10px 0;"> <p>枠囲みの範囲は機密に係る事項ですので公開することはできません。</p> </div> <div style="border: 1px solid black; padding: 10px; margin: 10px 0;"> <pre> graph TD A[評価対象部位の設定] --> B[密度及び荷重の組合せの設定] B --> C[許容限界の設定] C --> D[解析モデルの設定] D --> E[飛来物衝突解析] E --> F[評価値と許容限界の比較] F --> G[検封終了] </pre> <p>(注) 上記フローのうち、ディーゼル発電機室水密扉への飛来物衝突解析については、解析コード「LS-DYNA(Ver. R7.1.2)」により、水密扉の扉部材を3次元FEMモデルによりモデル化し、評価を実施する。</p> <p>第5-1図 3次元FEMモデルを用いた飛来物衝突解析における評価フロー</p> </div> <p>5.1 評価対象部位 衝突解析における評価対象部位は、設計飛来物の衝突により外殻を構成する扉部材が設計飛来物を貫通させないことを確認するため、「第3-1図 ディーゼル発電機室水密扉の構造概要」を踏まえ、外殻を構成する扉板のうち、安全側に水密扉の裏板のみとし、その他の部材については、考慮しない。</p>			

赤字：設備、運用又は体制の相違（設計方針の相違）
 青字：記載箇所又は記載内容の相違（記載方針の相違）
 緑字：記載表現、設備名称の相違（実質的な相違なし）

第6条 外部からの衝撃による損傷の防止（竜巻：別添資料1 添付資料3.11）

大飯発電所3/4号炉	女川原子力発電所2号炉	泊発電所3号炉	相違理由																						
<p>5.2 荷重及び荷重の組合せ</p> <p>5.2.1 荷重の設定</p> <p>評価に用いる荷重は、以下の荷重を用いる。荷重の算定に用いる竜巻の特性値を第5-1表に示す。なお、気圧差による荷重については、竜巻の風荷重及び飛来物荷重と気圧差荷重の作用方向が異なるため、安全側として考慮しない。</p> <table border="1" data-bbox="80 427 692 603"> <caption>第5-1表 荷重の算定に用いる竜巻の特性値</caption> <thead> <tr> <th>最大風速 V_D (m/s)</th> <th>移動速度 V_T (m/s)</th> <th>最大接線 風速 V_{Rm} (m/s)</th> <th>最大接線 風速半径 R_m (m)</th> <th>最大気圧 低下量 ΔP_{max} (N/m²)</th> <th>最大気圧 低下率 $(dp/dt)_{max}$ (hPa/s)</th> </tr> </thead> <tbody> <tr> <td>100</td> <td>15</td> <td>85</td> <td>30</td> <td>8,900</td> <td>45</td> </tr> </tbody> </table> <p>(1) 風圧力による荷重(W_w)</p> <p>風圧力による荷重 W_w は、下式により算定する。 風力係数 C は、「日本建築学会 建築物荷重指針・同解説」に基づき設定する。 $W_w = q \times G \times C \times A$</p> <p>(2) 設計飛来物による衝撃荷重(W_M)</p> <p>設計飛来物による衝撃荷重 W_M については、第5-2表に示す設計飛来物の衝突に伴う荷重としている。</p> <table border="1" data-bbox="80 954 692 1082"> <caption>第5-2表 設計飛来物の諸元</caption> <thead> <tr> <th>設計 飛来物</th> <th>長さ×幅×奥行き (m)</th> <th>質量 (kg)</th> <th>最大水平速度 (m/s)</th> <th>最大鉛直速度 (m/s)</th> </tr> </thead> <tbody> <tr> <td>鋼製材</td> <td>4.2×0.3×0.2</td> <td>135</td> <td>57</td> <td>38</td> </tr> </tbody> </table> <p>(3) 常時作用する荷重(F_d)</p> <p>常時作用する荷重 F_d として、自重を考慮する。</p> <p>5.2.2 荷重の組合せ</p> <p>「5.2.1 荷重の設定」を踏まえ、荷重の組合せを第5-3表に示す。</p>	最大風速 V_D (m/s)	移動速度 V_T (m/s)	最大接線 風速 V_{Rm} (m/s)	最大接線 風速半径 R_m (m)	最大気圧 低下量 ΔP_{max} (N/m ²)	最大気圧 低下率 $(dp/dt)_{max}$ (hPa/s)	100	15	85	30	8,900	45	設計 飛来物	長さ×幅×奥行き (m)	質量 (kg)	最大水平速度 (m/s)	最大鉛直速度 (m/s)	鋼製材	4.2×0.3×0.2	135	57	38			
最大風速 V_D (m/s)	移動速度 V_T (m/s)	最大接線 風速 V_{Rm} (m/s)	最大接線 風速半径 R_m (m)	最大気圧 低下量 ΔP_{max} (N/m ²)	最大気圧 低下率 $(dp/dt)_{max}$ (hPa/s)																				
100	15	85	30	8,900	45																				
設計 飛来物	長さ×幅×奥行き (m)	質量 (kg)	最大水平速度 (m/s)	最大鉛直速度 (m/s)																					
鋼製材	4.2×0.3×0.2	135	57	38																					

赤字：設備、運用又は体制の相違（設計方針の相違）
 青字：記載箇所又は記載内容の相違（記載方針の相違）
 緑字：記載表現、設備名称の相違（実質的な相違なし）

第6条 外部からの衝撃による損傷の防止（竜巻：別添資料1 添付資料3.11）

大飯発電所3/4号炉	女川原子力発電所2号炉	泊発電所3号炉	相違理由								
<p style="text-align: center;">第5-3表 荷重の組合せ</p> <table border="1" style="margin-left: auto; margin-right: auto;"> <thead> <tr> <th>評価対象</th> <th>荷重の組合せ</th> </tr> </thead> <tbody> <tr> <td>ディーゼル発電機室の水密扉</td> <td>$W_w+W_M+F_d$</td> </tr> </tbody> </table> <p>5.3 許容限界 飛来物衝突解析における許容限界については、水密扉裏板のJIS値から算出した破断ひずみとする。破断ひずみの設定方法は「5.4 評価方法」に示す。許容限界を第5-4表に示す。</p> <p style="text-align: center;">第5-4表 飛来物衝突解析における許容限界</p> <table border="1" style="margin-left: auto; margin-right: auto;"> <thead> <tr> <th>評価対象</th> <th>許容限界</th> </tr> </thead> <tbody> <tr> <td>ディーゼル発電機室の水密扉の裏板</td> <td></td> </tr> </tbody> </table> <p style="text-align: center;">枠囲みの範囲は機密に係る事項ですので公開することはできません。</p> <p>5.4 評価方法 ディーゼル発電機室水密扉の飛来物衝突解析は「5.2.2 荷重の組合せ」にて設定した荷重に対し、3次元FEMモデルによる飛来物衝突解析を実施することにより、ディーゼル発電機室水密扉に発生する破断ひずみが許容限界を超えないことを確認する。</p> <p>(1) 解析モデル モデル化範囲は安全側にディーゼル発電機室水密扉の裏板のみとし、表板貫通による衝突エネルギーの損失は考慮しない。設計飛来物である鋼製材は厚さ4.25mmの角型鋼管としてモデル化する。 設計飛来物はシェル要素、ディーゼル発電機室水密扉については、ソリッド要素でモデル化する。 解析モデルの境界条件は、安全側に水密扉の周囲四辺を完全固定とする。設計飛来物及びディーゼル発電機室水密扉の解析事象の概略図を第5-1図、解析モデルを第5-2図に示す。解析コード「LS-DYNA Version R7.1.2」を用いる。</p>	評価対象	荷重の組合せ	ディーゼル発電機室の水密扉	$W_w+W_M+F_d$	評価対象	許容限界	ディーゼル発電機室の水密扉の裏板				
評価対象	荷重の組合せ										
ディーゼル発電機室の水密扉	$W_w+W_M+F_d$										
評価対象	許容限界										
ディーゼル発電機室の水密扉の裏板											

赤字：設備，運用又は体制の相違（設計方針の相違）
 青字：記載箇所又は記載内容の相違（記載方針の相違）
 緑字：記載表現，設備名称の相違（実質的な相違なし）

第6条 外部からの衝撃による損傷の防止（竜巻：別添資料1 添付資料3.11）

大飯発電所3/4号炉	女川原子力発電所2号炉	泊発電所3号炉	相違理由
<div data-bbox="85 231 568 619" style="border: 2px solid black; width: 100%; height: 100%;"></div> <p data-bbox="71 624 582 646">第5-1図 設計飛来物及びディーゼル発電機室水密扉の解析事象の概略図</p> <div data-bbox="197 810 689 837" style="border: 1px solid black; padding: 2px; margin-top: 20px;"> <p data-bbox="241 815 645 833">検閲みの範囲は機密に係る事項ですので公開することはできません。</p> </div>			

赤字：設備、運用又は体制の相違（設計方針の相違）
 青字：記載箇所又は記載内容の相違（記載方針の相違）
 緑字：記載表現、設備名称の相違（実質的な相違なし）

第6条 外部からの衝撃による損傷の防止（竜巻：別添資料1 添付資料3.11）

大飯発電所3/4号炉	女川原子力発電所2号炉	泊発電所3号炉	相違理由												
<div data-bbox="85 229 692 687" data-label="Image"> </div> <p data-bbox="129 703 685 730">第5-2図 設計飛来物及びディーゼル発電機室水密扉の解析モデル</p> <p data-bbox="73 780 320 805">(2) 使用材料及び材料定数</p> <p data-bbox="73 809 696 865">設計飛来物及びディーゼル発電機室水密扉の材料定数をそれぞれ第5-5表及び第5-6表に示す。</p> <p data-bbox="230 906 515 932">第5-5表 設計飛来物の材料定数</p> <table border="1" data-bbox="141 933 620 1048"> <thead> <tr> <th>材料種類</th> <th>ヤング係数 (N/mm²)</th> <th>単位体積重量 (kN/m³)</th> </tr> </thead> <tbody> <tr> <td>SN490B</td> <td></td> <td></td> </tr> </tbody> </table> <p data-bbox="172 1112 584 1139">第5-6表 ディーゼル発電機室水密扉の材料定数</p> <table border="1" data-bbox="141 1141 620 1256"> <thead> <tr> <th>材料種類</th> <th>ヤング係数 (N/mm²)</th> <th>単位体積重量 (kN/m³)</th> </tr> </thead> <tbody> <tr> <td></td> <td></td> <td></td> </tr> </tbody> </table> <p data-bbox="73 1303 282 1331">(3) 材料の非線形特性</p> <p data-bbox="73 1332 692 1417">材料の非線形特性については、ひずみ速度依存性を考慮するため、各材料に対して、以下の式で示される Cowper-Symonds モデル^(注2)を使用した。</p>	材料種類	ヤング係数 (N/mm ²)	単位体積重量 (kN/m ³)	SN490B			材料種類	ヤング係数 (N/mm ²)	単位体積重量 (kN/m ³)						
材料種類	ヤング係数 (N/mm ²)	単位体積重量 (kN/m ³)													
SN490B															
材料種類	ヤング係数 (N/mm ²)	単位体積重量 (kN/m ³)													

赤字：設備、運用又は体制の相違（設計方針の相違）
 青字：記載箇所又は記載内容の相違（記載方針の相違）
 緑字：記載表現、設備名称の相違（実質的な相違なし）

第6条 外部からの衝撃による損傷の防止（竜巻：別添資料1 添付資料3.11）

大飯発電所3/4号炉	女川原子力発電所2号炉	泊発電所3号炉	相違理由
<div data-bbox="85 236 293 320" data-label="Equation-Block"> $\sigma_{eq} = \left[A + B \varepsilon_{pl} \left(1 + \left(\frac{\varepsilon_{pl}^*}{D} \right)^{1/q} \right) \right]$ </div> <div data-bbox="219 347 683 375" data-label="Text"> <p>枠囲みの範囲は機密に係る事項ですので公開することはできません。</p> </div> <div data-bbox="91 443 622 470" data-label="Text"> <p>σ_{eq}：相当応力(N/mm²)、A：降伏応力(N/mm²)、B：硬化係数(N/mm²)、</p> </div> <div data-bbox="91 497 678 526" data-label="Text"> <p>D,q：ひずみ速度係数、ε_{pl}：相当塑性ひずみ、ε_{pl}^*：無次元相当塑性ひずみ速度</p> </div> <div data-bbox="73 576 696 777" data-label="Text"> <p>また、第5-7表に解析で使用した材料物性値、第5-3図に応力-ひずみ関係を示す。真応力-真ひずみ関係は、パイリニア型とし、第一折れ点は「降伏応力-降伏ひずみ」、終局点は「破断応力-破断ひずみ」とする。また、ディーゼル発電機室の水密扉については、破断ひずみを超えた要素を削除することにより、部材の破壊を表現する。飛来物については、安全側に破断ひずみを超えた要素についても削除せず荷重を負担するものとする。</p> </div> <div data-bbox="73 778 685 865" data-label="Text"> <p>ひずみ速度係数D、qは、ひずみ速度依存性を考慮する際に使用するパラメータである。解析で使用する各部材の動的物性値については、日本溶接協会の推定式(WES式)^(注3)を準用した。</p> </div> <div data-bbox="85 898 678 1000" data-label="Text"> <p>破断ひずみは「NEI 07-13」^(注4)においてTF（多軸性係数）を考慮することが推奨されていることから、とし、ディーゼル発電機室水密扉はとする。TFは安全側にディーゼル発電機室水密扉はとする。</p> </div> <div data-bbox="73 1042 696 1125" data-label="Text"> <p>Cowper-Symondsモデル及び日本溶接協会の推定式(WES式)の使用については、「参考資料1付録1」に記載の電中研報告書において重錘落下試験と解析結果がよく整合することを確認している。</p> </div> <div data-bbox="73 1157 696 1240" data-label="Text"> <p>(注2)「(独)原子力安全基盤機構：原子力発電施設等に係る構造物の爆発衝撃荷重挙動解析(JNES/SSD08-014)、平成20年11月」にて使用しているモデルである。</p> </div> <div data-bbox="73 1241 696 1327" data-label="Text"> <p>(注3)「(一社)日本原子力技術協会：BWR配管における混合ガス(水素・酸素)の燃焼による配管損傷防止に関するガイドライン(第3版)平成22年3月」</p> </div> <div data-bbox="73 1331 665 1415" data-label="Text"> <p>(注4)「Methodology for Performing Aircraft Impact Assessments for New Plant Designs (Nuclear Energy Institute 2011 Rev8(NEI 07-13))」</p> </div>			

赤字：設備、運用又は体制の相違（設計方針の相違）
 青字：記載箇所又は記載内容の相違（記載方針の相違）
 緑字：記載表現、設備名称の相違（実質的な相違なし）

第6条 外部からの衝撃による損傷の防止（竜巻：別添資料1 添付資料3.11）

大飯発電所3/4号炉	女川原子力発電所2号炉	泊発電所3号炉	相違理由																																		
<div data-bbox="80 228 689 790" style="border: 1px solid red; padding: 5px;"> <p style="text-align: center;">第5-7表 解析で使用した材料物性値</p> <table border="1" style="width: 100%; border-collapse: collapse;"> <thead> <tr> <th rowspan="2">種別</th> <th rowspan="2">材質</th> <th>降伏応力</th> <th>硬化係数</th> <th colspan="2">ひずみ速度係数</th> <th>破断</th> </tr> <tr> <th>A(N/mm²)</th> <th>B(N/mm²)</th> <th>D</th> <th>q</th> <th>ひずみ</th> </tr> </thead> <tbody> <tr> <td>ディーゼル発電機室の水密扉</td> <td></td> <td></td> <td></td> <td></td> <td></td> <td></td> </tr> <tr> <td>設計飛来物</td> <td>SN490B</td> <td></td> <td></td> <td></td> <td></td> <td>0.05</td> </tr> </tbody> </table> <p>(注)安全側に飛来物の破断は考慮しない。</p> <div style="border: 1px solid black; padding: 2px; margin: 5px 0;"> 伸びみの範囲は機密に係る事項ですので公開することはできません。 </div> <div style="border: 2px solid black; height: 100px; margin: 10px 0;"></div> <p style="text-align: center;">(ディーゼル発電機室の水密扉) (設計飛来物) 第5-3図 解析に使用した応力-ひずみ関係</p> </div> <p>5.5 評価条件 3次元FEMモデルを用いた飛来物衝突解析における評価は扉部材の最大変形が生じると想定される鋼板中央部に衝突するケースを設定する。 解析ケースを第5-8表及び第5-4図に示す。</p> <div data-bbox="80 986 689 1157" style="border: 1px solid red; padding: 5px; margin-top: 10px;"> <p style="text-align: center;">第5-8表 解析ケース</p> <table border="1" style="width: 100%; border-collapse: collapse;"> <thead> <tr> <th>評価箇所</th> <th>衝突箇所</th> <th>飛来物の衝突方向</th> <th>対象部材</th> </tr> </thead> <tbody> <tr> <td>ディーゼル発電機室水密扉</td> <td>裏板</td> <td>水平</td> <td></td> </tr> </tbody> </table> </div>	種別	材質	降伏応力	硬化係数	ひずみ速度係数		破断	A(N/mm ²)	B(N/mm ²)	D	q	ひずみ	ディーゼル発電機室の水密扉							設計飛来物	SN490B					0.05	評価箇所	衝突箇所	飛来物の衝突方向	対象部材	ディーゼル発電機室水密扉	裏板	水平				
種別			材質	降伏応力	硬化係数	ひずみ速度係数		破断																													
	A(N/mm ²)	B(N/mm ²)		D	q	ひずみ																															
ディーゼル発電機室の水密扉																																					
設計飛来物	SN490B					0.05																															
評価箇所	衝突箇所	飛来物の衝突方向	対象部材																																		
ディーゼル発電機室水密扉	裏板	水平																																			

赤字：設備、運用又は体制の相違（設計方針の相違）
 青字：記載箇所又は記載内容の相違（記載方針の相違）
 緑字：記載表現、設備名称の相違（実質的な相違なし）

第6条 外部からの衝撃による損傷の防止（竜巻：別添資料1 添付資料3.11）

大飯発電所3/4号炉	女川原子力発電所2号炉	泊発電所3号炉	相違理由						
<div data-bbox="85 167 560 534" style="border: 2px solid black; height: 230px; width: 212px; margin-bottom: 10px;"></div> <p data-bbox="224 539 403 561">第5-4図 解析ケース図</p> <div data-bbox="183 593 683 625" style="border: 1px solid black; padding: 2px; margin-bottom: 10px;"> 枠囲みの範囲は機密に係る事項ですので公開することはできません。 </div> <p data-bbox="73 667 201 689">5.6 評価結果</p> <p data-bbox="73 695 694 775">設計飛来物の衝突により水密扉に発生するひずみと許容限界の比較を第5-9表に示す。発生ひずみが許容限界を超えないことを確認した。</p> <p data-bbox="73 782 694 951">参考として、第5-5図に設計飛来物の速度の時刻歴、第5-6図にディーゼル発電機室水密扉のミーゼス応力の最大値の時刻歴、第5-7図にディーゼル発電機室水密扉の相当塑性ひずみの最大値の時刻歴及び第5-8図に解析終了時のディーゼル発電機室水密扉のミーゼス応力分布図（全体図）、第5-9図に鋼板のエネルギー内訳の時刻歴推移、第5-10図に飛来物のエネルギー内訳の時刻歴推移を示す。</p> <div data-bbox="73 973 694 1165" style="border: 1px solid black; padding: 5px; margin-bottom: 10px;"> <p data-bbox="224 997 560 1019">第5-9表 飛来物衝突解析による評価結果</p> <table border="1" data-bbox="145 1024 631 1141"> <thead> <tr> <th data-bbox="145 1024 353 1082">評価項目</th> <th data-bbox="353 1024 488 1082">評価結果</th> <th data-bbox="488 1024 631 1082">許容限界</th> </tr> </thead> <tbody> <tr> <td data-bbox="145 1082 353 1141">ディーゼル発電機室水密扉のひずみ</td> <td data-bbox="353 1082 488 1141" style="border: 2px solid black;"></td> <td data-bbox="488 1082 631 1141"></td> </tr> </tbody> </table> </div> <p data-bbox="73 1189 168 1211">6. まとめ</p> <p data-bbox="73 1217 694 1358">ディーゼル発電機室水密扉への設計飛来物の衝突による貫通有無に対して、「鋼製構造物に対する既往の貫通評価式(BRL式)における貫通評価」及び「構造解析コードLS-DYNAVersion R7.1.2を用いた飛来物衝突評価」により評価を実施した結果、いずれの評価においても貫通しないことが確認できた。</p> <p data-bbox="73 1364 694 1415">以上より、ディーゼル発電機室水密扉は設計飛来物の衝突により貫通しないといえる。</p> <div data-bbox="85 1428 683 1460" style="border: 1px solid black; padding: 2px;"> 枠囲みの範囲は機密に係る事項ですので公開することはできません。 </div>	評価項目	評価結果	許容限界	ディーゼル発電機室水密扉のひずみ					
評価項目	評価結果	許容限界							
ディーゼル発電機室水密扉のひずみ									

赤字：設備、運用又は体制の相違（設計方針の相違）
 青字：記載箇所又は記載内容の相違（記載方針の相違）
 緑字：記載表現、設備名称の相違（実質的な相違なし）

第6条 外部からの衝撃による損傷の防止（竜巻：別添資料1 添付資料3.11）

大飯発電所3/4号炉	女川原子力発電所2号炉	泊発電所3号炉	相違理由
<div data-bbox="85 225 685 644" style="border: 2px solid black; height: 263px; width: 268px; margin-bottom: 20px;"></div> <div data-bbox="262 654 555 681" data-label="Caption"> <p>第5-5図 設計飛来物の速度の時刻歴</p> </div> <div data-bbox="85 730 616 1088" style="border: 2px solid black; height: 224px; width: 237px; margin-bottom: 20px;"></div> <div data-bbox="123 1098 622 1125" data-label="Caption"> <p>第5-6図 ディーゼル発電機室水密扉のミーゼス応力の最大値の時刻歴</p> </div> <div data-bbox="192 1342 685 1374" style="border: 1px solid black; padding: 2px; margin-top: 20px;"> <p>枠囲みの範囲は機密に係る事項ですので公開することはできません。</p> </div>			

赤字：設備、運用又は体制の相違（設計方針の相違）
 青字：記載箇所又は記載内容の相違（記載方針の相違）
 緑字：記載表現、設備名称の相違（実質的な相違なし）

第6条 外部からの衝撃による損傷の防止（竜巻：別添資料1 添付資料3.11）

大飯発電所3/4号炉	女川原子力発電所2号炉	泊発電所3号炉	相違理由
<div data-bbox="91 240 680 655" style="border: 2px solid black; height: 260px; margin-bottom: 10px;"></div> <div data-bbox="91 659 680 683"> <p>第5-7図 ディーゼル発電機室水密扉の相当塑性ひずみの最大値の時刻歴</p> </div> <div data-bbox="91 740 656 1251" style="border: 2px solid black; height: 320px; margin-bottom: 10px;"></div> <div data-bbox="91 1254 656 1278"> <p>第5-8図 解析終了時のディーゼル発電機室水密扉のミーゼス応力分布図（全体図）</p> </div> <div data-bbox="219 1310 680 1342" style="border: 1px solid black; padding: 2px; margin-top: 10px;"> <p>作図みの範囲は機密に係る事項ですので公開することはできません。</p> </div>			

赤字：設備、運用又は体制の相違（設計方針の相違）
 青字：記載箇所又は記載内容の相違（記載方針の相違）
 緑字：記載表現、設備名称の相違（実質的な相違なし）

第6条 外部からの衝撃による損傷の防止（竜巻：別添資料1 添付資料3.11）

大飯発電所3/4号炉	女川原子力発電所2号炉	泊発電所3号炉	相違理由
<div data-bbox="85 236 689 657" style="border: 2px solid black; height: 264px; width: 270px; margin-bottom: 10px;"></div> <div data-bbox="230 659 562 683" style="font-size: small;">第5-9図 鋼板のエネルギー内訳の時刻歴推移</div> <div data-bbox="85 730 645 1091" style="border: 2px solid black; height: 226px; width: 250px; margin-bottom: 10px;"></div> <div data-bbox="208 1093 535 1118" style="font-size: small;">第5-10図 飛来物のエネルギー内訳の時刻歴推移</div> <div data-bbox="230 1289 689 1313" style="border: 1px solid black; font-size: x-small; padding: 2px;">枠囲みの範囲は機密に係る事項ですので公開することはできません。</div>			

赤字：設備、運用又は体制の相違（設計方針の相違）
 青字：記載箇所又は記載内容の相違（記載方針の相違）
 緑字：記載表現、設備名称の相違（実質的な相違なし）

第6条 外部からの衝撃による損傷の防止（竜巻：別添資料1 添付資料3.11）

大飯発電所3/4号炉	女川原子力発電所2号炉	泊発電所3号炉	相違理由
<p style="text-align: center;">別紙2 付録1</p> <p>電力中央研究所報告「竜巻飛来物を模擬した重錘の鋼板上への自由落下衝突試験による鋼板貫通評価手法の提案」の概要（平成27年10月8日発刊から抜粋し、編集）</p> <p>1. 試験の目的</p> <p>鋼板の貫通限界厚さに関する既往の評価式として、BRL式が知られており、以下の式で表される。</p> <div style="border: 1px solid black; padding: 5px; margin: 10px 0;"> $T^{\frac{3}{2}} = \frac{0.5 \cdot M \cdot V^2}{1.4396 \times 10^9 \cdot K^2 \cdot d^{\frac{3}{2}}}$ <p>ここで、</p> <ul style="list-style-type: none"> T：貫通限界厚さ(m) M：設計飛来物の質量(kg) V：設計飛来物の速度(m/s) d：設計飛来物が衝突する衝突断面の等価直径(m) K：鋼板の材質に関する係数(=1) </div> <p>BRL式については、根拠データが明示されていない。従って、角型パイプ形状の鋼製材を対象として、BRL式への入力値である飛来物直径に換算する場合、第1-1図に示す三種類の換算方法が考えられる。</p> <ol style="list-style-type: none"> ①衝突部の接触面積と等価な面積を持つ円の直径と仮定 ②衝突部の投影面積と等価な面積を持つ円の直径と仮定 ③衝突部の周長と等価な周長を持つ円の直径と仮定 <p>BRL式では、飛来物直径が小さくなるほど貫通限界厚さが大きく算定されるため、最も保守的な換算方法は①であるが、②や③の換算方法に比べて非常に大きな値となり、実務設計に及ぼす影響が極めて大きくなることから適切な安全裕度を有する使用方法の知見を得ておく必要がある。</p> <p>また、BRL式中では、鋼板の等級に関わる係数Kが用いられているが、鋼種に応じた数値の記載もない。このため、例えば炭素鋼やステンレス鋼が材料の持つ延性等に関係なく同一の評価値を与えることになる。実際の衝突試験結果とBRL式による評価結果を比較することで適切な等価直径の設定方法と延性材料の使用による貫通限界厚さの低減効果についても明確にしておく必要があり、本評価式の適切な適用性等を明らかにすること等が本試験の目的である。</p>			

赤字：設備、運用又は体制の相違（設計方針の相違）
 青字：記載箇所又は記載内容の相違（記載方針の相違）
 緑字：記載表現、設備名称の相違（実質的な相違なし）

第6条 外部からの衝撃による損傷の防止（竜巻：別添資料1 添付資料3.11）

大飯発電所3/4号炉	女川原子力発電所2号炉	泊発電所3号炉	相違理由
<div data-bbox="73 231 692 683" data-label="Diagram"> <p>第1-1図 飛来物直径の換算方法</p> </div> <div data-bbox="73 722 692 893" data-label="Text"> <p>2. 試験の概要 設計飛来物である鋼製材の先端形状を模擬した重錘を用いた自由落下衝突試験の試験概要を第2-1図に示す。試験では、型網で組み上げた支持架台と試験体押さえ枠の間に試験体を二辺支持固定し、移動式クレーンで脱着装置を介して吊り上げた重錘を自由落下させて試験体を衝突させた。</p> </div> <div data-bbox="73 917 692 1455" data-label="Diagram"> <p>第2-1図 試験装置の概要</p> </div>			

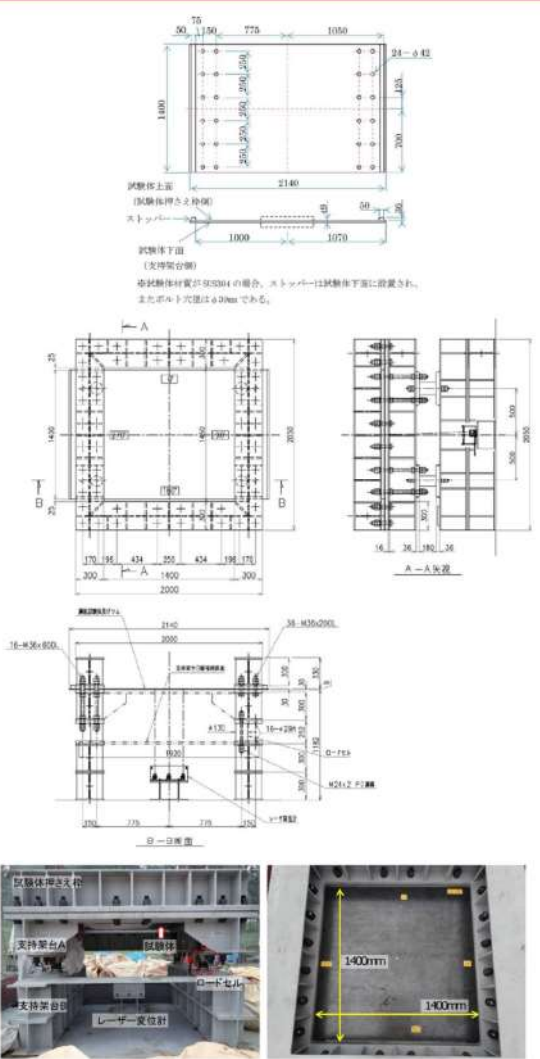

赤字：設備、運用又は体制の相違（設計方針の相違）
 青字：記載箇所又は記載内容の相違（記載方針の相違）
 緑字：記載表現、設備名称の相違（実質的な相違なし）

第6条 外部からの衝撃による損傷の防止（竜巻：別添資料1 添付資料3.11）

大飯発電所3/4号炉	女川原子力発電所2号炉	泊発電所3号炉	相違理由
<p>3. 鋼板の試験体</p> <p>第3-1図に試験体、支持架台および試験体押さえ枠の組立図および概観を示す。試験体はSS400及びSUS304の2種類の鋼板であり、試験体の被衝突面として有効な寸法は長さ1400mm×幅1400mmあり、試験体の厚さは9mmである。</p>  <p>第3-1図 試験体、支持架台および試験体押さえ枠の組立図および概観</p>			

赤字：設備、運用又は体制の相違（設計方針の相違）
 青字：記載箇所又は記載内容の相違（記載方針の相違）
 緑字：記載表現、設備名称の相違（実質的な相違なし）

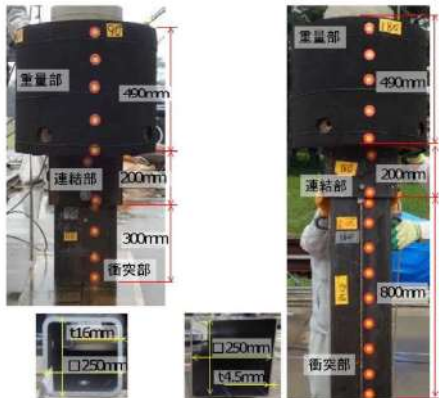
第6条 外部からの衝撃による損傷の防止（竜巻：別添資料1 添付資料3.11）

大飯発電所3/4号炉	女川原子力発電所2号炉	泊発電所3号炉	相違理由																				
<p>4. 設計飛来物を模擬した重錘の形状</p> <p>設計飛来物である鋼製材と同一の寸法とした場合、クレーンの吊り上げ高さの制約から設計飛来物の水平方向速度に相当する運動エネルギーを模擬することができないことから、試験においては、鋼製材の先端形状を模擬した付加質量付き重錘を用いて鋼製材の衝突に係る運動エネルギーを模擬できるようにしている。</p> <p>第4-1表に試験に用いた重錘の寸法、重量、第4-1図に重錘の概観を示す。</p> <div data-bbox="78 399 689 1212" style="border: 1px solid red; padding: 5px;"> <p style="text-align: center;">第4-1表 設計飛来物である鋼製材及び試験に用いた重錘の形状</p> <table border="1" style="width: 100%; border-collapse: collapse;"> <thead> <tr> <th>飛来物</th> <th>断面形状(mm)</th> <th>衝突部長さ(mm)</th> <th>重量(kg)</th> <th>定義</th> </tr> </thead> <tbody> <tr> <td>設計飛来物（鋼製材）</td> <td>200×300×t4.2</td> <td>4200</td> <td>135</td> <td>—</td> </tr> <tr> <td>剛パイプ重錘</td> <td>250×250×t16</td> <td>500</td> <td>1114.3</td> <td>衝撃圧潰変形が生じないと想定される十分な厚みを持たせた角型パイプ</td> </tr> <tr> <td>柔パイプ重錘</td> <td>250×250×t4.5</td> <td>1000</td> <td>1092.3</td> <td>ガイドの鋼製材を模擬した角型パイプ</td> </tr> </tbody> </table> <p style="font-size: small;">※1：補足説明資料8「設計飛来物の設定について」における剛飛来物、柔飛来物とは定義が異なる。</p> <div style="display: flex; justify-content: space-around; align-items: center;"> <div style="text-align: center;">  <p>(剛パイプ重錘)</p> </div> <div style="text-align: center;">  <p>(柔パイプ重錘)</p> </div> </div> <p style="text-align: center;">第4-1図 重錘の概観</p> </div>	飛来物	断面形状(mm)	衝突部長さ(mm)	重量(kg)	定義	設計飛来物（鋼製材）	200×300×t4.2	4200	135	—	剛パイプ重錘	250×250×t16	500	1114.3	衝撃圧潰変形が生じないと想定される十分な厚みを持たせた角型パイプ	柔パイプ重錘	250×250×t4.5	1000	1092.3	ガイドの鋼製材を模擬した角型パイプ			
飛来物	断面形状(mm)	衝突部長さ(mm)	重量(kg)	定義																			
設計飛来物（鋼製材）	200×300×t4.2	4200	135	—																			
剛パイプ重錘	250×250×t16	500	1114.3	衝撃圧潰変形が生じないと想定される十分な厚みを持たせた角型パイプ																			
柔パイプ重錘	250×250×t4.5	1000	1092.3	ガイドの鋼製材を模擬した角型パイプ																			
<p>5. 試験条件</p> <p>第5-1表に自由落下衝突試験条件の一覧を示す。試験SS-1～SS-4は、剛パイプ重錘を対象とし落下高さをパラメータとした解析ケース（被衝突体の材質はSS400）である。試験SS-5は、柔パイプ重錘による被衝突体の損傷軽減度合いを確認する。また、試験SUS-1では、延性に富む材料（SUS304）による貫通限界厚さの低減効果を確認する。</p>																							

赤字：設備、運用又は体制の相違（設計方針の相違）
 青字：記載箇所又は記載内容の相違（記載方針の相違）
 緑字：記載表現、設備名称の相違（実質的な相違なし）

第6条 外部からの衝撃による損傷の防止（竜巻：別添資料1 添付資料3.11）

大飯発電所3/4号炉	女川原子力発電所2号炉	泊発電所3号炉	相違理由																																																																																																									
<p style="text-align: center;">第5-1表 落下衝突試験条件一覧</p> <table border="1" data-bbox="85 225 687 486"> <thead> <tr> <th>試験ケース</th> <th colspan="2">試験目的</th> <th>重錘</th> <th>鋼板試験体</th> <th>落下高さ</th> <th>衝突エネルギー</th> </tr> </thead> <tbody> <tr> <td>SS-1</td> <td rowspan="4">SS400 剛</td> <td>BRL 六ノ投影面積</td> <td rowspan="4">剛</td> <td rowspan="4">SS400</td> <td>17.0m</td> <td>186kJ</td> </tr> <tr> <td>SS-2</td> <td>板の貫通</td> <td>ひずみの工学的下限値近傍^{※1}</td> <td>12.5m</td> <td>137kJ</td> </tr> <tr> <td>SS-3</td> <td>限界の値</td> <td>鉛直方向衝突速度 38m/s 相当</td> <td>9.5m</td> <td>104kJ</td> </tr> <tr> <td>SS-4</td> <td>脆</td> <td>ひずみの工学的下限値近傍^{※1}</td> <td>11.0m^{※2}</td> <td>120kJ</td> </tr> <tr> <td>SS-5</td> <td colspan="2">飛来物による貫通限界厚さの 低減効果の確認</td> <td>柔</td> <td>SS400</td> <td>17.0m</td> <td>182kJ</td> </tr> <tr> <td>SUS-1</td> <td colspan="2">SUS304における貫通限界厚さの 低減効果の確認</td> <td>剛</td> <td>SUS304</td> <td>17.0m</td> <td>186kJ</td> </tr> </tbody> </table> <p>※1：飛来物衝突の解析コード AUTODYN における事前解析において、材料試験における引張ひずみ相当(14.9%)が発生する試験ケース ※2：SS-2 と SS-3 の中間高さ</p> <p>6. 試験結果</p> <p>第6-1表及び第6-1図に試験結果一覧及び試験後の試験体の破壊状況を示す。</p> <p>剛パイプ重錘を用いた試験（試験 SS-1～SS-4）では、試験 SS-1 及び SS-2 で貫通が生じたが、試験 SS-3 と試験 SS-4 では貫通は発生していない。これより、1400mm×1400mm×厚さ 9mm の SS400 鋼板の貫通限界となる衝突エネルギーは 137kJ（試験 SS-2）と 120kJ（試験 SS-4）の間となり、設計飛来物である鋼製材の鉛直方向速度 38m/s 相当の衝突エネルギー104kJ に対して貫通防止可能であると共に、貫通はひずみの工学的下限値近傍(14.9%)で発生することも示唆される。一方、柔パイプ重錘を用いた試験（試験 SS-5）では、第6-2図に示すように、衝突部の衝撃圧潰変形（変形量：300mm）により衝突エネルギーの一部が吸収されるため、鋼板試験体の貫通は発生していない。</p> <p>また、延性に富む SUS304 鋼板に重錘を衝突させた試験（試験 SUS-1）では貫通は発生しておらず、SUS304 は SS400 より延性が大きいために局所的なひずみの限界値が高く、設計飛来物である鋼製材に対する耐貫通性に優れた材料であることが示された。</p> <p style="text-align: center;">第6-1表 試験結果一覧</p> <table border="1" data-bbox="85 1161 687 1417"> <thead> <tr> <th rowspan="2">試験ケース</th> <th colspan="4">SS400・剛</th> <th>SS400・柔</th> <th>SUS304・剛</th> </tr> <tr> <th>SS-1</th> <th>SS-2</th> <th>SS-3</th> <th>SS-4</th> <th>SS-5</th> <th>SUS-1</th> </tr> </thead> <tbody> <tr> <td>貫通</td> <td>有</td> <td>有</td> <td>無</td> <td>無</td> <td>無</td> <td>無</td> </tr> <tr> <td>衝突エネルギー(kJ)</td> <td>186</td> <td>137</td> <td>104</td> <td>120</td> <td>182</td> <td>186</td> </tr> <tr> <td>衝突速度(m/s)</td> <td>18.3</td> <td>15.7</td> <td>13.7</td> <td>14.7</td> <td>18.3</td> <td>18.3</td> </tr> <tr> <td>最大荷重(kN)</td> <td>2714</td> <td>2268</td> <td>2011</td> <td>2027</td> <td>2392</td> <td>2454</td> </tr> <tr> <td>最大力積(kN・s)</td> <td>13.6</td> <td>14.8</td> <td>22.5</td> <td>21.6</td> <td>21.7</td> <td>30.0</td> </tr> <tr> <td>最大変位(mm)^{※1}</td> <td>163</td> <td>161</td> <td>168</td> <td>172</td> <td>145</td> <td>201</td> </tr> <tr> <td>現象時間(sec)^{※2}</td> <td>0.0156</td> <td>0.0196</td> <td>0.0252</td> <td>0.0251</td> <td>0.0652</td> <td>0.0233</td> </tr> </tbody> </table> <p>※1：試験体の鉛直方向の変形量 ※2：重錘が試験体に衝突してからロードセル発着が0となるまでの時間</p>	試験ケース	試験目的		重錘	鋼板試験体	落下高さ	衝突エネルギー	SS-1	SS400 剛	BRL 六ノ投影面積	剛	SS400	17.0m	186kJ	SS-2	板の貫通	ひずみの工学的下限値近傍 ^{※1}	12.5m	137kJ	SS-3	限界の値	鉛直方向衝突速度 38m/s 相当	9.5m	104kJ	SS-4	脆	ひずみの工学的下限値近傍 ^{※1}	11.0m ^{※2}	120kJ	SS-5	飛来物による貫通限界厚さの 低減効果の確認		柔	SS400	17.0m	182kJ	SUS-1	SUS304における貫通限界厚さの 低減効果の確認		剛	SUS304	17.0m	186kJ	試験ケース	SS400・剛				SS400・柔	SUS304・剛	SS-1	SS-2	SS-3	SS-4	SS-5	SUS-1	貫通	有	有	無	無	無	無	衝突エネルギー(kJ)	186	137	104	120	182	186	衝突速度(m/s)	18.3	15.7	13.7	14.7	18.3	18.3	最大荷重(kN)	2714	2268	2011	2027	2392	2454	最大力積(kN・s)	13.6	14.8	22.5	21.6	21.7	30.0	最大変位(mm) ^{※1}	163	161	168	172	145	201	現象時間(sec) ^{※2}	0.0156	0.0196	0.0252	0.0251	0.0652	0.0233			
試験ケース	試験目的		重錘	鋼板試験体	落下高さ	衝突エネルギー																																																																																																						
SS-1	SS400 剛	BRL 六ノ投影面積	剛	SS400	17.0m	186kJ																																																																																																						
SS-2		板の貫通			ひずみの工学的下限値近傍 ^{※1}	12.5m	137kJ																																																																																																					
SS-3		限界の値			鉛直方向衝突速度 38m/s 相当	9.5m	104kJ																																																																																																					
SS-4		脆			ひずみの工学的下限値近傍 ^{※1}	11.0m ^{※2}	120kJ																																																																																																					
SS-5	飛来物による貫通限界厚さの 低減効果の確認		柔	SS400	17.0m	182kJ																																																																																																						
SUS-1	SUS304における貫通限界厚さの 低減効果の確認		剛	SUS304	17.0m	186kJ																																																																																																						
試験ケース	SS400・剛				SS400・柔	SUS304・剛																																																																																																						
	SS-1	SS-2	SS-3	SS-4	SS-5	SUS-1																																																																																																						
貫通	有	有	無	無	無	無																																																																																																						
衝突エネルギー(kJ)	186	137	104	120	182	186																																																																																																						
衝突速度(m/s)	18.3	15.7	13.7	14.7	18.3	18.3																																																																																																						
最大荷重(kN)	2714	2268	2011	2027	2392	2454																																																																																																						
最大力積(kN・s)	13.6	14.8	22.5	21.6	21.7	30.0																																																																																																						
最大変位(mm) ^{※1}	163	161	168	172	145	201																																																																																																						
現象時間(sec) ^{※2}	0.0156	0.0196	0.0252	0.0251	0.0652	0.0233																																																																																																						

赤字：設備、運用又は体制の相違（設計方針の相違）
 青字：記載箇所又は記載内容の相違（記載方針の相違）
 緑字：記載表現、設備名称の相違（実質的な相違なし）

第6条 外部からの衝撃による損傷の防止（竜巻：別添資料1 添付資料3.11）

大飯発電所3/4号炉	女川原子力発電所2号炉	泊発電所3号炉	相違理由
<div data-bbox="80 229 672 948" style="border: 1px solid red; padding: 5px;">  <p>(試験 SS-1：貫通) (試験 SS-2：貫通)</p> <p>(試験 SS-3：未貫通) (試験 SS-4：未貫通)</p> <p>(試験 SS-5：未貫通) (試験 SUS-1：未貫通)</p> <p>第6-1図 試験後の鋼板試験体の破壊性状</p> </div>			

赤字：設備、運用又は体制の相違（設計方針の相違）
 青字：記載箇所又は記載内容の相違（記載方針の相違）
 緑字：記載表現、設備名称の相違（実質的な相違なし）

第6条 外部からの衝撃による損傷の防止（竜巻：別添資料1 添付資料3.11）

大飯発電所3/4号炉	女川原子力発電所2号炉	泊発電所3号炉	相違理由
<div data-bbox="73 228 692 683" data-label="Image"> </div> <p data-bbox="165 643 602 667">第6-2図 試験後の柔パイプ重錘の変形状況</p> <p data-bbox="73 722 394 746">7. 試験結果によるBRL式の適用性</p> <p data-bbox="73 751 380 775">7.1 剛パイプ重錘による試験結果</p> <p data-bbox="73 780 696 951">本節では、6章に示した試験結果と第1-1図に示したBRL式から算出した貫通限界厚さとの比較より、BRL式のパラメータである飛来物直径の算定方法および材料による貫通限界厚さの低減効果を整理する。第7-1図にSS400鋼板について剛パイプ重錘の試験結果とBRL式から換算した鋼板の貫通限界厚さの関係を示す。図中に示される各曲線の説明を以下に示す。</p> <ul data-bbox="73 956 696 1182" style="list-style-type: none"> ・実線：剛パイプ重錘衝突部の接触面積と等価な面積を持つ円の直径を入力 ・一点鎖線：剛パイプ重錘衝突部の投影面積と等価な面積を持つ円の直径を入力 ・点線：剛パイプ重錘衝突部の周長と等価な周長を持つ円の直径を入力 ・破線：実線を試験SS-4の結果（左から2つ目の白丸）に基づいて補正したもの <p data-bbox="73 1217 696 1444">まず、SS400鋼板について飛来物直径を衝突部の接触面積と等価な円の直径とした場合について整理する。実線では、衝突エネルギー120kJにて必要な貫通限界厚さは13.8mmである。一方、試験SS-4（衝突エネルギー120kJ）にて板厚9mmの試験体を重錘は貫通しなかった。以上より、剛性の高い飛来物がSS400の鋼板に衝突する場合に飛来物直径を衝突部の接触面積と等価な円の直径として算定する場合は、BRL式は貫通限界厚さを約34%保守的に評価することがわかった。</p> <p data-bbox="96 1449 685 1473">次に、SUS304鋼板について飛来物直径の衝突部の接触面積と等価</p>			

赤字：設備、運用又は体制の相違（設計方針の相違）
 青字：記載箇所又は記載内容の相違（記載方針の相違）
 緑字：記載表現、設備名称の相違（実質的な相違なし）

第6条 外部からの衝撃による損傷の防止（竜巻：別添資料1 添付資料3.11）

大飯発電所3/4号炉	女川原子力発電所2号炉	泊発電所3号炉	相違理由
<p>な円の直径とした場合について整理する。補正したSS400 鋼板の貫通限界厚さを表す破線より、衝突エネルギー186kJにおける必要な貫通限界厚さは12.0mmである。一方、試験 SUS-1（衝突エネルギー186kJ）において板厚9mmの試験体が貫通しなかった。以上より、被衝突体がSUS304の場合には、算定される貫通限界厚さはSS400より約25%余裕があることがわかった。</p> <p>以上、剛パイプ重錘の試験結果よりBRL式の適用性について得られた知見は以下のとおり。</p> <p>①剛性の高い飛来物がSS400の鋼板に衝突する場合、飛来物直径を衝突部の接触面積と等価な円の直径とした場合、算定される貫通限界厚さは約34%保守的な値となる。</p> <p>②剛性の高い飛来物がSUS304鋼板に衝突する場合①で得られる補正後のSS400の貫通限界厚さ（第7-1図に示す破線）から約25%保守的な値となる。</p> <div data-bbox="78 558 694 901"> </div> <p>第7-1図 剛パイプ重錘の試験結果とBRL式から算出した鋼板の貫通限界厚さの関係</p> <p>7.2 柔パイプ重錘による試験結果</p> <p>第7-2図に柔パイプ重錘の試験結果及びBRL式から算出した鋼板の貫通限界厚さの関係を示す。剛パイプ重錘と同様に、図中で示されるBRL式の各曲線は以下のとおりである。</p> <ul style="list-style-type: none"> ・実線：柔パイプ重錘衝突部の接触面積と等価な面積を持つ円の直径を入力 ・一点鎖線：柔パイプ重錘衝突部の投影面積と等価な面積を持つ円の直径を入力 ・点線：柔パイプ重錘衝突部の周長と等価な周長を持つ円の直径を入力 <p>一点鎖線より、飛来物直径を衝突面の投影面積と等価な円の直径とした場合、衝突エネルギー182kJにおける必要な貫通限界厚さは9.0mmである。SS400鋼板に柔パイプ重錘を衝突させた試験SS-5（衝突エネルギー182kJ）では、試験体に貫通は発生しなかった。これより、自身が衝突により衝撃圧潰変形するような剛性の低い飛来物がSS400の鋼板に衝突する場合は、飛来物直径は衝突部の投影面積</p>			

赤字：設備、運用又は体制の相違（設計方針の相違）
 青字：記載箇所又は記載内容の相違（記載方針の相違）
 緑字：記載表現、設備名称の相違（実質的な相違なし）

第6条 外部からの衝撃による損傷の防止（竜巻：別添資料1 添付資料3.11）

大飯発電所3/4号炉	女川原子力発電所2号炉	泊発電所3号炉	相違理由
<p>から算定可能となることがわかった。</p> <p>以上、柔パイプ重錘の試験結果より BRL 式の適用性について得られた知見は以下のとおり。</p> <p>①衝突時に自身が衝撃圧潰変形するような剛性の低い飛来物が SS400 鋼板に衝突する場合、飛来物直径を衝突部の投影面積として貫通限界厚さを評価できる。</p> <div data-bbox="80 344 696 708" style="border: 1px solid black; padding: 5px;"> <p>第7-2図 柔パイプ重錘の試験結果と BRL 式から算出した鋼板の貫通限界厚さの関係</p> </div> <p>8. 試験結果まとめ</p> <p>7.1 章及び7.2 章に記載のとおり、試験結果より BRL 式の適用性について以下の知見が得られた。</p> <p>① 剛性の高い飛来物が SS400 の鋼板に衝突する場合、飛来物直径を衝突部の接触面積と等価な円の直径とした場合、算定される貫通限界厚さは約 34%保守的な値となる。</p> <p>② 剛性の高い飛来物が SUS304 鋼板に衝突する場合①で得られる補正後の SS400 の貫通限界厚さ（第7-1 図に示す破線）から約 25%保守的な値となる。</p> <p>③ 衝突時に自身が衝撃圧潰変形するような剛性の低い飛来物が SS400 鋼板に衝突する場合、飛来物直径を衝突部の投影面積として貫通限界厚さを評価できる。^(注1)</p> <p>（注1）別紙2 付録2 として添付する「鋼製飛来物に対する鋼板の貫通評価に関する研究（その1）衝突実験による BRL 式の検証」においても同様の知見が得られている。</p>			

赤字：設備、運用又は体制の相違（設計方針の相違）
 青字：記載箇所又は記載内容の相違（記載方針の相違）
 緑字：記載表現、設備名称の相違（実質的な相違なし）

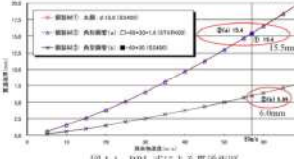
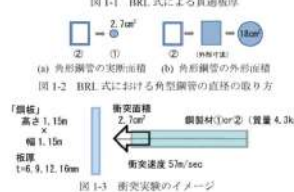
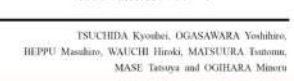
大飯発電所3/4号炉	女川原子力発電所2号炉	泊発電所3号炉	相違理由
<div data-bbox="69 231 703 1117"> <p>21554 日本原子力安全協会 別紙2付録2</p> <p>鋼製飛来物に対する鋼板の貫通評価に関する研究 (その1) 衝突実験によるBRL式の検証</p> <p>正会員 □土田裕幸¹⁾ 会員外 小笠原義清¹⁾ 正会員 別府万寿博²⁾ 正会員 和內博樹³⁾ 正会員 松浦 敦⁴⁾ 正会員 間瀬民世⁴⁾ 正会員 萩原 実⁴⁾</p> <p>BRL式 衝突面 衝突実験 飛来物 鋼板</p> <p>1-1. はじめに 飛来物の衝突が懸念される現象として、工場等の爆発事故、火山噴火、竜巻等が考えられる。これら飛来物に対する防護設計に際して、鋼板における低圧貫通評価式としては、BRL式、Jacob de Maere式、SRI式等が挙げられ、これら評価式のうちBRL式は安全側の評価を与える¹⁾。一例として、竜巻飛来物に対する防護設計では、BRL式²⁾が用いられており、BRL式では飛来物の質量、速度、直径によって鋼板の貫通径算が算出されるが、飛来物の断面形状に応じた直径の取り方についての具体的な記載はない。そこで、衝突面の形状をパラメータとして衝突実験を行い、その結果とBRL式による貫通評価を比較して、BRL式の保守性および衝突面の形状効果を検証する。あわせて、今回実施した衝突実験について、数値解析による実験再現性を検証する。 本報では衝突実験によるBRL式の検証結果を、次報(その2)、(その3)では衝突面の形状を変えた実験結果を、(その4)では衝突実験の再現解析について報告する。</p> <p>1-2. 衝突実験の目的 衝突実験の目的は以下について確認することである。 ・BRL式による貫通評価の保守性 ・貫通評価における飛来物の衝突面形状の影響 ・数値解析による鋼材衝突現象の再現性 (実験結果と再現解析結果の比較)</p> <p>1-3. 衝突実験の計画 衝突実験の条件をa)~c)に示す。 a) 飛来物として衝突面形状の異なる鋼製材①②を用いる。総質量、衝突面積はともに約4.3kg、約2.7cm²である。 鋼製材① 丸鋼 φ18.6 (SS400) 鋼製材② 角形鋼管 □=60×30×1.6 (STKR400) b) 衝突速度は竜巻影響評価ガイド³⁾に例示される鋼製材を参照し、竜巻風速100m/secでの飛来物速度57m/secを用いる。 c) 飛来物と同じ降伏耐力であるSS400の鋼板に対して飛来物を正面衝突させる。後述する図1-1に示す貫通評価により板厚t=6,9,12,16mmの鋼板を使用する。</p> <div data-bbox="380 414 672 845"> <p>以上の条件を用いたBRL式による貫通径算を図1-1に示す。鋼製材①②は、断面形状以外は同条件である。そのため、鋼製材②(角形鋼管)の直径として、突断面積と等価な円の直径(図1-2(a))を用い、鋼製材①②のBRL式による貫通径算は等しくなる。一方、図中②(b)は、鋼製材②の外断面積と等価な円の直径を用いたケース(図1-2(b))の貫通径算である。衝突実験のイメージを図1-3に、衝突実験ケースを表1-1に示す。</p> <div data-bbox="380 574 627 686"> <p>BRL式(Ballistic Research Laboratories Formula)</p> $T^2 = 0.5 \cdot M \cdot V^2 / (17400 \cdot K^2 \cdot d^2)$ <p>T: 鋼板貫通厚さ (m) M: 飛来物(飛来物)質量 (kg) V: 飛来物(飛来物)速度 (m/sec) d: 飛来物(飛来物)直径 (m) K: 鋼板の分類に関する係数 (%)</p> </div>  <p>図1-1 BRL式による貫通径算</p> </div> <div data-bbox="380 845 672 1037">  <p>図1-2 BRL式における角形鋼管の直径の取り方</p> </div> <div data-bbox="380 1037 672 1117">  <p>図1-3 衝突実験のイメージ</p> </div> <p>Research on Penetration Evaluation of Steel plate against Steel Missile by tornado (Part1) Validation of BRL formula by the Impact Test</p> <p>TSUCHIDA Kyotoku, OGASAWARA Yoshitomo, HEPPU Masahiro, WAUCHI Hiroki, MAISUURA Tutomu, MASE Tatsuya and OGHARA Minoru</p> </div>			

赤字：設備、運用又は体制の相違（設計方針の相違）
 青字：記載箇所又は記載内容の相違（記載方針の相違）
 緑字：記載表現、設備名称の相違（実質的な相違なし）

大飯発電所3/4号炉	女川原子力発電所2号炉	泊発電所3号炉	相違理由																																																																																																											
<p>表 1-1 衝突実験ケース</p> <table border="1"> <thead> <tr> <th rowspan="2">衝突実験（合計9回） ※括弧内：実験回数</th> <th colspan="4">鋼板</th> </tr> <tr> <th>鋼板 φ6mm¹⁾</th> <th>鋼板 φ9mm²⁾</th> <th>鋼板 φ12mm³⁾</th> <th>鋼板 φ16mm⁴⁾</th> </tr> </thead> <tbody> <tr> <td>飛来物 鋼製材① φ18.6</td> <td>①-1 (1回)</td> <td>①-2 (1回)</td> <td>①-3 (1回)</td> <td>①-4 (1回)</td> </tr> <tr> <td>飛来物 鋼製材② □=60×30 ×L16</td> <td>②-1 ②-2 (2回)</td> <td>②-3 (1回)</td> <td>②-4 ②-5 (2回)</td> <td>—</td> </tr> </tbody> </table> <p>※1：BRL式によるφ18.6（丸鋼）が貫通する板厚 ※2：BRL式によるφ18.6が貫通しない板厚（必要板厚） ※3：角形鋼管外形■=60×30を用いたBRL式による貫通板厚</p> <p>1-4. 衝突実験の概要 衝突実験は2014年10月23日～24日、防衛大学校、衝撃工学研究室の実験施設（圧縮空気方式による衝撃試験機 HGSR260）にて行われた。衝突実験の結果概要について表 1-2 に示す。同表には、鋼板に対する貫通の有無とBRL式による貫通板厚を併せて示す。なお、同表に示す衝突速度は飛来物射出直前の速度である。高速度ビデオカメラによる鋼板衝突直前の最大速度（次掲（その4）表 4-1 参照）はこれより増すことから、実際のところ BRL式による貫通板厚は若干厚くなる。</p> <p>表 1-2 衝突実験の結果概要</p> <table border="1"> <thead> <tr> <th>ケース</th> <th>鋼板板厚 t (mm)</th> <th>飛来物 (鋼製材②)</th> <th>貫通結果</th> <th>質量 4.3kg±10g</th> <th>衝突速度 57m/s±3%</th> <th>BRL貫通板厚 (mm)</th> <th>考査</th> </tr> </thead> <tbody> <tr> <td>①-1</td> <td>8</td> <td>φ18.6 1回打</td> <td>貫通</td> <td>4,201kg</td> <td>56.612m/s</td> <td>15.28</td> <td>BRL貫通板厚未満で貫通 →BRLの保守性</td> </tr> <tr> <td>①-2</td> <td>8</td> <td>φ18.6 1回打</td> <td>貫通</td> <td>4,209kg</td> <td>55.012m/s</td> <td>14.70</td> <td>BRL貫通板厚未満で貫通 →BRLの保守性</td> </tr> <tr> <td>①-3</td> <td>12</td> <td>φ18.6 1回打</td> <td>貫通せず</td> <td>4,299kg</td> <td>57.121m/s</td> <td>15.66</td> <td>BRL貫通板厚未満で貫通しない →BRLの保守性</td> </tr> <tr> <td>①-4</td> <td>16</td> <td>φ18.6 1回打</td> <td>貫通せず</td> <td>4,297kg</td> <td>55.374m/s</td> <td>14.82</td> <td>BRL貫通板厚以上で貫通しない →BRLの保守性</td> </tr> </tbody> </table> <table border="1"> <thead> <tr> <th>ケース</th> <th>鋼板板厚 t (mm)</th> <th>飛来物 (鋼製材②)</th> <th>貫通結果</th> <th>質量 4.3kg±10g</th> <th>衝突速度 57m/s±3%</th> <th>BRL貫通板厚 (mm)</th> <th>考査</th> </tr> </thead> <tbody> <tr> <td>②-1</td> <td>8</td> <td>□=60×30×1.8 1回打</td> <td>貫通せず</td> <td>4,209kg</td> <td>57.116m/s</td> <td>15.59</td> <td>ケース①-1との比較 →衝突形状考慮の必要性</td> </tr> <tr> <td>②-2</td> <td>8</td> <td>□=60×30×1.8 2回打</td> <td>貫通せず</td> <td>4,209kg</td> <td>57.291m/s</td> <td>15.62</td> <td>外形鋼管形状での貫通板厚で貫通しない →外形鋼管形状の保守性</td> </tr> <tr> <td>②-3</td> <td>9</td> <td>□=60×30×1.8 1回打</td> <td>貫通せず</td> <td>4,207kg</td> <td>57.812m/s</td> <td>15.67</td> <td>ケース①-2との比較 →衝突形状考慮の必要性</td> </tr> <tr> <td>②-4</td> <td>12</td> <td>□=60×30×1.8 1回打</td> <td>貫通せず</td> <td>4,208kg</td> <td>54.378m/s</td> <td>15.57</td> <td>BRL貫通板厚未満で貫通しない →BRLの保守性</td> </tr> <tr> <td>②-5</td> <td>12</td> <td>□=60×30×1.8 2回打</td> <td>貫通せず</td> <td>4,207kg</td> <td>57.484m/s</td> <td>15.62</td> <td>BRL貫通板厚未満で貫通しない →BRLの保守性</td> </tr> </tbody> </table> <p>※BRL評価について ① 貫通 BRL貫通板厚未満で貫通 ② 貫通 BRL貫通板厚未満で貫通 ③ 貫通 BRL貫通板厚未満で貫通 ④ 貫通 BRL貫通板厚未満で貫通</p> <p>*1 東北電力 *2 Tohoku Electric Power Co., Inc. *3 防衛大学校 教授・博士(工学) *4 Professor, National Defense Academy, Dr.Eng. *5 伊藤忠テクノソリューションズ *6 ITCOHI Techno-Solutions Corporation *7 東電設計 *8 Tokyo Electric Power Services Co. Ltd.</p>	衝突実験（合計9回） ※括弧内：実験回数	鋼板				鋼板 φ6mm ¹⁾	鋼板 φ9mm ²⁾	鋼板 φ12mm ³⁾	鋼板 φ16mm ⁴⁾	飛来物 鋼製材① φ18.6	①-1 (1回)	①-2 (1回)	①-3 (1回)	①-4 (1回)	飛来物 鋼製材② □=60×30 ×L16	②-1 ②-2 (2回)	②-3 (1回)	②-4 ②-5 (2回)	—	ケース	鋼板板厚 t (mm)	飛来物 (鋼製材②)	貫通結果	質量 4.3kg±10g	衝突速度 57m/s±3%	BRL貫通板厚 (mm)	考査	①-1	8	φ18.6 1回打	貫通	4,201kg	56.612m/s	15.28	BRL貫通板厚未満で貫通 →BRLの保守性	①-2	8	φ18.6 1回打	貫通	4,209kg	55.012m/s	14.70	BRL貫通板厚未満で貫通 →BRLの保守性	①-3	12	φ18.6 1回打	貫通せず	4,299kg	57.121m/s	15.66	BRL貫通板厚未満で貫通しない →BRLの保守性	①-4	16	φ18.6 1回打	貫通せず	4,297kg	55.374m/s	14.82	BRL貫通板厚以上で貫通しない →BRLの保守性	ケース	鋼板板厚 t (mm)	飛来物 (鋼製材②)	貫通結果	質量 4.3kg±10g	衝突速度 57m/s±3%	BRL貫通板厚 (mm)	考査	②-1	8	□=60×30×1.8 1回打	貫通せず	4,209kg	57.116m/s	15.59	ケース①-1との比較 →衝突形状考慮の必要性	②-2	8	□=60×30×1.8 2回打	貫通せず	4,209kg	57.291m/s	15.62	外形鋼管形状での貫通板厚で貫通しない →外形鋼管形状の保守性	②-3	9	□=60×30×1.8 1回打	貫通せず	4,207kg	57.812m/s	15.67	ケース①-2との比較 →衝突形状考慮の必要性	②-4	12	□=60×30×1.8 1回打	貫通せず	4,208kg	54.378m/s	15.57	BRL貫通板厚未満で貫通しない →BRLの保守性	②-5	12	□=60×30×1.8 2回打	貫通せず	4,207kg	57.484m/s	15.62	BRL貫通板厚未満で貫通しない →BRLの保守性	<p>丸鋼を用いた①-3は、BRL式による貫通板厚未満の鋼板であったが、実験では貫通しなかった。本ケースより、衝突断面の飛来物に対してBRL式が保守的な結果を示すことがわかる。また、①-1と②-2、①-2と②-3をそれぞれ比較すると、飛来物断面形状の違いが貫通有無に影響し、かつ②-1.2によると、角型鋼管のような中空断面飛来物においては、BRL貫通評価における直径の設定に関して、飛来物の外形面積を用いる方が実験結果と整合する結果が得られた。</p> <p>1-5. まとめ 今回の衝突実験から、鋼板の既往貫通評価式であるBRL式には保守性があり、飛来物の断面形状を考慮する必要があることを確認した。また、飛来物直径の設定に関して、角型鋼管のような中空断面の場合は、外形寸法を基準として直径を設定する方が実験結果と整合することが分かった。</p> <p>【参考文献】 1) 大寺 祐、吉沢弘幸、千葉昭正、志田茂「飛来物に対する鋼板の耐衝撃性」第2報、鋼板の破損現象エネルギー評価(六)日本機械学会論文集(編)第421号、pp.1373-1379、昭和59年12月 2) 3030760-4「株式会社日立製作所の発明に係る速度センサーの構造」特許庁の審判による特許権の取消の請求に対する裁量、その3 ミニマルの審査による特許権の取消に関する特許法の比較検討（高速度衝突安全技術研究会）第9号（平成15年） 3) 原子力発電所の地震影響評価ガイド（国定、平成25年6月19日、原研技報第13061911号、原子力規制委員会決定）</p>		
衝突実験（合計9回） ※括弧内：実験回数		鋼板																																																																																																												
	鋼板 φ6mm ¹⁾	鋼板 φ9mm ²⁾	鋼板 φ12mm ³⁾	鋼板 φ16mm ⁴⁾																																																																																																										
飛来物 鋼製材① φ18.6	①-1 (1回)	①-2 (1回)	①-3 (1回)	①-4 (1回)																																																																																																										
飛来物 鋼製材② □=60×30 ×L16	②-1 ②-2 (2回)	②-3 (1回)	②-4 ②-5 (2回)	—																																																																																																										
ケース	鋼板板厚 t (mm)	飛来物 (鋼製材②)	貫通結果	質量 4.3kg±10g	衝突速度 57m/s±3%	BRL貫通板厚 (mm)	考査																																																																																																							
①-1	8	φ18.6 1回打	貫通	4,201kg	56.612m/s	15.28	BRL貫通板厚未満で貫通 →BRLの保守性																																																																																																							
①-2	8	φ18.6 1回打	貫通	4,209kg	55.012m/s	14.70	BRL貫通板厚未満で貫通 →BRLの保守性																																																																																																							
①-3	12	φ18.6 1回打	貫通せず	4,299kg	57.121m/s	15.66	BRL貫通板厚未満で貫通しない →BRLの保守性																																																																																																							
①-4	16	φ18.6 1回打	貫通せず	4,297kg	55.374m/s	14.82	BRL貫通板厚以上で貫通しない →BRLの保守性																																																																																																							
ケース	鋼板板厚 t (mm)	飛来物 (鋼製材②)	貫通結果	質量 4.3kg±10g	衝突速度 57m/s±3%	BRL貫通板厚 (mm)	考査																																																																																																							
②-1	8	□=60×30×1.8 1回打	貫通せず	4,209kg	57.116m/s	15.59	ケース①-1との比較 →衝突形状考慮の必要性																																																																																																							
②-2	8	□=60×30×1.8 2回打	貫通せず	4,209kg	57.291m/s	15.62	外形鋼管形状での貫通板厚で貫通しない →外形鋼管形状の保守性																																																																																																							
②-3	9	□=60×30×1.8 1回打	貫通せず	4,207kg	57.812m/s	15.67	ケース①-2との比較 →衝突形状考慮の必要性																																																																																																							
②-4	12	□=60×30×1.8 1回打	貫通せず	4,208kg	54.378m/s	15.57	BRL貫通板厚未満で貫通しない →BRLの保守性																																																																																																							
②-5	12	□=60×30×1.8 2回打	貫通せず	4,207kg	57.484m/s	15.62	BRL貫通板厚未満で貫通しない →BRLの保守性																																																																																																							

赤字：設備、運用又は体制の相違（設計方針の相違）
 青字：記載箇所又は記載内容の相違（記載方針の相違）
 緑字：記載表現、設備名称の相違（実質的な相違なし）

第6条 外部からの衝撃による損傷の防止（竜巻：別添資料1 添付資料3.11）

大飯発電所3/4号炉	女川原子力発電所2号炉	泊発電所3号炉	相違理由																		
<p style="text-align: center;">別紙2 付録3</p> <p>電力中央研究所報告「竜巻飛来物を模擬した重錘の鋼板上への自由落下衝突試験による鋼板貫通評価手法の提案」の成果を踏まえたディーゼル発電機室水密扉の貫通評価の考え方について</p> <p>1. 概要</p> <p>ディーゼル発電機室の水密扉（以下、DG水密扉という。）について、設計飛来物の衝突により貫通した場合に飛来物がディーゼル発電機の付属設備に衝突する可能性を否定できないことから、DG水密扉に対して竜巻防護施設を内包する施設としての健全性を確認するために設計飛来物の貫通評価を別紙2にて行っている。</p> <p>本資料は、電力中央研究所報告「竜巻飛来物を模擬した重錘の鋼板上への自由落下衝突試験による鋼板貫通評価手法の提案」（以下、電中研成果という。）で得られた知見をどのように貫通評価へ適用したかを記載する。</p> <p>2. BRL 式について</p> <p>鋼板に対する既往の貫通評価式であるBRL 式を式(1)に示す。また、BRL 式における記号の定義を第2-1表に、大飯発電所の設計飛来物の諸元を第2-2表に示す。</p> <p>大飯発電所の設計飛来物である鋼製材の諸元からBRL 式における入力値である設計飛来物の質量M=135kg及び設計飛来物の水平最大速度V=57m/sとなる。その他、設計飛来物が衝突する衝突断面の等価直径d及び鋼板の材質に関する係数Kを入力する必要があり、これらの入力値に関して電中研成果を用いることとする。</p> <div style="border: 1px solid black; padding: 10px; margin: 10px 0;"> $T^{\frac{3}{2}} = \frac{0.5 \cdot M \cdot V^2}{1.4396 \times 10^9 \cdot K^2 \cdot d^3} \quad (1)$ </div> <p style="text-align: center;">第2-1表 BRL式における記号の定義</p> <table border="1" style="width: 100%; border-collapse: collapse;"> <thead> <tr> <th>記号</th> <th>単位</th> <th>定義</th> </tr> </thead> <tbody> <tr> <td>d</td> <td>m</td> <td>設計飛来物が衝突する衝突断面の等価直径</td> </tr> <tr> <td>K</td> <td>—</td> <td>鋼板の材質に関する係数</td> </tr> <tr> <td>M</td> <td>kg</td> <td>設計飛来物の質量</td> </tr> <tr> <td>T</td> <td>m</td> <td>貫通限界厚さ</td> </tr> <tr> <td>V</td> <td>m/s</td> <td>設計飛来物の最大水平速度</td> </tr> </tbody> </table>	記号	単位	定義	d	m	設計飛来物が衝突する衝突断面の等価直径	K	—	鋼板の材質に関する係数	M	kg	設計飛来物の質量	T	m	貫通限界厚さ	V	m/s	設計飛来物の最大水平速度			
記号	単位	定義																			
d	m	設計飛来物が衝突する衝突断面の等価直径																			
K	—	鋼板の材質に関する係数																			
M	kg	設計飛来物の質量																			
T	m	貫通限界厚さ																			
V	m/s	設計飛来物の最大水平速度																			

赤字：設備、運用又は体制の相違（設計方針の相違）
 青字：記載箇所又は記載内容の相違（記載方針の相違）
 緑字：記載表現、設備名称の相違（実質的な相違なし）

第6条 外部からの衝撃による損傷の防止（竜巻：別添資料1 添付資料3.11）

大阪発電所3/4号炉	女川原子力発電所2号炉	泊発電所3号炉	相違理由										
<div data-bbox="85 225 689 368" style="border: 1px solid black; padding: 5px;"> <p style="text-align: center;">第2-2表 大阪発電所の設計飛来物の諸元</p> <table border="1" style="width: 100%; border-collapse: collapse;"> <thead> <tr> <th>設計飛来物</th> <th>長さ×幅×奥行き (m)</th> <th>質量 (kg)</th> <th>最大水平速度 (m/s)</th> <th>最大鉛直速度 (m/s)</th> </tr> </thead> <tbody> <tr> <td>鋼製材</td> <td>4.2×0.3×0.2</td> <td>135</td> <td>57</td> <td>38</td> </tr> </tbody> </table> </div> <p>3. 電中研成果及びD/G水密扉貫通評価への適用について 電中研成果で得られた知見は以下のとおりである。以下に知見について、第3-1表に整理する。</p> <p>① 剛性の高い飛来物がSS400の鋼板に衝突する場合、SS400鋼板の貫通限界厚さは飛来物直径を衝突部の接触面積と等価な円の直径とした場合にBRL式より算定される貫通限界厚さから約34%低減できる。 →BRL式における鋼板の材質に関する係数Kに関する知見</p> <p>② 剛性の高い飛来物がSUS304鋼板に衝突する場合①で得られる補正後のSS400の貫通限界厚さから約25%低減できる。 →BRL式における鋼板の材質に関する係数Kに関する知見</p> <p>③ 衝突時に自身が衝撃圧潰変形するような剛性の低い飛来物がSS400鋼板に衝突する場合、飛来物直径を衝突部の投影面積と等価な円の直径として貫通限界厚さを評価できる。 →BRL式における設計飛来物が衝突する衝突断面の等価直径dに関する知見</p> <p>また、大阪発電所の設計飛来物は、長さ4,200mm×幅300mm×奥行き200mm、厚み4.2mm、質量135kgであり、被衝突体である水密扉は幅5640mm×高さ4975mm、厚み11mm(表板2mm+裏板9mm)である。これらについて、第3-2表に整理する。</p> <div data-bbox="85 1010 689 1425" style="border: 1px solid black; padding: 5px; margin-top: 20px;"> <p>整理結果より、大阪発電所の設計飛来物については、電中研成果における柔パイプの断面形状とはほぼ同等であり、貫通評価においては、③の等価直径dに関する知見の適用が可であることが分かる。</p> <div style="border: 1px solid black; height: 40px; width: 100%; margin-top: 10px;"></div> <div style="border: 1px solid black; padding: 2px; text-align: center; margin-top: 10px; font-size: small;"> 枠囲みの範囲は機密に係る事項ですので公開することはできません。 </div> </div>	設計飛来物	長さ×幅×奥行き (m)	質量 (kg)	最大水平速度 (m/s)	最大鉛直速度 (m/s)	鋼製材	4.2×0.3×0.2	135	57	38			
設計飛来物	長さ×幅×奥行き (m)	質量 (kg)	最大水平速度 (m/s)	最大鉛直速度 (m/s)									
鋼製材	4.2×0.3×0.2	135	57	38									

赤字：設備、運用又は体制の相違（設計方針の相違）
 青字：記載箇所又は記載内容の相違（記載方針の相違）
 緑字：記載表現、設備名称の相違（実質的な相違なし）

第6条 外部からの衝撃による損傷の防止（竜巻：別添資料1 添付資料3.11）

大飯発電所3/4号炉	女川原子力発電所2号炉	泊発電所3号炉	相違理由																					
<p style="text-align: center;">第3-1表 電中研究成果より得られた知見</p> <table border="1" data-bbox="85 252 689 481"> <thead> <tr> <th>飛来物（柔・剛）</th> <th>被衝突体</th> <th>得られた知見</th> </tr> </thead> <tbody> <tr> <td>① 剛パイプ重錘（衝突断面形状 250mm×250mm×t16）</td> <td>材質：SS400 サイズ：幅 1400mm×幅 1400mm×t9mm</td> <td>BRL式において飛来物直径を接触面積と等価な円の直径とした場合、貫通限界厚さは約34%低減できる。</td> </tr> <tr> <td>② 剛パイプ重錘（衝突断面形状 250mm×250mm×t16）</td> <td>材質：SUS304 サイズ：幅 1400mm×幅 1400mm×t9mm</td> <td>①のSS400の貫通限界厚さから約25%低減できる。</td> </tr> <tr> <td>③ 柔パイプ重錘（衝突断面形状 250mm×250mm×t4.5）</td> <td>材質：SS400 サイズ：幅 1400mm×幅 1400mm×t9mm</td> <td>飛来物直径を衝突部の投影面積と等価な円の直径として貫通限界厚さを評価できる。</td> </tr> </tbody> </table> <p style="text-align: center;">第3-2表 大飯発電所の設計飛来物である鋼製材及び被衝突体である水密扉の仕様</p> <table border="1" data-bbox="85 555 689 721"> <thead> <tr> <th>評価対象</th> <th>仕様</th> <th>適用可能な知見</th> </tr> </thead> <tbody> <tr> <td>設計飛来物</td> <td>鋼製材 衝突断面形状：300mm×200mm×14.2mm</td> <td>衝突断面形状が電中研究成果における柔パイプ相当であり、③の知見を適用可</td> </tr> <tr> <td>被衝突体</td> <td>DG水密扉</td> <td style="background-color: black; color: black;">[Redacted]</td> </tr> </tbody> </table> <p style="text-align: center; border: 1px solid black; padding: 2px;">情報の範囲は機密に係る事項ですので公開することはできません。</p>	飛来物（柔・剛）	被衝突体	得られた知見	① 剛パイプ重錘（衝突断面形状 250mm×250mm×t16）	材質：SS400 サイズ：幅 1400mm×幅 1400mm×t9mm	BRL式において飛来物直径を接触面積と等価な円の直径とした場合、貫通限界厚さは約34%低減できる。	② 剛パイプ重錘（衝突断面形状 250mm×250mm×t16）	材質：SUS304 サイズ：幅 1400mm×幅 1400mm×t9mm	①のSS400の貫通限界厚さから約25%低減できる。	③ 柔パイプ重錘（衝突断面形状 250mm×250mm×t4.5）	材質：SS400 サイズ：幅 1400mm×幅 1400mm×t9mm	飛来物直径を衝突部の投影面積と等価な円の直径として貫通限界厚さを評価できる。	評価対象	仕様	適用可能な知見	設計飛来物	鋼製材 衝突断面形状：300mm×200mm×14.2mm	衝突断面形状が電中研究成果における柔パイプ相当であり、③の知見を適用可	被衝突体	DG水密扉	[Redacted]			
飛来物（柔・剛）	被衝突体	得られた知見																						
① 剛パイプ重錘（衝突断面形状 250mm×250mm×t16）	材質：SS400 サイズ：幅 1400mm×幅 1400mm×t9mm	BRL式において飛来物直径を接触面積と等価な円の直径とした場合、貫通限界厚さは約34%低減できる。																						
② 剛パイプ重錘（衝突断面形状 250mm×250mm×t16）	材質：SUS304 サイズ：幅 1400mm×幅 1400mm×t9mm	①のSS400の貫通限界厚さから約25%低減できる。																						
③ 柔パイプ重錘（衝突断面形状 250mm×250mm×t4.5）	材質：SS400 サイズ：幅 1400mm×幅 1400mm×t9mm	飛来物直径を衝突部の投影面積と等価な円の直径として貫通限界厚さを評価できる。																						
評価対象	仕様	適用可能な知見																						
設計飛来物	鋼製材 衝突断面形状：300mm×200mm×14.2mm	衝突断面形状が電中研究成果における柔パイプ相当であり、③の知見を適用可																						
被衝突体	DG水密扉	[Redacted]																						

赤字：設備，運用又は体制の相違（設計方針の相違）
 青字：記載箇所又は記載内容の相違（記載方針の相違）
 緑字：記載表現，設備名称の相違（実質的な相違なし）

第6条 外部からの衝撃による損傷の防止（竜巻：別添資料1 添付資料3.11）

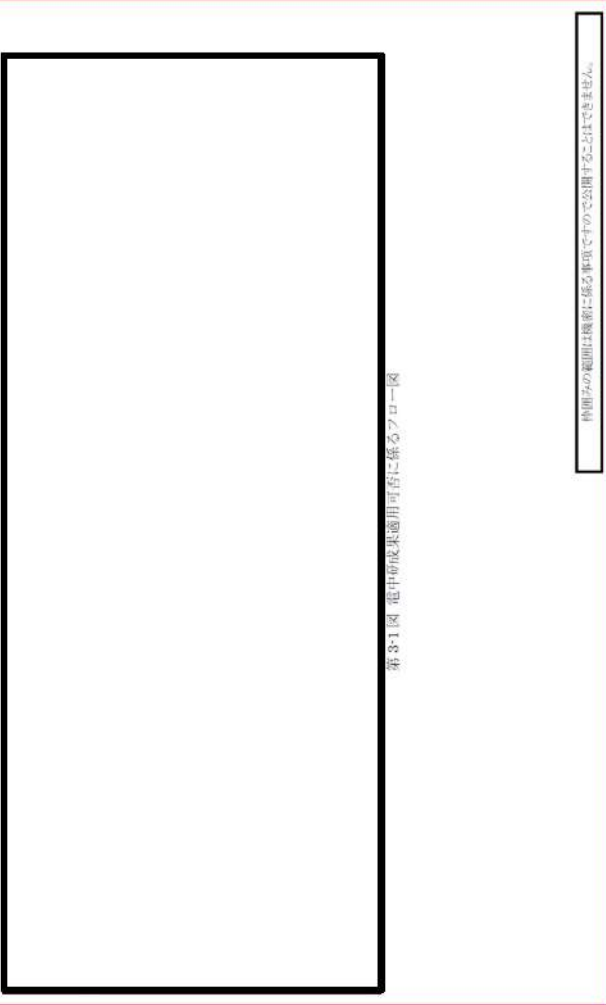
大飯発電所3/4号炉	女川原子力発電所2号炉	泊発電所3号炉	相違理由
<div data-bbox="85 229 689 1238" style="border: 1px solid black; padding: 10px;">  <p style="writing-mode: vertical-rl; position: absolute; right: 10px; top: 50%; transform: translateY(-50%);">図8-1 竜巻荷重適用可否に係るフロー図</p> </div> <p style="font-size: small; margin-top: 10px;">4. BRL 式における入力値について (1) 衝突速度 V 及び飛来物質量 M について 第 2-2 表の大飯発電所の設計飛来物である鋼製材の諸元から BRL 式における入力値である設計飛来物の質量 M=135kg 及び設計飛来物の水平最大速度 V=57m/s となる。 (2) 設計飛来物が衝突する衝突断面の等価直径 d について 設計飛来物が衝突する衝突断面の等価直径 d については、電中研</p>			

赤字：設備、運用又は体制の相違（設計方針の相違）
 青字：記載箇所又は記載内容の相違（記載方針の相違）
 緑字：記載表現、設備名称の相違（実質的な相違なし）

第6条 外部からの衝撃による損傷の防止（竜巻：別添資料1 添付資料3.11）

大飯発電所3/4号炉	女川原子力発電所2号炉	泊発電所3号炉	相違理由																				
<p>成果における等価直径 d に関する知見③を用いる。 設計飛来物が衝突する衝突断面の等価直径として、設計飛来物である鋼製材の衝突断面において最も面積が小さい $0.3\text{m} \times 0.2\text{m} = 0.06\text{m}^2$ の面が被衝突体である水密扉に衝突することを想定し、知見③を適用し、この投影面積と等価円の直径は $0.06\text{m}^2 = \pi \times d^2 / 4$ より、$d = 0.276\text{m}$ となる。</p> <p>(3) 鋼板の材質に関する係数 K について</p> <div style="border: 1px solid black; height: 80px; width: 100%;"></div> <p>(4) 評価における保守性について</p> <div style="border: 1px solid black; height: 150px; width: 100%;"></div> <div style="border: 1px solid black; padding: 2px; text-align: center; margin-top: 10px;"> 枠囲みの範囲は機密に係る事項ですので公開することはできません。 </div> <p>5. 結論 以上より、大飯3、4号機DG水密扉に対する評価については、電中研究成果における設計飛来物が衝突する衝突断面の等価直径 d に関する知見③のみ用いることとし、別紙2に記載しているDG水密扉に対する既往の貫通評価式(BRL式)における入力値は以下の第5-1表とする。</p> <table border="1" style="width: 100%; border-collapse: collapse;"> <caption>第5-1表 DG水密扉に対する既往の貫通評価式(BRL式)における入力値</caption> <thead> <tr> <th>記号</th> <th>定義</th> <th>数値</th> <th>単位</th> </tr> </thead> <tbody> <tr> <td>d</td> <td>設計飛来物が衝突する衝突断面の等価直径</td> <td>0.276</td> <td>m</td> </tr> <tr> <td>K</td> <td>鋼板の材質に関する係数</td> <td>1</td> <td>-</td> </tr> <tr> <td>M</td> <td>設計飛来物の質量</td> <td>135</td> <td>kg</td> </tr> <tr> <td>V</td> <td>設計飛来物の最大水平速度</td> <td>57</td> <td>m/s</td> </tr> </tbody> </table>	記号	定義	数値	単位	d	設計飛来物が衝突する衝突断面の等価直径	0.276	m	K	鋼板の材質に関する係数	1	-	M	設計飛来物の質量	135	kg	V	設計飛来物の最大水平速度	57	m/s			
記号	定義	数値	単位																				
d	設計飛来物が衝突する衝突断面の等価直径	0.276	m																				
K	鋼板の材質に関する係数	1	-																				
M	設計飛来物の質量	135	kg																				
V	設計飛来物の最大水平速度	57	m/s																				

赤字：設備、運用又は体制の相違（設計方針の相違）
 青字：記載箇所又は記載内容の相違（記載方針の相違）
 緑字：記載表現、設備名称の相違（実質的な相違なし）

第6条 外部からの衝撃による損傷の防止（竜巻：別添資料1 添付資料3.11）

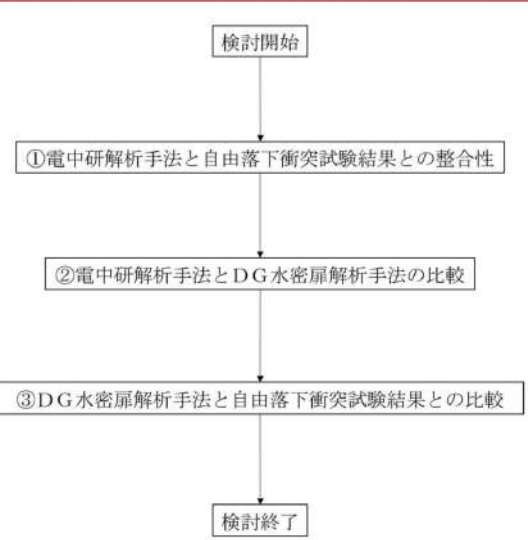
大飯発電所3/4号炉	女川原子力発電所2号炉	泊発電所3号炉	相違理由
<p style="text-align: center;">別紙2 付録4</p> <p style="text-align: center;">DG水密扉の飛来物衝突解析手法の保守性について</p> <p>1. 概要</p> <p>別紙2において、DG水密扉に対して、3次元FEMモデルを用いた飛来物衝突評価を実施しており、本評価は、電力中央研究所報告「竜巻飛来物を模擬した重錘の鋼板上への自由落下衝突試験による鋼板貫通評価手法の提案」（以下、電中研報告という）において実施している重錘の自由落下衝突試験のための事前解析の解析手法を参考に実施している。</p> <p>本資料においては、「電中研報告における解析手法（以下、電中研解析手法という）が重錘の自由落下衝突試験結果と整合していること」、「別紙2に記載のDG水密扉の飛来物衝突解析手法（以下、DG水密扉解析手法という）の保守性」について記載する。これらに係る評価フローを第1-1図に示す。</p> <div style="border: 1px solid black; padding: 10px; margin: 10px 0;">  <pre> graph TD A[検討開始] --> B[①電中研解析手法と自由落下衝突試験結果との整合性] B --> C[②電中研解析手法とDG水密扉解析手法の比較] C --> D[③DG水密扉解析手法と自由落下衝突試験結果との比較] D --> E[検討終了] </pre> <p>第1-1図 DG水密扉解析手法の保守性に関する評価フロー</p> </div> <p>2. 電中研解析手法と自由落下衝突試験結果との整合性について</p> <p>(1) 事前解析における塑性ひずみ及び試験結果における貫通有無について</p> <p>電中研報告においては、事前解析にて得られた衝突エネルギーと鋼</p>			

赤字：設備、運用又は体制の相違（設計方針の相違）
 青字：記載箇所又は記載内容の相違（記載方針の相違）
 緑字：記載表現、設備名称の相違（実質的な相違なし）

第6条 外部からの衝撃による損傷の防止（竜巻：別添資料1 添付資料3.11）

大飯発電所3/4号炉	女川原子力発電所2号炉	泊発電所3号炉	相違理由																																																			
<p>板に発生する相当塑性ひずみの関係を求め、試験の重錘落下高さに反映を行っている。その際に得られた事前解析結果による相当塑性ひずみと自由落下衝突試験における貫通有無の関係を第2-1表に示す。</p> <div data-bbox="73 247 703 486" style="border: 1px solid black; padding: 5px;"> <p>第2-1表 事前解析結果による相当塑性ひずみと自由落下衝突試験における貫通有無</p> <table border="1"> <thead> <tr> <th rowspan="2">試験（解析）ケース</th> <th colspan="3">試験条件</th> <th rowspan="2">実験結果による貫通有無</th> <th rowspan="2">事前解析で得られた相当塑性ひずみ(%)</th> </tr> <tr> <th>飛来物</th> <th>被衝突体^{※1}</th> <th>落下高さ(m)</th> </tr> </thead> <tbody> <tr> <td>SS-1</td> <td>剛パイプ重錘</td> <td>SS400</td> <td>17.0</td> <td>有</td> <td>17.4</td> </tr> <tr> <td>SS-2</td> <td>剛パイプ重錘</td> <td>SS400</td> <td>12.5</td> <td>有</td> <td>14.9</td> </tr> <tr> <td>SS-4</td> <td>剛パイプ重錘</td> <td>SS400</td> <td>11</td> <td>無</td> <td>14.1</td> </tr> <tr> <td>SS-3</td> <td>剛パイプ重錘</td> <td>SS400</td> <td>9.5</td> <td>無</td> <td>13.0</td> </tr> </tbody> </table> <p>※1：有効開口部サイズ1.4m×1.4m×t9mm、接続部2辺固定</p> <p>上記の試験結果及び事前解析結果より、試験ケース SS-2 においては、貫通が発生しており、事前解析により得られた相当塑性ひずみは、14.9%である。また、試験ケース SS-4 においては、貫通が発生しておらず、事前解析により得られた相当塑性ひずみは、14.1%である。したがって、試験結果及び事前解析結果より、<u>SS400 鋼板については、相当塑性ひずみが 14.1%～14.9%の間で貫通が発生することが考えられる。</u></p> <p>(2) SS400 鋼板の引張試験における塑性ひずみについて 以下の第2-2表に自由落下試験に用いた SS400 鋼板の引張試験で得られた材料特性値を示す。ここで、試験に使用した被衝突体である SS400 鋼板の材料試験値から得られた引張ひずみに相当する塑性ひずみが 14.9%であることから、<u>被衝突体である SS400 鋼板の塑性ひずみが 14.9%付近に達した場合に飛来物が貫通することが考えられる。</u></p> <div data-bbox="73 957 703 1117" style="border: 1px solid black; padding: 5px;"> <p>第2-2表 自由落下試験に用いた SS400 鋼板の材料試験値他</p> <table border="1"> <thead> <tr> <th rowspan="2">部材</th> <th colspan="4">材料試験結果（平均値）</th> <th rowspan="2">引張ひずみを真ひずみに換算した値(%)</th> <th rowspan="2">塑性ひずみ（左記から弾性ひずみを差し引いた値）</th> </tr> <tr> <th>降伏応力 (MPa)</th> <th>引張強さ (MPa)</th> <th>引張ひずみ(%)</th> <th>ヤング率(GPa)</th> </tr> </thead> <tbody> <tr> <td>鋼板(SS400)</td> <td>322.3</td> <td>474.4</td> <td>0.1624</td> <td>209.7</td> <td>0.151</td> <td>0.149</td> </tr> </tbody> </table> </div> <p>(3) 電中研解析手法及び自由落下衝突試験結果と材料試験値の整合性 (1) により事前解析における相当塑性ひずみと自由落下衝突試験における貫通有無より、飛来物衝突により発生する SS400 鋼板の相当塑性ひずみが 14.1～14.9%に達した場合に貫通することが考えられること、(2) の SS400 鋼板の引張試験における材料試験値より SS400 鋼板の塑性ひずみが 14.9%であることから、電中研報告における事前解析及び自由落下衝突試験結果は材料試験結果とよく整合していることが確認できる。 したがって、電中研解析手法は自由落下衝突試験結果とよく整合している解析手法であるといえる。以下の第2-3表に電中研報告にお</p> </div>	試験（解析）ケース	試験条件			実験結果による貫通有無	事前解析で得られた相当塑性ひずみ(%)	飛来物	被衝突体 ^{※1}	落下高さ(m)	SS-1	剛パイプ重錘	SS400	17.0	有	17.4	SS-2	剛パイプ重錘	SS400	12.5	有	14.9	SS-4	剛パイプ重錘	SS400	11	無	14.1	SS-3	剛パイプ重錘	SS400	9.5	無	13.0	部材	材料試験結果（平均値）				引張ひずみを真ひずみに換算した値(%)	塑性ひずみ（左記から弾性ひずみを差し引いた値）	降伏応力 (MPa)	引張強さ (MPa)	引張ひずみ(%)	ヤング率(GPa)	鋼板(SS400)	322.3	474.4	0.1624	209.7	0.151	0.149			
試験（解析）ケース		試験条件					実験結果による貫通有無	事前解析で得られた相当塑性ひずみ(%)																																														
	飛来物	被衝突体 ^{※1}	落下高さ(m)																																																			
SS-1	剛パイプ重錘	SS400	17.0	有	17.4																																																	
SS-2	剛パイプ重錘	SS400	12.5	有	14.9																																																	
SS-4	剛パイプ重錘	SS400	11	無	14.1																																																	
SS-3	剛パイプ重錘	SS400	9.5	無	13.0																																																	
部材	材料試験結果（平均値）				引張ひずみを真ひずみに換算した値(%)	塑性ひずみ（左記から弾性ひずみを差し引いた値）																																																
	降伏応力 (MPa)	引張強さ (MPa)	引張ひずみ(%)	ヤング率(GPa)																																																		
鋼板(SS400)	322.3	474.4	0.1624	209.7	0.151	0.149																																																

赤字：設備、運用又は体制の相違（設計方針の相違）
 青字：記載箇所又は記載内容の相違（記載方針の相違）
 緑字：記載表現、設備名称の相違（実質的な相違なし）

第6条 外部からの衝撃による損傷の防止（竜巻：別添資料1 添付資料3.11）

大飯発電所3/4号炉	女川原子力発電所2号炉	泊発電所3号炉	相違理由						
<p>ける事前解析、自由落下衝突試験及び材料試験から得られた結果を示す。</p> <table border="1" data-bbox="80 228 689 411"> <caption>第2-3表 電中研報告における事前解析、自由落下衝突試験及び材料試験から得られた結果</caption> <thead> <tr> <th>事前解析及び自由落下衝突試験から得られた結果</th> <th>材料試験から得られた結果</th> <th>結論</th> </tr> </thead> <tbody> <tr> <td>SS400鋼板については、飛来物衝突により相当塑性ひずみが14.1%～14.9%に達した場合に貫通する。</td> <td>自由落下衝突試験に使用したSS400鋼板の引張ひずみに相当する塑性ひずみが14.3%</td> <td>左記より電中研解析手法は自由落下衝突試験結果とよく整合しているといえる。</td> </tr> </tbody> </table> <p>3. 電中研解析手法とDG水密扉解析手法の比較について 電中研解析手法とDG水密扉解析手法の比較を第3-1表に示す。本比較表より、DG水密扉解析手法については、「静的な物性値の出典」及び「破断ひずみ（破断条件）」において、保守性を有しており、その他については、差異がないことからDG水密扉解析手法は電中研解析手法に比べ保守性を有しているといえる。</p>	事前解析及び自由落下衝突試験から得られた結果	材料試験から得られた結果	結論	SS400鋼板については、飛来物衝突により相当塑性ひずみが14.1%～14.9%に達した場合に貫通する。	自由落下衝突試験に使用したSS400鋼板の引張ひずみに相当する塑性ひずみが14.3%	左記より電中研解析手法は自由落下衝突試験結果とよく整合しているといえる。			
事前解析及び自由落下衝突試験から得られた結果	材料試験から得られた結果	結論							
SS400鋼板については、飛来物衝突により相当塑性ひずみが14.1%～14.9%に達した場合に貫通する。	自由落下衝突試験に使用したSS400鋼板の引張ひずみに相当する塑性ひずみが14.3%	左記より電中研解析手法は自由落下衝突試験結果とよく整合しているといえる。							

赤字：設備、運用又は体制の相違（設計方針の相違）
 青字：記載箇所又は記載内容の相違（記載方針の相違）
 緑字：記載表現、設備名称の相違（実質的な相違なし）

第6条 外部からの衝撃による損傷の防止（竜巻：別添資料1 添付資料3.11）

大阪発電所3/4号炉	女川原子力発電所2号炉	泊発電所3号炉	相違理由																																			
<p> それぞれ鋼板及び重錘の応力-ひずみ線図、第4-4図～第4-7図にSS-1～SS-4のケースにおけるミーゼス応力最大値の時刻歴、第4-8図にSS-4のケースの解析終了時におけるミーゼス応力分布図を示す。解析モデルは電中研試験と同様2辺固定とし、重錘部については、密度を大きくした要素を採用することで重錘の重量を模擬している。 </p> <div style="border: 1px solid black; padding: 5px; margin: 10px 0;"> <p style="text-align: center;">第4-1表 DG水密部解析手法による自由落下衝突試験の追解析</p> <table border="1" style="width: 100%; border-collapse: collapse;"> <thead> <tr> <th rowspan="2">試験ケース</th> <th colspan="3">試験条件</th> <th rowspan="2">実験結果による貫通有無(残留速度(m/s))</th> <th rowspan="2">DG水密部解析手法を用いた追解析による貫通有無(残留速度(m/s))</th> </tr> <tr> <th>飛来物</th> <th>被衝突体</th> <th>落下高さ(m)</th> </tr> </thead> <tbody> <tr> <td>SS-1</td> <td>剛パイプ重錘</td> <td>SS400</td> <td>17</td> <td>有(8.5m/s)</td> <td rowspan="5" style="background-color: black; color: black;">[Redacted]</td> </tr> <tr> <td>SS-2</td> <td>剛パイプ重錘</td> <td>SS400</td> <td>12.5</td> <td>有(2.9m/s)</td> </tr> <tr> <td>SS-4</td> <td>剛パイプ重錘</td> <td>SS400</td> <td>11</td> <td>無</td> </tr> <tr> <td>SS-3</td> <td>剛パイプ重錘</td> <td>SS400</td> <td>9.5</td> <td>無</td> </tr> <tr> <td></td> <td></td> <td></td> <td></td> <td></td> </tr> </tbody> </table> </div> <div style="border: 1px solid black; width: 200px; height: 200px; margin: 10px 0; margin-left: 20px;"> </div> <p style="text-align: center;">第4-1図 解析モデル(1/4 対称モデル)</p> <div style="border: 1px solid black; padding: 2px; margin: 10px 0; margin-left: 20px;"> <p>特開みの範囲は機密に係る事項ですので公開することはできません。</p> </div>	試験ケース	試験条件			実験結果による貫通有無(残留速度(m/s))	DG水密部解析手法を用いた追解析による貫通有無(残留速度(m/s))	飛来物	被衝突体	落下高さ(m)	SS-1	剛パイプ重錘	SS400	17	有(8.5m/s)	[Redacted]	SS-2	剛パイプ重錘	SS400	12.5	有(2.9m/s)	SS-4	剛パイプ重錘	SS400	11	無	SS-3	剛パイプ重錘	SS400	9.5	無								
試験ケース		試験条件					実験結果による貫通有無(残留速度(m/s))	DG水密部解析手法を用いた追解析による貫通有無(残留速度(m/s))																														
	飛来物	被衝突体	落下高さ(m)																																			
SS-1	剛パイプ重錘	SS400	17	有(8.5m/s)	[Redacted]																																	
SS-2	剛パイプ重錘	SS400	12.5	有(2.9m/s)																																		
SS-4	剛パイプ重錘	SS400	11	無																																		
SS-3	剛パイプ重錘	SS400	9.5	無																																		

赤字：設備、運用又は体制の相違（設計方針の相違）
 青字：記載箇所又は記載内容の相違（記載方針の相違）
 緑字：記載表現、設備名称の相違（実質的な相違なし）

第6条 外部からの衝撃による損傷の防止（竜巻：別添資料1 添付資料3.11）

大飯発電所3/4号炉	女川原子力発電所2号炉	泊発電所3号炉	相違理由
<div data-bbox="85 236 685 647" style="border: 1px solid black; height: 258px; width: 268px; margin-bottom: 10px;"></div> <div data-bbox="174 655 577 679" style="font-size: small;">第4-2図 応力-ひずみ線図（鋼板、SS400、厚さ9mm）</div> <div data-bbox="85 737 622 1088" style="border: 1px solid black; height: 220px; width: 240px; margin-bottom: 10px;"></div> <div data-bbox="163 1098 533 1121" style="font-size: small;">第4-3図 応力-ひずみ線図（重錘、SS400、厚さ16mm）</div> <div data-bbox="248 1262 685 1286" style="border: 1px solid black; font-size: x-small; padding: 2px;"> 枠囲みの範囲は機密に係る事項ですので公開することはできません。 </div>			

赤字：設備、運用又は体制の相違（設計方針の相違）
 青字：記載箇所又は記載内容の相違（記載方針の相違）
 緑字：記載表現、設備名称の相違（実質的な相違なし）

第6条 外部からの衝撃による損傷の防止（竜巻：別添資料1 添付資料3.11）

大飯発電所3/4号炉	女川原子力発電所2号炉	泊発電所3号炉	相違理由
<div data-bbox="91 236 680 628" style="border: 2px solid black; height: 246px; width: 263px; margin-bottom: 10px;"></div> <div data-bbox="183 627 589 651" style="font-size: small;">第4-4図 ケースSS-1におけるミーゼス応力の最大値の時刻歴</div> <div data-bbox="91 711 680 1091" style="border: 2px solid black; height: 238px; width: 263px; margin-bottom: 10px;"></div> <div data-bbox="183 1093 584 1118" style="font-size: small;">第4-5図 ケースSS-2におけるミーゼス応力の最大値の時刻歴</div> <div data-bbox="250 1171 680 1198" style="border: 1px solid black; padding: 2px; font-size: x-small; margin-top: 10px;"> 押附みの範囲は機密に係る事項ですので公開することはできません。 </div>			

赤字：設備、運用又は体制の相違（設計方針の相違）
 青字：記載箇所又は記載内容の相違（記載方針の相違）
 緑字：記載表現、設備名称の相違（実質的な相違なし）

第6条 外部からの衝撃による損傷の防止（竜巻：別添資料1 添付資料3.11）

大飯発電所3/4号炉	女川原子力発電所2号炉	泊発電所3号炉	相違理由
<div data-bbox="85 236 685 628" style="border: 2px solid black; height: 246px; width: 268px; margin-bottom: 10px;"></div> <div data-bbox="174 628 577 651" style="font-size: small;">第4-6図 ケースSS-3におけるミーゼス応力の最大値の時刻歴</div> <div data-bbox="85 708 685 1094" style="border: 2px solid black; height: 242px; width: 268px; margin-bottom: 10px;"></div> <div data-bbox="174 1094 577 1117" style="font-size: small;">第4-7図 ケースSS-4におけるミーゼス応力の最大値の時刻歴</div> <div data-bbox="250 1174 685 1197" style="border: 1px solid black; padding: 2px; font-size: x-small; margin-top: 10px;"> 枠囲みの範囲は機密に係る事項ですので公開することはできません。 </div>			

赤字：設備、運用又は体制の相違（設計方針の相違）
 青字：記載箇所又は記載内容の相違（記載方針の相違）
 緑字：記載表現、設備名称の相違（実質的な相違なし）

第6条 外部からの衝撃による損傷の防止（竜巻：別添資料1 添付資料3.11）

大飯発電所3/4号炉	女川原子力発電所2号炉	泊発電所3号炉	相違理由
<div data-bbox="85 236 676 571" style="border: 2px solid black; width: 100%; height: 100%;"></div> <p data-bbox="174 577 586 598">第4-8図 ケースSS-4における解析終了時のミーゼス応力分布図</p> <div data-bbox="250 1056 685 1082" style="border: 1px solid black; padding: 2px; margin-top: 100px;"> <p data-bbox="295 1059 640 1075">持問みの範囲は機密に係る事項ですので公開することはできません。</p> </div>			

赤字：設備、運用又は体制の相違（設計方針の相違）
 青字：記載箇所又は記載内容の相違（記載方針の相違）
 緑字：記載表現、設備名称の相違（実質的な相違なし）

第6条 外部からの衝撃による損傷の防止（竜巻：別添資料1 添付資料3.11）

大飯発電所3/4号炉	女川原子力発電所2号炉	泊発電所3号炉	相違理由
<p style="text-align: center;">別紙2 付録3</p> <p>電力中央研究所報告「竜巻飛来物を模擬した重錘の鋼板上への自由落下衝突試験による鋼板貫通評価手法の提案」における柔パイプ重錘の自由落下衝突試験結果の成果の適用条件について</p> <p>1. 概要</p> <p>別紙2 付録3 においては、DG水密扉への設計飛来物貫通評価（BRL 式における貫通評価）に対する電中研成果（柔パイプ重錘における自由落下衝突試験結果の知見）の適用性及び保守性について記載しているが、本資料においては、その他の評価対象施設（竜巻防護施設、竜巻防護施設を内包する施設及び竜巻飛来物防護対策設備）への貫通評価に対しての電中研成果（柔パイプ重錘における自由落下衝突試験結果の知見）の適用条件に関する考え方を参考に記載にする。</p> <p>電中研成果（柔パイプ重錘における自由落下衝突試験結果の知見）の適用条件に関する考え方の検討フローを以下の第1-1 図に示す。</p> <div data-bbox="73 730 692 1114" style="border: 1px solid black; padding: 5px;"> <p style="text-align: center;">第1-1図 電中研成果（柔パイプ重錘における試験結果の知見）の適用条件に関する考え方の検討フロー</p> </div> <p>2. 電中研成果のうち柔パイプ重錘における自由落下衝突試験の知見の適用条件</p> <p>(1) 柔パイプ重錘における自由落下衝突試験の試験条件について</p> <p>第2-1 表に柔パイプ重錘における自由落下衝突試験における飛来物と被衝突体の条件を示す。第2-1 表に記載のとおり、<u>被衝突体は形状が平板であり、材質 SS400、有効開口部のサイズが縦 1400mm×横 1400mm×厚み 9mm、接続条件は 2 辺固定であることから、本条件と同等以上の場合に柔パイプ重錘における試験結果の知見（知見③）を適用することとする。</u></p> <p>(2) 柔パイプ重錘における自由落下衝突試験の試験条件に係る同等</p>			

赤字：設備、運用又は体制の相違（設計方針の相違）
 青字：記載箇所又は記載内容の相違（記載方針の相違）
 緑字：記載表現、設備名称の相違（実質的な相違なし）

第6条 外部からの衝撃による損傷の防止（竜巻：別添資料1 添付資料3.11）

大飯発電所3/4号炉	女川原子力発電所2号炉	泊発電所3号炉	相違理由																								
<p>以上について</p> <p>第2-1表に記載の試験条件のうち、被衝突体の材質、有効開口部のサイズ及び接続部の固定条件における同等以上について明確化を行うため、「材質については、SS400及びSUS304」、「有効開口部のサイズについては、縦1400mm×横1400mm×厚み9mm、縦1000mm×横1000mm×厚み9mm及び縦800mm×横800mm×厚み9mm」、「接続部の固定条件については2辺固定及び4辺固定」とした場合の適用条件について、電中研にて3次元FEMモデルによる飛来物衝突解析を実施した結果を第2-2表に示す。</p> <div style="border: 1px solid black; height: 40px; width: 100%;"></div> <p>(3) 柔パイプ重錘における自由落下衝突試験の知見の適用条件について</p> <div style="border: 1px solid black; height: 150px; width: 100%;"></div> <p>第2-1表 柔パイプ重錘における自由落下衝突試験の試験条件</p> <table border="1" data-bbox="82 927 667 1046"> <thead> <tr> <th colspan="4">飛来物</th> <th colspan="4">被衝突体</th> </tr> <tr> <th>名称</th> <th>形状(材質)</th> <th>衝突断面形状(mm)</th> <th>衝突エネルギー(kJ)</th> <th>形状</th> <th>材質</th> <th>有効開口部のサイズ(mm)</th> <th>接続部</th> </tr> </thead> <tbody> <tr> <td>柔パイプ重錘</td> <td>角パイプ(SS400)</td> <td>250×250×t4.5</td> <td>182</td> <td>平板</td> <td>SS400</td> <td>縦1400×横1400×厚み9</td> <td>2辺固定</td> </tr> </tbody> </table> <div style="border: 1px solid black; padding: 5px; width: fit-content; margin: 10px auto;"> <p>特開みの範囲は機密に係る事項ですので公開することはできません。</p> </div>	飛来物				被衝突体				名称	形状(材質)	衝突断面形状(mm)	衝突エネルギー(kJ)	形状	材質	有効開口部のサイズ(mm)	接続部	柔パイプ重錘	角パイプ(SS400)	250×250×t4.5	182	平板	SS400	縦1400×横1400×厚み9	2辺固定			
飛来物				被衝突体																							
名称	形状(材質)	衝突断面形状(mm)	衝突エネルギー(kJ)	形状	材質	有効開口部のサイズ(mm)	接続部																				
柔パイプ重錘	角パイプ(SS400)	250×250×t4.5	182	平板	SS400	縦1400×横1400×厚み9	2辺固定																				

赤字：設備、運用又は体制の相違（設計方針の相違）
 青字：記載箇所又は記載内容の相違（記載方針の相違）
 緑字：記載表現、設備名称の相違（実質的な相違なし）

第6条 外部からの衝撃による損傷の防止（竜巻：別添資料1 添付資料3.11）

大飯発電所3/4号炉	女川原子力発電所2号炉	泊発電所3号炉	相違理由																		
<p>第2-2表 電中研解析手法を用いた被衝突体の材質、有効開口部のサイズ及び固定条件における同等以上の検討結果について</p> <table border="1" data-bbox="85 288 676 660"> <thead> <tr> <th colspan="3">設計機来物の条件</th> <th colspan="2">被衝突体</th> <th rowspan="2">貫通有無(○：無、×：有)</th> </tr> <tr> <th>材質</th> <th>寸法(mm)</th> <th>衝突速度(m/s)</th> <th>材質</th> <th>有効開口部サイズ(mm)</th> </tr> </thead> <tbody> <tr> <td rowspan="2">SN490B^{※1}</td> <td rowspan="2">縦200×横300×長さ4200(板厚4.22)</td> <td rowspan="2">51</td> <td>SS400</td> <td rowspan="2">[Redacted]</td> <td rowspan="2"></td> </tr> <tr> <td>SUS304</td> </tr> </tbody> </table> <p>※1：自由落下衝突試験における柔バイズ重錘の材質はSS400であるが、解析においては、保守的にSN490Bとした。</p> <p>第2-3表 電中研の知見（知見⑤：設計機来物の衝突面の投影面積と等価な円の直径をDBLとして計算可能な範囲とする）の適用条件</p> <div data-bbox="85 791 676 948" style="border: 2px solid black; height: 100px; width: 100%;"></div> <div data-bbox="280 1121 687 1150" style="border: 1px solid black; padding: 2px; text-align: center;"> 特開の範囲は機密に係る事項ですので公開することはできません。 </div>	設計機来物の条件			被衝突体		貫通有無(○：無、×：有)	材質	寸法(mm)	衝突速度(m/s)	材質	有効開口部サイズ(mm)	SN490B ^{※1}	縦200×横300×長さ4200(板厚4.22)	51	SS400	[Redacted]		SUS304			
設計機来物の条件			被衝突体		貫通有無(○：無、×：有)																
材質	寸法(mm)	衝突速度(m/s)	材質	有効開口部サイズ(mm)																	
SN490B ^{※1}	縦200×横300×長さ4200(板厚4.22)	51	SS400	[Redacted]																	
			SUS304																		

赤字：設備、運用又は体制の相違（設計方針の相違）
 青字：記載箇所又は記載内容の相違（記載方針の相違）
 緑字：記載表現、設備名称の相違（実質的な相違なし）

第6条 外部からの衝撃による損傷の防止（竜巻：別添資料1 添付資料3.12）

大飯発電所3/4号炉	女川原子力発電所2号炉	泊発電所3号炉	相違理由
<p style="text-align: right;">別紙17</p> <p>起回事象を竜巻とした場合の排気筒の取り扱いについて</p> <p>排気筒（厚さ3mm）については、最大風速100m/sの竜巻において飛来物により損傷するとの評価結果となっていることから、その対応について、大飯3号機を基に以下のとおり整理した。</p> <p>1. 排気筒の安全機能</p> <ul style="list-style-type: none"> ・「設置許可基準規則」において、「安全機能」は次のように定義されている。 <div style="border: 1px solid black; padding: 5px;"> <p>五 「安全機能」とは、発電用原子炉施設の安全性を確保するために必要な機能であって、次に掲げるものをいう。</p> <p>イ その機能の喪失により発電用原子炉施設に運転時の異常な過渡変化又は設計基準事故が発生し、これにより公衆又は従事者に放射線障害を及ぼすおそれがある機能</p> <p>ロ 発電用原子炉施設の運転時の異常な過渡変化又は設計基準事故の拡大を防止し、又は速やかにその事故を収束させることにより、公衆又は従事者に及ぼすおそれがある放射線障害を防止し、及び放射性物質が発電用原子炉を設置する工場又は事業所外へ放出されることを抑制し、又は防止する機能</p> </div> <p>・排気筒については、設計基準事故である原子炉冷却材喪失、制御棒飛び出しにおいて、格納容器等から放出される放射性物質による敷地等境界での被ばくを軽減するため、排気筒を経由した高所クレジットを期待し安全解析を実施している。</p> <p>このことから、排気筒の有する安全機能、つまり放射性物質の放出低減機能は「発電用原子炉施設の運転時の異常な過渡変化又は設計基準事故の拡大を防止し、又は速やかにその事故を収束させることにより、公衆又は従事者に及ぼすおそれがある放射線障害を防止し、及び放射性物質が発電用原子炉を設置する工場又は事業所外へ放出されることを抑制し、又は防止する機能」に該当することになる。</p>		<p style="text-align: right;">添付資料3.12</p> <p>起回事象を竜巻とした場合の排気筒の取り扱いについて</p> <p>排気筒（厚さ4mm）については、最大風速100m/sの竜巻において飛来物により損傷するとの評価結果となっていることから、その対応について、以下のとおり整理した。</p> <p>1. 排気筒の安全機能</p> <ul style="list-style-type: none"> ・「設置許可基準規則」において、「安全機能」は次のように定義されている。 <div style="border: 1px solid black; padding: 5px;"> <p>五 「安全機能」とは、発電用原子炉施設の安全性を確保するために必要な機能であって、次に掲げるものをいう。</p> <p>イ その機能の喪失により発電用原子炉施設に運転時の異常な過渡変化又は設計基準事故が発生し、これにより公衆又は従事者に放射線障害を及ぼすおそれがある機能</p> <p>ロ 発電用原子炉施設の運転時の異常な過渡変化又は設計基準事故の拡大を防止し、又は速やかにその事故を収束させることにより、公衆又は従事者に及ぼすおそれがある放射線障害を防止し、及び放射性物質が発電用原子炉を設置する工場又は事業所（以下「工場等」という。）外へ放出されることを抑制し、又は防止する機能</p> </div> <p>・排気筒については、設計基準事故である原子炉冷却材喪失、制御棒飛び出しにおいて、格納容器等から放出される放射性物質による敷地境界での被ばくを軽減するため、排気筒を経由した高所クレジットを期待し安全解析を実施している。</p> <p>このことから、排気筒の有する安全機能、つまり放射性物質の放出低減機能は「発電用原子炉施設の運転時の異常な過渡変化又は設計基準事故の拡大を防止し、又は速やかにその事故を収束させることにより、公衆又は従事者に及ぼすおそれがある放射線障害を防止し、及び放射性物質が発電用原子炉を設置する工場又は事業所外へ放出されることを抑制し、又は防止する機能」に該当することになる。</p>	<p>【大飯】 記載表現の相違 【女川】 記載の充実 ・大飯審査実績の反映</p> <p>【大飯】 設計の相違</p> <p>【大飯】 法令の改正による相違 （以下、法令の引用に関する相違は、相違理由の記載を省略する。）</p> <p>【大飯】 評価範囲の相違 ・大飯の評価範囲には、地役権設定区域を含んでいるため、“等”を記載している。一方で、泊の評価範囲に地役権設定区域はない状況で申請中のため、“等”の記載は必要ない。（以下、同様の相違理由は省略する。）</p>

赤字：設備、運用又は体制の相違（設計方針の相違）
 青字：記載箇所又は記載内容の相違（記載方針の相違）
 緑字：記載表現、設備名称の相違（実質的な相違なし）

第6条 外部からの衝撃による損傷の防止（竜巻：別添資料1 添付資料3.12）

大飯発電所3/4号炉	女川原子力発電所2号炉	泊発電所3号炉	相違理由
<p>なお、設計基準事故のうち周辺環境に影響を与える事故として、原子炉冷却材喪失以外にも、放射性気体廃棄物処理施設の破損、蒸気発生器伝熱管破損並びに燃料集合体の落下が該当するが、これら事象については排気筒からの高所クレジットを期待しない地上放出にて安全解析を実施している。</p> <ul style="list-style-type: none"> ・平常時にも排気筒からは、格納容器内の空気のパーティ、気体廃棄物の計画放出等を実施している。その際も排気筒からの高所放出を期待して敷地等境界での被ばく評価を実施しているが、これはALARAの精神に対応するものであり、設置許可基準規則の安全機能に該当するものではない。 <p>2. 設置許可基準第6条（外部からの衝撃による損傷の防止）及び27条（放射性廃棄物の処理施設）への適合性</p> <ul style="list-style-type: none"> ・設置許可基準規則第6条の要求は次のようになっている。 <div style="border: 1px solid black; padding: 5px;"> <p>安全施設は、想定される自然現象（地震及び津波を除く。次項において同じ。）が発生した場合においても安全機能を損なわないものでなければならない。</p> <p>2 重要安全施設は、当該需要安全施設に大きな影響を及ぼすおそれがあると想定される自然事象により当該重要安全施設に作用する衝撃及び設計基準事故時に生ずる応力を適切に考慮したものでなければならない。</p> <p>（解釈）</p> <p>3 第1項に規定する「想定される自然現象（地震及び津波を除く。）が発生した場合においても安全機能を損なわないもの」とは、設計上の考慮を要する自然現象又はその組み合わせに遭遇した場合において、自然事象そのものがもたらす環境条件及びその結果として施設で生じ得る環境条件において、その設備が有する安全機能が達成されることをいう。</p> <p>5 第2項に規定する「大きな影響を及ぼすおそれがあると想定される自然事象」とは、対象となる自然事象に対応して、最新の科学的技術的知見を踏まえて適切に予想されるものをいう。なお、過去の記録、現地調査の結果及び最新知見等を参考にして、必要のある場合には、異種の自然事象を重畳させるものとする。</p> <p>6 第2項に規定する「適切に考慮したもの」とは、大きな影響を及ぼすおそれがあると想定される自然事象により当該重要安全施設に作用する衝撃及び設計基準事故が発生した場合に生じる応力を単純に加算することを必ずしも要求するものではなく、それぞれの因果関係及び時間的変化を考慮して適切に組み合わせた場合をいう。</p> </div>	<p>女川原子力発電所2号炉</p>	<p>なお、設計基準事故のうち周辺環境に影響を与える事故として、原子炉冷却材喪失以外にも、放射性気体廃棄物処理施設の破損、蒸気発生器伝熱管破損並びに燃料集合体の落下が該当するが、これら事象については排気筒からの高所クレジットを期待しない地上放出にて安全解析を実施している。</p> <ul style="list-style-type: none"> ・平常時にも排気筒からは、格納容器内の空気のパーティ、気体廃棄物の計画放出等を実施している。その際も排気筒からの高所放出を期待して敷地境界での被ばく評価を実施しているが、これはALARAの精神に対応するものであり、設置許可基準規則の安全機能に該当するものではない。 <p>2. 設置許可基準第6条（外部からの衝撃による損傷の防止）及び27条（放射性廃棄物の処理施設）への適合性</p> <ul style="list-style-type: none"> ・設置許可基準規則第6条の要求は次のようになっている。 <div style="border: 1px solid black; padding: 5px;"> <p>安全施設（兼用キャスクを除く。）は、想定される自然現象（地震及び津波を除く。次項において同じ。）が発生した場合においても安全機能を損なわないものでなければならない。</p> <p>2 重要安全施設は、当該需要安全施設に大きな影響を及ぼすおそれがあると想定される自然現象により当該重要安全施設に作用する衝撃及び設計基準事故時に生ずる応力を適切に考慮したものでなければならない。</p> <p>（解釈）</p> <p>3 第1項に規定する「想定される自然現象（地震及び津波を除く。）が発生した場合においても安全機能を損なわないもの」とは、設計上の考慮を要する自然現象又はその組み合わせに遭遇した場合において、自然事象そのものがもたらす環境条件及びその結果として施設で生じ得る環境条件において、その設備が有する安全機能が達成されることをいう。</p> <p>5 第2項に規定する「大きな影響を及ぼすおそれがあると想定される自然現象」とは、対象となる自然現象に対応して、最新の科学的技術的知見を踏まえて適切に予想されるものをいう。なお、過去の記録、現地調査の結果及び最新知見等を参考にして、必要のある場合には、異種の自然現象を重畳させるものとする。</p> <p>6 第2項に規定する「適切に考慮したもの」とは、大きな影響を及ぼすおそれがあると想定される自然現象により当該重要安全施設に作用する衝撃及び設計基準事故が発生した場合に生じる応力を単純に加算することを必ずしも要求するものではなく、それぞれの因果関係及び時間的変化を考慮して適切に組み合わせた場合をいう。</p> </div>	<p>相違理由</p>

赤字：設備、運用又は体制の相違（設計方針の相違）
 青字：記載箇所又は記載内容の相違（記載方針の相違）
 緑字：記載表現、設備名称の相違（実質的な相違なし）

第6条 外部からの衝撃による損傷の防止（竜巻：別添資料1 添付資料3.12）

大飯発電所3/4号炉	女川原子力発電所2号炉	泊発電所3号炉	相違理由
<p>・竜巻を起因として、原子炉冷却材喪失、制御棒飛び出しに発展することがないよう、1次冷却材配管、制御棒駆動装置等は、原子炉格納容器、原子炉建屋等の頑健な建屋内に施設していること、原子炉補機冷却水用の海水ポンプについては防護ネットにて防護していることから、竜巻を起因としてこれら設計基準事故に発展することはない。</p> <p>上記の1項で述べたように、排気筒が有する安全機能は原子炉冷却材喪失、制御棒飛び出しにおける放射性物質の放出低減機能であり、竜巻を起因としてこれらの設計基準事故に発展することはないことから、竜巻影響評価においては、設計基準事故と重ならない限りにおいて排気筒に求められる安全機能要求はない。</p> <p>また、設計基準事故と最大風速100m/s（ハザード曲線から10⁻¹/炉・年程度）の竜巻の発生頻度、飛来物が排気筒に衝突する頻度を考えた場合、設計基準事故との重ね合わせは、その可能性が小さいものと考えている。従って、竜巻影響評価においては、3項で述べる点検、補修、原子炉停止等の対応をとることにより、第6条に求めている自然事象そのものがもたらす環境条件の結果として生じ得る環境条件において、安全機能の要求はなく第6条に適合しているものと考えている。</p> <p>なお、風速約30～49m/s（ハザード曲線から10⁻³～10⁻⁴/炉・年以下）では、飛来物として想定している鋼製材、鉄パイプ、砂利において、砂利のみが49m/sにて3m舞い上がるが、砂利の貫通厚さは1mm程度であるので厚さ3mmの排気筒を貫通することはない。</p> <p>さらに、原子炉冷却材喪失時において排気筒に期待している高所放出の安全機能について、事故の中で被ばく上最も厳しい原子炉冷却材喪失において、排気筒機能を喪失したと仮定した場合の影響評価をした結果、添付十の結果が約0.051mSv（高所放出）から約0.078mSv（地上放出）に増加するものの、線量めやす値である5mSvを超えないことを確認している。</p> <p>また、排気筒の機能喪失を仮定した場合の、中央制御室等における運転員の実効線量は3号炉で約26mSv及び4号炉で約14mSvであり、判断のめやすの実効線量100mSvを超えないことを確認している。</p>		<p>・竜巻を起因として、原子炉冷却材喪失、制御棒飛び出しに発展することがないよう、1次冷却材配管、制御棒駆動装置等は、原子炉格納容器、原子炉建屋等の頑健な建屋内に施設していること、原子炉補機冷却水海水ポンプについては竜巻防護ネットにて防護していることから、竜巻を起因としてこれら設計基準事故に発展することはない。</p> <p>上記の1項で述べたように、排気筒が有する安全機能は原子炉冷却材喪失、制御棒飛び出しにおける放射性物質の放出低減機能であり、竜巻を起因としてこれらの設計基準事故に発展することはないことから、竜巻影響評価においては、設計基準事故と重ならない限りにおいて排気筒に求められる安全機能要求はない。</p> <p>また、設計基準事故と最大風速100m/s（ハザード曲線から10⁻¹/炉・年程度）の竜巻の発生頻度、飛来物が排気筒に衝突する頻度を考えた場合、設計基準事故との重ね合わせは、その可能性が小さいものと考えている。従って、竜巻影響評価においては、3項で述べる点検、補修、原子炉停止等の対応をとることにより、第6条に求めている自然事象そのものがもたらす環境条件の結果として生じ得る環境条件において、安全機能の要求はなく第6条に適合しているものと考えている。</p> <p>なお、風速約33～53m/s（ハザード曲線から10⁻³～10⁻⁴/炉・年以下）では、飛来物として想定している鋼製材、鉄パイプ、砂利において、砂利のみが53m/sにて9m舞い上がるが、砂利の貫通厚さは1mm程度であるので厚さ4mmの排気筒を貫通することはない。</p> <p>さらに、原子炉冷却材喪失時において排気筒に期待している高所放出の安全機能について、事故の中で被ばく上最も厳しい原子炉冷却材喪失において、排気筒機能を喪失したと仮定した場合の影響評価をした結果、添付十の結果が約0.23mSv（高所放出）であるのに対し、地上放出の場合も約0.23mSvと同等であることから、線量めやす値である5mSvを超えないことを確認している。</p> <p>また、排気筒の機能喪失を仮定した場合の、中央制御室等における運転員の実効線量は3号炉で約28mSvであり、判断のめやすの実効線量100mSvを超えないことを確認している。</p>	<p>相違理由</p> <p>【大飯】 記載表現の相違</p> <p>【大飯】 設備名称の相違</p> <p>【大飯】 ハザード曲線の違いによる評価結果の相違</p> <p>【大飯】 解析条件の相違</p> <p>【大飯】 解析条件の違いによる評価結果の相違</p> <p>【大飯】 記載方針の相違</p>

赤字：設備、運用又は体制の相違（設計方針の相違）
 青字：記載箇所又は記載内容の相違（記載方針の相違）
 緑字：記載表現、設備名称の相違（実質的な相違なし）

第6条 外部からの衝撃による損傷の防止（竜巻：別添資料1 添付資料3.12）

大阪発電所3/4号炉	女川原子力発電所2号炉	泊発電所3号炉	相違理由
<p>・設置許可基準規則第27条の要求は次のようになっている。</p> <p>工場等には、次に掲げるところにより、通常運転時において放射性廃棄物（実用炉規則第二条第二項第二号に規定する放射性廃棄物をいう。以下同じ。）を処理する施設（安全施設に係るものに限る。以下この条において同じ。）を設けなければならない。</p> <p>一 周辺監視区域の外の空气中及び周辺監視区域の境界における水中の放射性物質の濃度を十分に低減できるよう、発電用原子炉施設において発生する放射性廃棄物を処理する能力を有するものとする。</p> <p>（解釈）</p> <p>1 第1号に規定する「放射性物質の濃度を十分に低減できる」とは、気体廃棄物処理施設にあつては、ろ過、貯留、減衰及び管理等により、液体廃棄物処理施設にあつてはろ過、蒸発処理、イオン交換、貯留、減衰及び管理等によること。</p> <p>2 第1号に規定する「十分に低減できる」とは、As Low As Reasonably Achievable(ALARA)の考え方の下、当該工場等として「発電用軽水型原子炉施設周辺の線量目標値に関する指針」（昭和50年5月13日原子力安全委員会決定）において定める線量目標値（50マイクロシーベルト/年）が達成できるものであること。</p> <p>3 上記2の線量目標値の評価に当たっては、「発電用軽水型原子炉施設周辺の線量目標値に対する評価指針」（昭和51年9月28日原子力安全委員会決定）等において定めるところによること。</p> <p>・平常時の被ばく評価において、排気筒機能を喪失したと仮定（1年間）した場合の影響確認をした結果、添付九評価の結果約9μSvから約15μSvに増加するものの、線量めやす値である50μSvを超えないことを確認していることから、第27条に適合しているものと考えている。</p> <p>3. 排気筒が破損した場合の運用面での対応</p> <p>・発電所に竜巻襲来の恐れがある場合には、格納容器内の空気のパージ、気体廃棄物の計画放出等の操作を実施している場合には直ちに停止する。さらに、竜巻の襲来を確認した場合には、竜巻通過後速やかに排気筒の点検を実施する。</p> <p>具体的な点検は、次の手順で実施する。</p> <p>①双眼鏡を用いて排気筒全体に塗膜の剥離状況（上塗りと下塗りでは塗装色が異なる）、凹みの確認、異音の有無を確認する。</p> <p>②①で確認した結果、異常を確認した部位を恒設点検歩廊、格納容器屋上部歩廊、隣接号機の恒設点検歩廊等を用い重点的に双眼鏡による点検、異音の有無を確認する。恒設点検歩廊等から確認できにくい部分は仮設足場などを利用し点検する。</p>		<p>・設置許可基準規則第27条の要求は次のようになっている。</p> <p>工場等には、次に掲げるところにより、通常運転時において放射性廃棄物（実用炉規則第二条第二項第二号に規定する放射性廃棄物をいう。以下同じ。）を処理する施設（安全施設に係るものに限る。以下この条において同じ。）を設けなければならない。</p> <p>一 周辺監視区域の外の空气中及び周辺監視区域の境界における水中の放射性物質の濃度を十分に低減できるよう、発電用原子炉施設において発生する放射性廃棄物を処理する能力を有するものとする。</p> <p>（解釈）</p> <p>1 第1号に規定する「放射性物質の濃度を十分に低減できる」とは、気体廃棄物処理施設にあつては、ろ過、貯留、減衰及び管理等により、液体廃棄物処理施設にあつてはろ過、蒸発処理、イオン交換、貯留、減衰及び管理等によること。</p> <p>2 第1号に規定する「十分に低減できる」とは、As Low As Reasonably Achievable(ALARA)の考え方の下、当該工場等として「発電用軽水型原子炉施設周辺の線量目標値に関する指針」（昭和50年5月13日原子力安全委員会決定）において定める線量目標値（50マイクロシーベルト/年）が達成できるものであること。</p> <p>3 上記2の線量目標値の評価に当たっては、「発電用軽水型原子炉施設周辺の線量目標値に対する評価指針」（昭和51年9月28日原子力安全委員会決定）等において定めるところによること。</p> <p>・平常時の被ばく評価において、排気筒機能を喪失したと仮定（1年間）した場合の影響確認をした結果、添付九評価の結果約7.9μSvから約8.1μSvに増加するものの、線量めやす値である50μSvを超えないことを確認していることから、第27条に適合しているものと考えている。</p> <p>3. 排気筒が破損した場合の運用面での対応</p> <p>・発電所に竜巻襲来の恐れがある場合には、格納容器内の空気のパージ、気体廃棄物の計画放出等の操作を実施している場合には直ちに停止する。さらに、竜巻の襲来を確認した場合には、竜巻通過後速やかに排気筒の点検を実施する。</p> <p>具体的な点検は、次の手順で実施する。</p> <p>①双眼鏡を用いて排気筒全体に塗膜の剥離状況（上塗りと下塗りでは塗装色が異なる）、凹みの確認、異音の有無を確認する。</p> <p>②①で確認した結果、異常を確認した部位を恒設点検歩廊、格納容器屋上部歩廊を用い重点的に双眼鏡による点検、異音の有無を確認する。恒設点検歩廊等から確認できにくい部分は仮設足場などを利用し点検する。</p>	<p>【大阪】 解析条件の違いによる評価結果の相違</p> <p>【大阪】 確認時に使用する歩廊の相違</p>

赤字：設備、運用又は体制の相違（設計方針の相違）
 青字：記載箇所又は記載内容の相違（記載方針の相違）
 緑字：記載表現、設備名称の相違（実質的な相違なし）

第6条 外部からの衝撃による損傷の防止（竜巻：別添資料1 添付資料3.12）

大飯発電所3/4号炉	女川原子力発電所2号炉	泊発電所3号炉	相違理由
<p>なお、双眼鏡による目視確認では直径10mm程度の貫通穴であれば確認は可能であると考えている。（別紙参照）</p> <ul style="list-style-type: none"> 目視確認により排気筒に破損が確認された場合には、排気筒内を流れる流体の圧力は5kPa以下であることから、貫通穴を確認した場合は、金属パテとステンレステーブあるいはステンレス板と金属接着剤による応急補修を実施する。 貫通穴を確認し応急補修できない場合には、高所放出が期待できないものと判断し、保安規定・運転操作手順に従いプラントを停止させ原子炉冷却材喪失等発生時の蓋然性が低いプラント運転状態（モード5まで移行）に移行させる。（定格出力からRCS温度93℃への移行時間約23時間） <p>なお、この間にプラント停止に伴う格納容器からのページ等の平常時による影響を考慮した場合、敷地等境界での被ばくは約2.1μSvである。</p> <ul style="list-style-type: none"> 更に、竜巻襲来後の点検において損傷が確認されなかった場合にも、至近の定検において仮設足場等を設置して排気筒の細部点検を実施する。 <p>以上、竜巻を起因として放射性物質の放出を伴う設計基準事故に発展することはないことから、設計基準事故と重ならない限りにおいて竜巻影響評価においては、排気筒に求められる安全機能要求はなく、また、点検、補修、原子炉停止等の対応をとることにより、設置許可基準第6条及び第27条にも適合しているものと考えている。</p> <p>このため、万一排気筒が破損した場合は、原子炉冷却材喪失等が生じないプラント運転状態に短時間に移行することが可能であることから、容易に応急補修できない損傷を確認した場合は保安規定・運転操作手順に従いプラントを停止し、原子炉冷却材喪失等発生時の蓋然性が低いプラント運転状態（モード5）に短時間に移行することで対応する。</p> <p>なお、今後、竜巻発生後の排気筒の点検方法、点検結果を踏まえたプラント対応等の詳細を検討する。</p> <p style="text-align: right;">以上</p> <p>別紙：排気筒の健全性確認方法 参考：地上放出時の実行線量評価</p>	<p>女川原子力発電所2号炉</p>	<p>なお、双眼鏡による目視確認では直径10mm程度の貫通穴であれば確認は可能であると考えている。（別紙参照）</p> <ul style="list-style-type: none"> 目視確認により排気筒に破損が確認された場合には、排気筒内を流れる流体の圧力は5kPa以下であることから、貫通穴を確認した場合は、当て板とステンレステーブあるいは紫外線硬化型FRPシートとシール材による応急補修を実施する。 貫通穴を確認し応急補修できない場合には、高所放出が期待できないものと判断し、保安規定・運転操作手順に従いプラントを停止させ原子炉冷却材喪失等発生時の蓋然性が低いプラント運転状態（モード5まで移行）に移行させる。（定格出力からRCS温度93℃への移行時間約27時間） <p>なお、この間にプラント停止に伴う格納容器からのページ等の平常時による影響を考慮した場合、敷地境界での被ばくは約0.074μSvである。</p> <ul style="list-style-type: none"> さらに、竜巻襲来後の点検において損傷が確認されなかった場合にも、至近の定検において仮設足場等を設置して排気筒の細部点検を実施する。 <p>以上、竜巻を起因として放射性物質の放出を伴う設計基準事故に発展することはないことから、設計基準事故と重ならない限りにおいて竜巻影響評価においては、排気筒に求められる安全機能要求はなく、また、点検、補修、原子炉停止等の対応をとることにより、設置許可基準第6条及び第27条にも適合しているものと考えている。</p> <p>このため、万一排気筒が破損した場合は、原子炉冷却材喪失等が生じないプラント運転状態に短時間に移行することが可能であることから、容易に応急補修できない損傷を確認した場合は保安規定・運転操作手順に従いプラントを停止し、原子炉冷却材喪失等発生時の蓋然性が低いプラント運転状態（モード5）に短時間に移行することで対応する。</p> <p>なお、今後、竜巻発生後の排気筒の点検方法、点検結果を踏まえたプラント対応等の詳細を検討する。</p> <p style="text-align: right;">以上</p> <p>別紙：排気筒の健全性確認方法 参考：地上放出時の実効線量評価</p>	<p>相違理由</p> <p>【大飯】 補修に使用する材料の相違</p> <p>【大飯】 運転実績の相違</p> <p>【大飯】 解析条件の違いによる評価結果の相違</p> <p>【大飯】 記載表現の相違</p> <p>【大飯】 記載表現の相違</p>

赤字：設備、運用又は体制の相違（設計方針の相違）
 青字：記載箇所又は記載内容の相違（記載方針の相違）
 緑字：記載表現、設備名称の相違（実質的な相違なし）

大飯発電所3/4号炉	女川原子力発電所2号炉	泊発電所3号炉	相違理由
<p>別紙：排気筒の健全性確認方法</p> <p>下図のように排気筒への寄り付きは恒設点検歩廊で可能であり、また、双眼鏡での目視点検も可能である。</p> 		<p>別紙：排気筒の健全性確認方法</p> <p>下図のように排気筒への寄り付きは恒設点検歩廊で可能であり、また、双眼鏡での目視点検も可能である。</p> 	<p>【大飯】 記載表現の相違 写真の視野は、異なるが、手順は同様である。</p>

赤字：設備、運用又は体制の相違（設計方針の相違）
 青字：記載箇所又は記載内容の相違（記載方針の相違）
 緑字：記載表現、設備名称の相違（実質的な相違なし）

第6条 外部からの衝撃による損傷の防止（竜巻：別添資料1 添付資料3.12）

大飯発電所3/4号炉	女川原子力発電所2号炉	泊発電所3号炉	相違理由
<p>【参考：地上放出時の実行線量評価】</p> <p>竜巻による排気筒損傷と原子炉冷却材喪失事故が重畳したと仮定した場合、本来排気筒から高所放出される気体状の放射性物質を含む内部流体は、フィルタユニット通過後、低所から放出されることになる。このため、公衆又は従業者の被ばくの増加が考えられる。</p> <p>上記のような考え方を元に、公衆への影響評価として、原子炉冷却材喪失時（設計基準事故）を想定し、排気筒により高所放出されず、保守的に全量が地上放出されるとした場合の敷地等境界外における実効線量の評価を実施した。</p> <p>また、従事者への影響評価としては、第42回原子力発電所の新規制基準適合性に係る審査会合「資料1-1 大飯原子力発電所3号炉及び4号炉中央制御室について」（平成25年11月5日）において排気筒による高所放出を前提とした中央制御室等の運転員の被ばくを評価していることから、保守的に全量が地上放出されるとした場合の運転員の実効線量を評価した。</p> <p>公衆への影響評価での主要解析条件及び敷地等境界外における実効線量の比較を、それぞれ表1及び表2に示す。</p> <p>排気筒破損の影響により、地上放出として評価した結果、敷地等境界外における最大の実効線量は約0.078mSvであり、判断のめやすの実効線量5mSvを超えないことを確認した。</p> <p>また、従事者への影響評価での主要解析条件及び中央制御室における運転員の実効線量の比較を、それぞれ表3、表4、表5、表6及び表7に示す。排気筒破損の影響により、地上放出として評価した結果、中央制御室等における運転員の実効線量は3号炉で約26mSv及び4号炉で約14mSvであり、判断のめやすの実効線量100mSvを超えないことを確認した。</p>		<p>【参考：地上放出時の実効線量評価】</p> <p>竜巻による排気筒損傷と原子炉冷却材喪失事故が重畳したと仮定した場合、本来排気筒から高所放出される気体状の放射性物質を含む内部流体は、フィルタユニット通過後、低所から放出されることになる。このため、公衆又は従業者の被ばくの増加が考えられる。</p> <p>上記のような考え方を元に、公衆への影響評価として、原子炉冷却材喪失時（設計基準事故）を想定し、排気筒により高所放出されず、保守的に全量が地上放出されるとした場合の敷地境界外における実効線量の評価を実施した。</p> <p>また、従事者への影響評価としては、第35回原子力発電所の新規制基準適合性に係る審査会合「資料1-1 泊発電所3号機中央制御室について」（平成25年10月22日）において排気筒による高所放出を前提とした中央制御室等の運転員の被ばくを評価していることから、保守的に全量が地上放出されるとした場合の運転員の実効線量を評価した。</p> <p>公衆への影響評価での主要解析条件及び敷地境界外における実効線量の比較を、それぞれ表1及び表2に示す。</p> <p>排気筒破損の影響により、地上放出として評価した結果、敷地境界外における最大の実効線量は約0.23mSvであり、判断のめやすの実効線量5mSvを超えないことを確認した。</p> <p>また、従事者への影響評価での主要解析条件及び中央制御室における運転員の実効線量の比較を、それぞれ表3、表4及び表5に示す。排気筒破損の影響により、地上放出として評価した結果、中央制御室等における運転員の実効線量は約28mSvであり、判断のめやすの実効線量100mSvを超えないことを確認した。</p>	<p>【大飯】 記載表現の相違</p> <p>【大飯】 資料の相違</p> <p>【大飯】 解析条件の違いによる 評価結果の相違</p> <p>【大飯】 記載方針の相違</p> <p>【大飯】 解析条件の違いによる 評価結果の相違</p>

赤字：設備、運用又は体制の相違（設計方針の相違）
 青字：記載箇所又は記載内容の相違（記載方針の相違）
 緑字：記載表現、設備名称の相違（実質的な相違なし）

第6条 外部からの衝撃による損傷の防止（竜巻：別添資料1 添付資料3.12）

大飯発電所3/4号炉			女川原子力発電所2号炉			泊発電所3号炉			相違理由																																																															
表1 主要解析条件の比較 <table border="1"> <thead> <tr> <th>項目</th> <th>設計基準事故（原子炉冷却材喪失時）の解析条件</th> <th>影響評価における解析条件</th> </tr> </thead> <tbody> <tr> <td>原子炉熱出力</td> <td>3,479 MWt（定格熱出力の102%）</td> <td>同 左</td> </tr> <tr> <td>原子炉運転時間</td> <td>最高40,000時間</td> <td>同 左</td> </tr> <tr> <td>事故後、原子炉格納容器内に放出される核分裂生成物の量</td> <td>炉心内蓄積量の内 希ガス 1% よう素 0.5%</td> <td>同 左</td> </tr> <tr> <td>原子炉格納容器に放出されるよう素の形態</td> <td>有機よう素 4% 無機よう素 96%</td> <td>同 左</td> </tr> <tr> <td>原子炉格納容器に放出される核分裂生成物の内、原子炉格納容器内部に沈着する割合</td> <td>希ガス 0% 有機よう素 0% 無機よう素 50%</td> <td>同 左</td> </tr> <tr> <td>原子炉格納容器スプレイ水による無機よう素除去効率</td> <td>スプレイによるよう素除去に対する等価半減期 無機よう素 50秒 ただし、有機よう素・希ガスについては考慮しない。</td> <td>同 左</td> </tr> <tr> <td>原子炉格納容器スプレイによる除去効果が有効になる時間</td> <td>事故後6分</td> <td>同 左</td> </tr> <tr> <td>原子炉格納容器からの漏えい率</td> <td>次式により求めた値を下回らない値 $L = \frac{C}{V} \sqrt{\frac{\Delta P}{\rho}}$ L：漏えい率 C：定数 V：原子炉格納容器内気相部体積 ΔP：差圧 ρ：原子炉格納容器内気体密度</td> <td>同 左</td> </tr> <tr> <td>原子炉格納容器からの漏えい割合</td> <td>アニュラス部 87% アニュラス部以外 3%</td> <td>同 左</td> </tr> <tr> <td>アニュラス空気浄化設備のよう素フィルタのよう素除去効率</td> <td>95%</td> <td>同 左</td> </tr> </tbody> </table>			項目	設計基準事故（原子炉冷却材喪失時）の解析条件	影響評価における解析条件	原子炉熱出力	3,479 MWt（定格熱出力の102%）	同 左	原子炉運転時間	最高40,000時間	同 左	事故後、原子炉格納容器内に放出される核分裂生成物の量	炉心内蓄積量の内 希ガス 1% よう素 0.5%	同 左	原子炉格納容器に放出されるよう素の形態	有機よう素 4% 無機よう素 96%	同 左	原子炉格納容器に放出される核分裂生成物の内、原子炉格納容器内部に沈着する割合	希ガス 0% 有機よう素 0% 無機よう素 50%	同 左	原子炉格納容器スプレイ水による無機よう素除去効率	スプレイによるよう素除去に対する等価半減期 無機よう素 50秒 ただし、有機よう素・希ガスについては考慮しない。	同 左	原子炉格納容器スプレイによる除去効果が有効になる時間	事故後6分	同 左	原子炉格納容器からの漏えい率	次式により求めた値を下回らない値 $L = \frac{C}{V} \sqrt{\frac{\Delta P}{\rho}}$ L：漏えい率 C：定数 V：原子炉格納容器内気相部体積 ΔP：差圧 ρ：原子炉格納容器内気体密度	同 左	原子炉格納容器からの漏えい割合	アニュラス部 87% アニュラス部以外 3%	同 左	アニュラス空気浄化設備のよう素フィルタのよう素除去効率	95%	同 左	表1 主要解析条件の比較 (1/3) <table border="1"> <thead> <tr> <th>項目</th> <th>設計基準事故（原子炉冷却材喪失時）の解析条件</th> <th>影響評価における解析条件</th> </tr> </thead> <tbody> <tr> <td>炉心熱出力</td> <td>2,705 MWt（定格熱出力の102%）</td> <td>同 左</td> </tr> <tr> <td>原子炉運転時間</td> <td>最高40,000時間</td> <td>同 左</td> </tr> <tr> <td>事故後、原子炉格納容器内に放出される核分裂生成物の量</td> <td>炉心内蓄積量の内 希ガス 1% よう素 0.5%</td> <td>同 左</td> </tr> <tr> <td>原子炉格納容器に放出されるよう素の形態</td> <td>有機よう素 4% 無機よう素 96%</td> <td>同 左</td> </tr> <tr> <td>原子炉格納容器に放出される核分裂生成物の内、原子炉格納容器内部に沈着する割合</td> <td>希ガス 0% 有機よう素 0% 無機よう素 50%</td> <td>同 左</td> </tr> <tr> <td>原子炉格納容器スプレイ水による無機よう素除去効率</td> <td>スプレイによるよう素除去に対する等価半減期 無機よう素 50秒 ただし、有機よう素・希ガスについては考慮しない。</td> <td>同 左</td> </tr> <tr> <td>原子炉格納容器スプレイによる除去効果が有効になる時間</td> <td>事故後5分</td> <td>同 左</td> </tr> <tr> <td>原子炉格納容器からの漏えい率</td> <td>次式により求めた値を下回らない値 $L = \frac{C}{V} \sqrt{\frac{\Delta P}{\rho}}$ L：漏えい率 C：定数 V：原子炉格納容器内気相部体積 ΔP：差圧 ρ：原子炉格納容器内気体密度</td> <td>同 左</td> </tr> <tr> <td>原子炉格納容器からの漏えい割合</td> <td>アニュラス部 97% アニュラス部以外 3%</td> <td>同 左</td> </tr> <tr> <td>アニュラス空気浄化設備のよう素フィルタのよう素除去効率</td> <td>95%</td> <td>同 左</td> </tr> </tbody> </table>			項目	設計基準事故（原子炉冷却材喪失時）の解析条件	影響評価における解析条件	炉心熱出力	2,705 MWt（定格熱出力の102%）	同 左	原子炉運転時間	最高40,000時間	同 左	事故後、原子炉格納容器内に放出される核分裂生成物の量	炉心内蓄積量の内 希ガス 1% よう素 0.5%	同 左	原子炉格納容器に放出されるよう素の形態	有機よう素 4% 無機よう素 96%	同 左	原子炉格納容器に放出される核分裂生成物の内、原子炉格納容器内部に沈着する割合	希ガス 0% 有機よう素 0% 無機よう素 50%	同 左	原子炉格納容器スプレイ水による無機よう素除去効率	スプレイによるよう素除去に対する等価半減期 無機よう素 50秒 ただし、有機よう素・希ガスについては考慮しない。	同 左	原子炉格納容器スプレイによる除去効果が有効になる時間	事故後5分	同 左	原子炉格納容器からの漏えい率	次式により求めた値を下回らない値 $L = \frac{C}{V} \sqrt{\frac{\Delta P}{\rho}}$ L：漏えい率 C：定数 V：原子炉格納容器内気相部体積 ΔP：差圧 ρ：原子炉格納容器内気体密度	同 左	原子炉格納容器からの漏えい割合	アニュラス部 97% アニュラス部以外 3%	同 左	アニュラス空気浄化設備のよう素フィルタのよう素除去効率	95%	同 左	【大飯】 記載方針の相違 【大飯】 解析条件の相違
項目	設計基準事故（原子炉冷却材喪失時）の解析条件	影響評価における解析条件																																																																						
原子炉熱出力	3,479 MWt（定格熱出力の102%）	同 左																																																																						
原子炉運転時間	最高40,000時間	同 左																																																																						
事故後、原子炉格納容器内に放出される核分裂生成物の量	炉心内蓄積量の内 希ガス 1% よう素 0.5%	同 左																																																																						
原子炉格納容器に放出されるよう素の形態	有機よう素 4% 無機よう素 96%	同 左																																																																						
原子炉格納容器に放出される核分裂生成物の内、原子炉格納容器内部に沈着する割合	希ガス 0% 有機よう素 0% 無機よう素 50%	同 左																																																																						
原子炉格納容器スプレイ水による無機よう素除去効率	スプレイによるよう素除去に対する等価半減期 無機よう素 50秒 ただし、有機よう素・希ガスについては考慮しない。	同 左																																																																						
原子炉格納容器スプレイによる除去効果が有効になる時間	事故後6分	同 左																																																																						
原子炉格納容器からの漏えい率	次式により求めた値を下回らない値 $L = \frac{C}{V} \sqrt{\frac{\Delta P}{\rho}}$ L：漏えい率 C：定数 V：原子炉格納容器内気相部体積 ΔP：差圧 ρ：原子炉格納容器内気体密度	同 左																																																																						
原子炉格納容器からの漏えい割合	アニュラス部 87% アニュラス部以外 3%	同 左																																																																						
アニュラス空気浄化設備のよう素フィルタのよう素除去効率	95%	同 左																																																																						
項目	設計基準事故（原子炉冷却材喪失時）の解析条件	影響評価における解析条件																																																																						
炉心熱出力	2,705 MWt（定格熱出力の102%）	同 左																																																																						
原子炉運転時間	最高40,000時間	同 左																																																																						
事故後、原子炉格納容器内に放出される核分裂生成物の量	炉心内蓄積量の内 希ガス 1% よう素 0.5%	同 左																																																																						
原子炉格納容器に放出されるよう素の形態	有機よう素 4% 無機よう素 96%	同 左																																																																						
原子炉格納容器に放出される核分裂生成物の内、原子炉格納容器内部に沈着する割合	希ガス 0% 有機よう素 0% 無機よう素 50%	同 左																																																																						
原子炉格納容器スプレイ水による無機よう素除去効率	スプレイによるよう素除去に対する等価半減期 無機よう素 50秒 ただし、有機よう素・希ガスについては考慮しない。	同 左																																																																						
原子炉格納容器スプレイによる除去効果が有効になる時間	事故後5分	同 左																																																																						
原子炉格納容器からの漏えい率	次式により求めた値を下回らない値 $L = \frac{C}{V} \sqrt{\frac{\Delta P}{\rho}}$ L：漏えい率 C：定数 V：原子炉格納容器内気相部体積 ΔP：差圧 ρ：原子炉格納容器内気体密度	同 左																																																																						
原子炉格納容器からの漏えい割合	アニュラス部 97% アニュラス部以外 3%	同 左																																																																						
アニュラス空気浄化設備のよう素フィルタのよう素除去効率	95%	同 左																																																																						

赤字：設備、運用又は体制の相違（設計方針の相違）
 青字：記載箇所又は記載内容の相違（記載方針の相違）
 緑字：記載表現、設備名称の相違（実質的な相違なし）

第6条 外部からの衝撃による損傷の防止（竜巻：別添資料1 添付資料3.12）

大飯発電所3/4号炉		女川原子力発電所2号炉		泊発電所3号炉		相違理由
表1 主要解析条件の比較 [続き]				表1 主要解析条件の比較 [2/3]		【大飯】 記載方針の相違 【大飯】 解析条件の相違
項目	設計基準事故（原子炉冷却材喪失時）の解析条件	影響評価における解析条件	項目	設計基準事故（原子炉冷却材喪失時）の解析条件	影響評価における解析条件	
アンユラス部の負圧達成までのよう素フィルタのよう素除去効率	10～20分 アンユラス空気浄化設備を通じて全量排気筒放出（フィルタの効果は考慮しない）	同 左	アンユラス部の負圧達成までのよう素フィルタのよう素除去効率	9～10分 アンユラス空気浄化設備を通じて全量排気筒放出（フィルタの効果は考慮しない）	同 左	【大飯】 評価結果の相違
負圧達成後のアンユラス排気風量	12分～30日 アンユラス空気浄化設備を通じてファン容量の約46%が排気筒放出（フィルタの効果を考慮する）	同 左	負圧達成後のアンユラス排気風量	10分～30分 アンユラス空気浄化設備を通じてファン容量で排気筒放出（フィルタの効果を考慮する）	同 左	
再循環系から安全補機室内への漏えい率	4×10^{-3} m ³ /h	同 左	再循環系から安全補機室内への漏えい率	4×10^{-3} m ³ /h	同 左	
再循環開始時間	事故後 20 分	同 左	再循環開始時間	事故後 20 分	同 左	
再循環水中の放射エネルギー	炉心内よう素蓄積量の0.5%	同 左	再循環水中の放射エネルギー	炉心内よう素蓄積量の0.5%	同 左	
再循環水体積	1,600m ³	同 左	再循環水体積	1,400m ³	同 左	
再循環系から安全補機室内に漏えいた再循環水中のよう素の気相への移行率	5%	同 左	再循環系から安全補機室内に漏えいた再循環水中のよう素の気相への移行率	5%	同 左	
安全補機室内でのよう素沈着率	50%	同 左	安全補機室内でのよう素沈着率	50%	同 左	
事故の評価期間	30 日	同 左	事故の評価期間	30 日	同 左	
環境に放出された放射性物質大気中の拡散条件	1983年1月～1983年12月の気象データに基づき「発電用原子炉施設の安全解析に関する気象指針」に従って評価された相対濃度（ x/Q ）および相対線量（ D/Q ） ・排気筒放出 x/Q : 約 6.7×10^{-5} s/m ³ D/Q : 約 1.3×10^{-19} Gy/Bq ・地上放出 x/Q : 約 1.6×10^{-8} s/m ³ D/Q : 約 2.9×10^{-19} Gy/Bq	1983年1月～1983年12月の気象データに基づき「発電用原子炉施設の安全解析に関する気象指針」に従って評価された相対濃度（ x/Q ）および相対線量（ D/Q ） ・地上放出 x/Q : 約 1.7×10^{-5} s/m ³ D/Q : 約 4.0×10^{-19} Gy/Bq	環境に放出された放射性物質大気中の拡散条件	1997年1月～1997年12月の気象データに基づき「発電用原子炉施設の安全解析に関する気象指針」に従って評価された相対濃度（ x/Q ）及び相対線量（ D/Q ） ・排気筒放出 x/Q : 4.3×10^{-5} s/m ³ D/Q : 3.1×10^{-19} Gy/Bq	1997年1月～1997年12月の気象データに基づき「発電用原子炉施設の安全解析に関する気象指針」に従って評価された相対濃度（ x/Q ）及び相対線量（ D/Q ） ・地上放出 x/Q : 4.5×10^{-8} s/m ³ D/Q : 3.1×10^{-19} Gy/Bq	
表1 主要解析条件の比較 [既記]				表1 主要解析条件の比較 [3/3]		【大飯】 記載方針の相違
項目	設計基準事故（原子炉冷却材喪失時）の解析条件	影響評価における解析条件	項目	設計基準事故（原子炉冷却材喪失時）の解析条件	影響評価における解析条件	
線量換算係数	よう素の吸入摂取に対して、小児実効線量換算係数を使用 I-131: 1.6×10^{-7} Sv/Bq I-132: 2.3×10^{-8} Sv/Bq I-133: 4.1×10^{-8} Sv/Bq I-134: 6.9×10^{-10} Sv/Bq I-135: 8.5×10^{-9} Sv/Bq	同 左	線量換算係数	よう素の吸入摂取に対して、小児実効線量換算係数を使用 I-131: 1.6×10^{-7} Sv/Bq I-132: 2.3×10^{-8} Sv/Bq I-133: 4.1×10^{-8} Sv/Bq I-134: 6.9×10^{-10} Sv/Bq I-135: 8.5×10^{-9} Sv/Bq	同 左	【大飯】 記載方針の相違
呼吸率	小児1日平均の呼吸率 5.16 m ³ /d	同 左	呼吸率	小児1日平均の呼吸率 5.16 m ³ /d	同 左	

赤字：設備、運用又は体制の相違（設計方針の相違）
 青字：記載箇所又は記載内容の相違（記載方針の相違）
 緑字：記載表現、設備名称の相違（実質的な相違なし）

第6条 外部からの衝撃による損傷の防止（竜巻：別添資料1 添付資料3.12）

大飯発電所3/4号炉			女川原子力発電所2号炉			泊発電所3号炉			相違理由	
表2 評価結果の比較						表2 評価結果の比較				
評価項目	設計基準事故 (原子炉冷却材喪失時)の評価結果	影響評価結果				評価項目	設計基準事故 (原子炉冷却材喪失時)の評価結果	影響評価結果		
よう素の放出量 (I-131等価量・小児実効線量係数換算)	現行評価経路	約 1.4×10^{11} Bq	—			よう素の放出量 (I-131等価量・小児実効線量係数換算)	現行評価経路 (排気筒放出)	約 2.7×10^{11} Bq	—	
	地上放出	約 1.5×10^{11} Bq	—				排気筒破損により地上放出	—	約 2.7×10^{11} Bq	
	排気筒破損により地上放出	—	約 2.9×10^{11} Bq							
希ガスの放出量 (γ線=44kV・0.5MeV換算)	現行評価経路	約 5.7×10^{13} Bq	—			希ガスの放出量 (γ線=44kV・0.5MeV換算)	現行評価経路 (排気筒放出)	約 6.1×10^{13} Bq	—	
	地上放出	約 2.6×10^{13} Bq	—				排気筒破損により地上放出	—	約 6.1×10^{13} Bq	
	排気筒破損により地上放出	—	約 6.0×10^{13} Bq							
被ばく線量(実効線量)	約0.051 mSv	約0.075 mSv				被ばく線量(実効線量)	約0.23 mSv	約0.23 mSv		
(参考) 上記被ばく線量のうち 直接・スカイシャイン線量	約 9.8×10^{-3} mSv	約 5.4×10^{-3} mSv				上記被ばく線量のうち 直接・スカイシャイン線量	約0.086 mSv	同左		
表3 主要解析条件の比較						表3 主要解析条件の比較				
項目	中央制御室(設計基準事故)居住性評価に係る被ばく評価の相対濃度及び相対線量	影響評価における評価の相対濃度及び相対線量				項目	中央制御室(設計基準事故)居住性評価に係る被ばく評価の相対濃度及び相対線量	影響評価における解析条件		
放出源及び放出高さ	排気筒 73m	地上 0m				放出源及び放出高さ	排気筒 73.1m	地上 0m		
表4 大気拡散条件の比較(3号炉)						表4 大気拡散条件の比較				
評価対象	評価点	項目	中央制御室(設計基準事故)居住性評価に係る被ばく評価の相対濃度及び相対線量	影響評価における評価の相対濃度及び相対線量		評価対象	評価点	項目	中央制御室(設計基準事故)居住性評価に係る被ばく評価の相対濃度及び相対線量	影響評価における評価の相対濃度及び相対線量
室内作業時	中央制御室中心	相対濃度(希ガス)	約 2.0×10^{-4} s/m ³	約 4.0×10^{-4} s/m ³		室内作業時	中央制御室中心	相対濃度(希ガス)	1.5×10^{-4} s/m ³	3.0×10^{-4} s/m ³
		相対濃度(よう素)	約 2.0×10^{-4} s/m ³	約 3.9×10^{-4} s/m ³				相対濃度(よう素)	4.6×10^{-4} s/m ³	3.3×10^{-4} s/m ³
		相対線量	約 1.3×10^{-17} Gy/Bq	同左				相対線量	1.1×10^{-17} Gy/Bq	同左
入退域時	正門	相対濃度	約 9.5×10^{-3} s/m ³	約 1.9×10^{-4} s/m ³		入退域時	出入管理建屋入口	相対濃度	1.1×10^{-4} s/m ³	2.3×10^{-4} s/m ³
		相対線量	約 2.3×10^{-18} Gy/Bq	同左				相対線量	4.2×10^{-18} Gy/Bq	同左
	事務所入口	相対濃度	約 6.8×10^{-3} s/m ³	約 1.4×10^{-4} s/m ³			中央制御室入口	相対濃度	1.7×10^{-4} s/m ³	3.4×10^{-4} s/m ³
		相対線量	約 2.6×10^{-18} Gy/Bq	同左				相対線量	1.3×10^{-17} Gy/Bq	同左
	中央制御室入口	相対濃度	約 2.2×10^{-4} s/m ³	約 4.4×10^{-4} s/m ³						
相対線量	約 1.2×10^{-17} Gy/Bq	同左								

【大飯】
評価結果の相違

【大飯】
解析条件の相違

【大飯】
評価結果の相違

赤字：設備、運用又は体制の相違（設計方針の相違）
 青字：記載箇所又は記載内容の相違（記載方針の相違）
 緑字：記載表現、設備名称の相違（実質的な相違なし）

大飯発電所3/4号炉

女川原子力発電所2号炉

泊発電所3号炉

相違理由

表5 大気拡散条件の比較（4号炉）

評価対象	評価点	項目	中央制御室（設計基準事故） 居住性評価に係る被ばく評 価の相対濃度及び相対線量	影響評価における評価の 相対濃度及び相対線量	
室内作業時	中央制御室中心	相対濃度 （希ガス）	約 1.2×10^{-4} s/m ³	約 2.4×10^{-4} s/m ³	
		相対濃度 （より素）	約 1.1×10^{-4} s/m ³	約 2.2×10^{-4} s/m ³	
		相対線量	約 7.3×10^{-10} Gy/Bq	同左	
入退域時	正門	相対濃度	約 3.4×10^{-2} s/m ³	約 6.8×10^{-2} s/m ³	
		相対線量	約 9.7×10^{-10} Gy/Bq	同左	
	事務所入口	相対濃度	約 3.6×10^{-2} s/m ³	約 7.1×10^{-2} s/m ³	
		相対線量	約 1.1×10^{-9} Gy/Bq	同左	
		中央制御室入口	相対濃度	約 7.0×10^{-2} s/m ³	約 1.4×10^{-1} s/m ³
			相対線量	約 3.1×10^{-9} Gy/Bq	同左

表6 中央制御室居住性に係る被ばく評価結果の比較（3号炉）（mSv）

被ばく経路	中央制御室（設計基準事故） 居住性評価に係る被ばく評 価の相対濃度及び相対線量	影響評価における評価の 相対濃度及び相対線量	
室内作業時	①建屋からのガンマ線による中央制 御室内での被ばく	約 3.1×10^0	同左
	②大気中へ放出された放射性物質のガ ンマ線による中央制御室内での被ば く	約 3.7×10^{-1}	同左
	③室内に外気から取り込まれた放射 性物質による中央制御室内での被ば く	約 7.1×10^0	約 1.4×10^1
	小 計（①+②+③）	約 7.5×10^0	約 1.5×10^1
入退域時	④建屋からのガンマ線による入退域 時の被ばく	約 8.2×10^0	同左
	⑤大気中へ放出された放射性物質によ る入退域時の被ばく	約 1.5×10^0	約 2.6×10^0
	小 計（④+⑤）	約 9.8×10^0	約 1.1×10^1
合 計（①+②+③+④+⑤）	約 18	約 26	

注）上記の被ばく経路①～⑤は、図1に示す通り被ばく経路①～⑤に対応している。

表7 中央制御室居住性に係る被ばく評価結果の比較（4号炉）（mSv）

被ばく経路	中央制御室（設計基準事故） 居住性評価に係る被ばく評 価の相対濃度及び相対線量	影響評価における評価の 相対濃度及び相対線量	
室内作業時	①建屋からのガンマ線による中央制 御室内での被ばく	約 3.1×10^0	同左
	②大気中へ放出された放射性物質のガ ンマ線による中央制御室内での被ば く	約 2.2×10^{-1}	同左
	③室内に外気から取り込まれた放射 性物質による中央制御室内での被ば く	約 4.1×10^0	約 8.2×10^0
	小 計（①+②+③）	約 4.4×10^0	約 8.5×10^0
入退域時	④建屋からのガンマ線による入退域 時の被ばく	約 3.7×10^0	同左
	⑤大気中へ放出された放射性物質によ る入退域時の被ばく	約 5.1×10^{-1}	約 8.8×10^{-1}
	小 計（④+⑤）	約 4.2×10^0	約 4.6×10^0
合 計（①+②+③+④+⑤）	約 8.6	約 14	

注）上記の被ばく経路①～⑤は、図1に示す通り被ばく経路①～⑤に対応している。

表5 中央制御室居住性に係る被ばく評価結果の比較（mSv）

被ばく経路	中央制御室（設計基準事故） 居住性評価に係る被ばく評 価結果	影響 評 価 結 果	
室内作業時	①建屋からのガンマ線による中央制 御室内での被ばく	約 3.5×10^0	同 左
	②大気中へ放出された放射性物質の ガンマ線による中央制御室内での 被ばく	約 1.7×10^{-1}	同 左
	③室内に外気から取り込まれた放射 性物質による中央制御室内での被 ばく	約 8.9×10^0	約 1.8×10^1
	小 計（①+②+③）	約 9.2×10^0	約 1.8×10^1
入退域時	④建屋からのガンマ線による入退域 時の被ばく	約 6.4×10^0	同 左
	⑤大気中へ放出された放射性物質に よる入退域時の被ばく	約 1.9×10^0	約 3.1×10^0
	小 計（④+⑤）	約 8.3×10^0	約 9.5×10^0
合 計（①+②+③+④+⑤）	約 18	約 28	

注）上記の被ばく経路①～⑤は、図-1に示す通り被ばく経路①～⑤に対応している。

【大飯】
 記載内容の相違
 大飯は、3号炉及び4号炉の申請であるため、2つの比較結果が記載されているが、泊は3号炉のみの申請であるため、比較結果は一つであるため、対応する表はない。

【大飯】
 評価結果の相違

【大飯】
 記載内容の相違
 大飯は、3号炉及び4号炉の申請であるため、2つの比較結果が記載されているが、泊は3号炉のみの申請であるため、比較結果は一つため、対応する表はない。

赤字：設備、運用又は体制の相違（設計方針の相違）
 青字：記載箇所又は記載内容の相違（記載方針の相違）
 緑字：記載表現、設備名称の相違（実質的な相違なし）

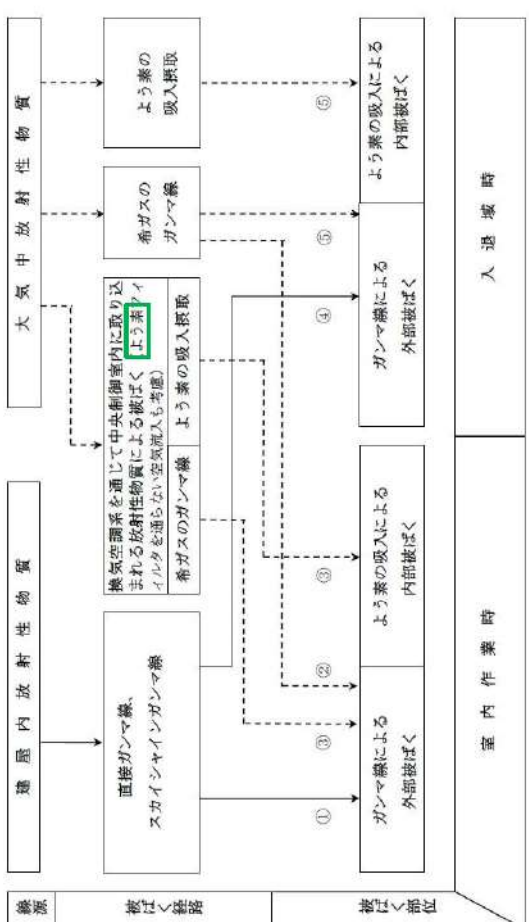
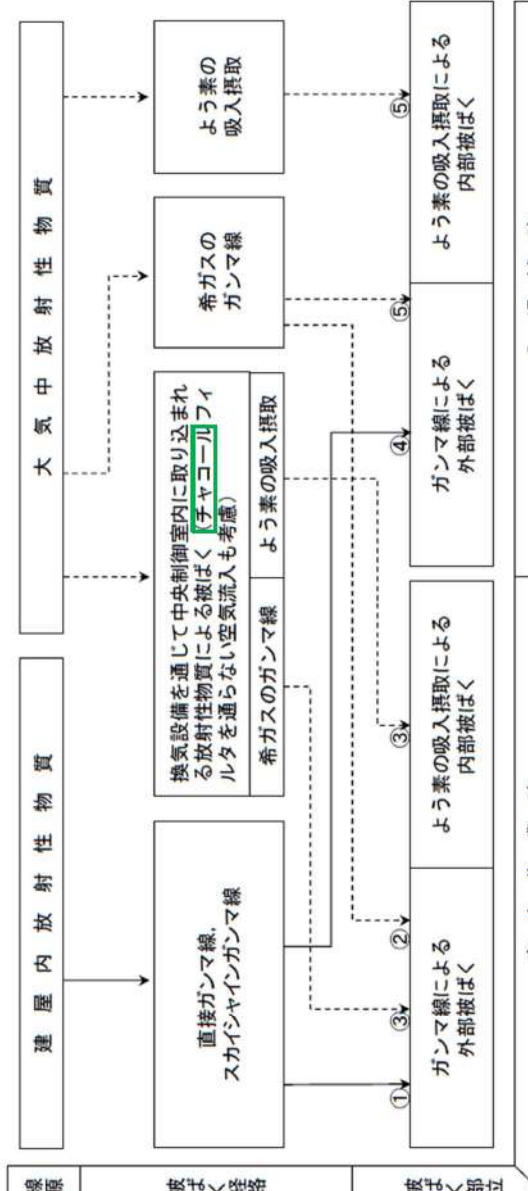
大飯発電所3/4号炉	女川原子力発電所2号炉	泊発電所3号炉	相違理由
 <p>線源 被ばく経路 被ばく部位</p> <p>建屋内放射線物質</p> <p>大気中放射線物質</p> <p>室内作業時</p> <p>入退域時</p> <p>図1 事故時における中央制御室等の従事者の被ばく経路</p>	<p>線源 被ばく経路 被ばく部位</p> <p>建屋内放射線物質</p> <p>大気中放射線物質</p> <p>室内作業時</p> <p>入退域時</p> <p>図1 事故時における中央制御室等の従事者の被ばく経路</p>	 <p>線源 被ばく経路 被ばく部位</p> <p>建屋内放射線物質</p> <p>大気中放射線物質</p> <p>室内作業時</p> <p>入退域時</p> <p>図1 事故時における中央制御室等の従事者の被ばく経路</p>	<p>【大飯】 記載表現の相違 （語句の表現の相違はあるが、フローに相違はない。）</p>

赤字：設備、運用又は体制の相違（設計方針の相違）
 青字：記載箇所又は記載内容の相違（記載方針の相違）
 緑字：記載表現、設備名称の相違（実質的な相違なし）

第6条 外部からの衝撃による損傷の防止（竜巻：別添資料1 添付資料3.13）

大飯発電所3/4号炉	女川原子力発電所2号炉	泊発電所3号炉	相違理由
<p>1.3. 竜巻防護対策の概要について</p> <p style="text-align: right;">別紙1</p> <p>竜巻防護施設を飛来物から防護するための防護ネット（金網）の基本設計について</p> <p>竜巻による飛来物から防護対象設備を護るため、その周囲に防護壁（鋼板）、防護ネットを設置することとしている。その基本設計について以下に説明する。</p> <p>1. 基本設計方針</p> <p>(1) 防護対象飛来物 防護対象飛来物は、設計飛来物の内、最もエネルギーの大きい鋼製材とする。また、防護ネットの設置に際しては、ネットの網目を抜ける可能性のある鋼製パイプ（直径50mm）についても考慮する。</p> <p>(2) 防護鋼板の設計 防護鋼板の設置に際しては、鋼製材の鋼板に対する貫通限界厚さを考慮し、水平方向の防護壁については11mm以上、鉛直方向の防護壁については7mm以上の厚みとする。</p> <p>(3) 防護壁の設計 防護壁の設置に際しては、鋼製材の鉄筋コンクリートに対する貫通限界厚さを考慮し、水平、鉛直方向ともにFc40N/mm²の強度にて500mm以上厚みとする。</p> <p>(4) 防護ネットの設計 高強度金網については、竜巻防護対象施設および開口部を囲う鉄骨構造物を設置し、その上にH形鋼等を用いたフレームに取付けた金網を設置する。フレームへの金網の取付け部については、金網の4辺をワイヤーロープで支持し、ワイヤーの両端をフレームにボルトで締結する構造とする。</p> <p>(5) 架構の設計 防護ネット及び防護鋼板を支持する架構については、飛来物が衝突した際に、防護鋼板および防護ネットが脱落せず、また飛来物の衝突により、架構が倒壊し、防護対象施設に波及的影響を与えない構造とする。</p> <p>(6) 耐震上の考慮 竜巻飛来物防護対策設備は、竜巻による飛来物から竜巻防護施設を防護するためのものであり、地震時にはその機能を求められないことから耐震性の要求はない。しかしながら、防護対象施設は地震時にもその安全機能を要求される設備であることから、地震時の竜巻飛来物防護対策設備による波及的影響を防止する必要がある。このため、地震時に損壊等により竜巻防護施設に波及的影響を及ぼさないことを確認する。</p> <p>(7) 風荷重に対する考慮 竜巻襲来時には竜巻の風荷重により防護ネットがたわむ事となる。</p>	<p style="text-align: right;">添付資料 3.7</p> <p>竜巻防護ネットの構造設計について</p> <p>1. 概要 設置許可基準規則第六条において、外部からの衝撃による損傷の防止として、安全施設は想定される自然現象（地震及び津波を除く。）が発生した場合においても安全機能を損なわないものでなければならないとしており、敷地周辺の自然環境を基に想定される自然現象の一つとして、竜巻の影響を挙げている。 外部事象防護対象施設である原子炉補機冷却海水ポンプ（電動機、配管等を含む）及び高圧炉心スプレイ補機冷却海水ポンプ（電動機、配管等を含む）（以下、「非常用海水ポンプ等」という。）は、想定される自然現象のうち、竜巻による設計飛来物の衝突により安全機能を損なうおそれがあることから、竜巻防護ネットによる防護対策を講じることで損傷を防止し、安全機能が損なわれない設計とする。</p> <p>2. 竜巻防護ネットに対する要求事項 竜巻防護ネットは竜巻から非常用海水ポンプを防護する観点で、以下の要求事項を満足する必要がある。</p> <p>(1) 竜巻防護に対する要求事項 ・竜巻の風荷重や設計飛来物が衝突した際の衝撃力等に耐え、設計飛来物が非常用海水ポンプ等に到達しないこと。 ・設計飛来物が衝突した際に構造体が崩壊及び落下せず、非常用海水ポンプ等を損傷させないこと。</p> <p>(2) 竜巻以外の自然現象（地震、津波含む）に対する要求事項 ・竜巻以外の自然現象によって構造体が崩壊及び落下せず、非常用海水ポンプ等に波及的影響を及ぼさないこと。</p> <p>(3) 竜巻随伴事象に対する要求事項 ・竜巻随伴事象として想定される事象である、火災、溢水及び外部電源喪失に対し、非常用海水ポンプ等に波及的影響を及ぼさないこと。 ・竜巻防護ネット自体が、火災、溢水及び外部電源喪失の原因とならないこと。</p> <p>3. 設計方針</p> <p>3.1 竜巻防護ネットの構造</p> <p>3.1.1 設置位置 竜巻防護ネットは、海水ポンプ室補機ポンプエリアに設置する。</p>	<p style="text-align: right;">添付資料 3.13</p> <p>竜巻防護ネットの構造設計について</p> <p>1. 概要 設置許可基準規則第六条において、外部からの衝撃による損傷の防止として、安全施設は想定される自然現象（地震及び津波を除く。）が発生した場合においても安全機能を損なわないものでなければならないとしており、敷地周辺の自然環境を基に想定される自然現象の一つとして、竜巻の影響を挙げている。 外部事象防護対象施設である原子炉補機冷却海水ポンプ（電動機、配管等を含む）及び原子炉補機冷却海水ポンプ出口ストレーナ（配管、弁等を含む）（以下、「原子炉補機冷却海水ポンプ等」という。）は、想定される自然現象のうち、竜巻による設計飛来物の衝突により安全機能を損なうおそれがあることから、竜巻防護ネットによる防護対策を講じることで損傷を防止し、安全機能が損なわれない設計とする。</p> <p>2. 竜巻防護ネットに対する要求事項 竜巻防護ネットは竜巻から原子炉補機冷却海水ポンプ等を防護する観点で、以下の要求事項を満足する必要がある。</p> <p>(1) 竜巻防護に対する要求事項 ・竜巻の風荷重や設計飛来物が衝突した際の衝撃力等に耐え、設計飛来物が原子炉補機冷却海水ポンプ等に到達しないこと。 ・設計飛来物が衝突した際に架台等が崩壊及び落下せず、原子炉補機冷却海水ポンプ等を損傷させないこと。</p> <p>(2) 竜巻以外の自然現象（地震、津波含む）に対する要求事項 ・竜巻以外の自然現象によって架台等が崩壊及び落下せず、原子炉補機冷却海水ポンプ等に波及的影響を及ぼさないこと。</p> <p>(3) 竜巻随伴事象に対する要求事項 ・竜巻随伴事象として想定される事象である、火災、溢水及び外部電源喪失に対し、原子炉補機冷却海水ポンプ等に波及的影響を及ぼさないこと。 ・竜巻防護ネット自体が、火災、溢水及び外部電源喪失の原因とならないこと。</p> <p>3. 設計方針</p> <p>3.1 竜巻防護ネットの構造</p> <p>3.1.1 設置位置 竜巻防護ネットは、循環水ポンプ建屋内にある取水ビットポンプ室内の原子炉補機冷却海水ポンプエリア（以下、「海水ポンプエリア」）</p>	<p>【大飯】 ・記載方針の相違 ・女川審査実績の反映</p> <p>【女川】 記載表現の相違</p> <p>【女川】 竜巻防護ネットで防護する対象機器の相違</p> <p>【女川】 竜巻防護ネットで防護する対象機器の相違</p> <p>【女川】 竜巻防護ネットで防護する対象機器の相違</p> <p>【女川】 竜巻防護ネットで防護する対象機器の相違</p> <p>【女川】 設置場所の相違</p>

赤字：設備、運用又は体制の相違（設計方針の相違）
 青字：記載箇所又は記載内容の相違（記載方針の相違）
 緑字：記載表現、設備名称の相違（実質的な相違なし）

第6条 外部からの衝撃による損傷の防止（竜巻：別添資料1 添付資料3.13）

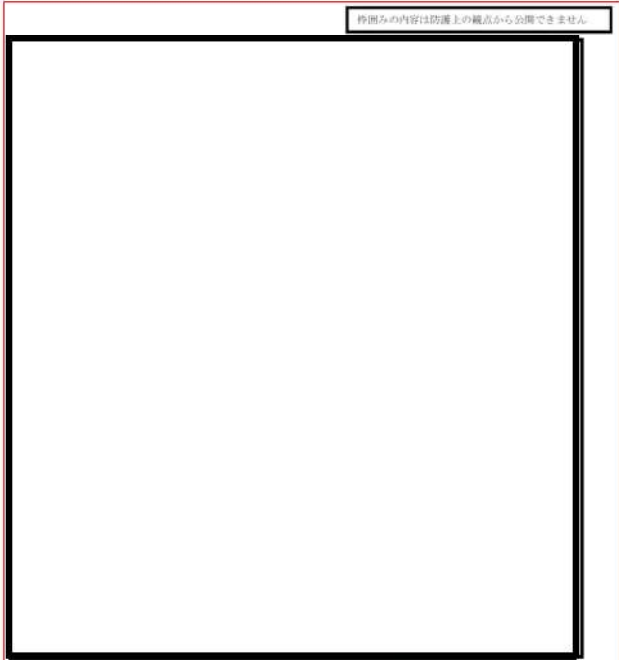
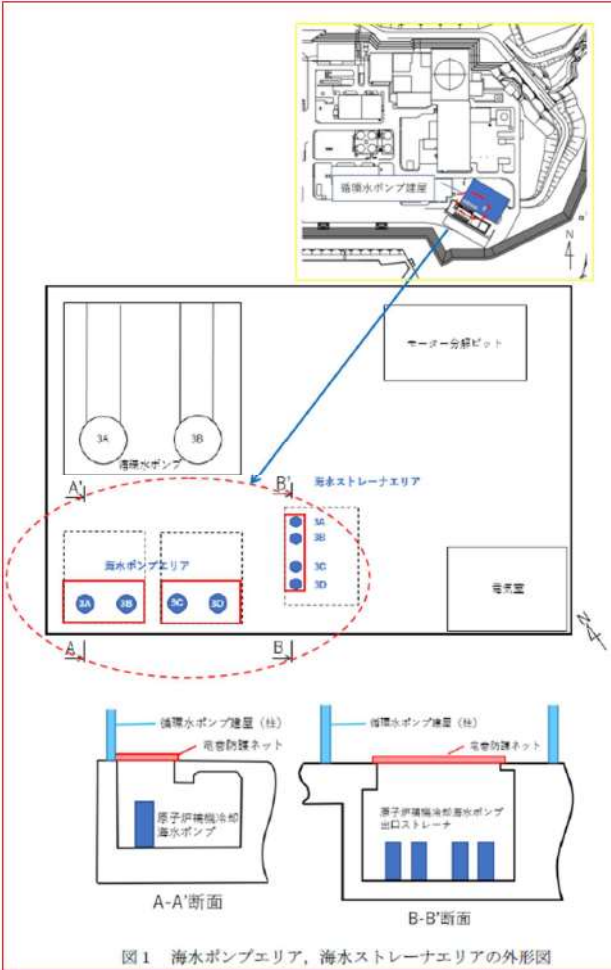
大飯発電所3/4号炉	女川原子力発電所2号炉	泊発電所3号炉	相違理由
<p>一方、防護ネットは、ネットがたわむことによりエネルギーを吸収するため、風荷重により防護ネットがたわんでいると、そのたわみ量に応じて吸収できるエネルギーが減少することとなる。このため、防護ネットの設計に際しては、竜巻襲来時の風荷重を考慮する。</p> <p>(8) 鋼製パイプに対する対応 鋼製パイプが、飛来物防護対策設備内部に侵入することを防止するため、竜巻飛来物防護対策設備では、網間40mmの防護ネットを設置し、鋼製パイプ（直径50mm）がネットの網目を抜けることを防止する。</p> <p>(9) 竜巻防護施設の保守性に対する考慮 海水ポンプは、点検、保守のためにモータおよびポンプを吊り上げる必要がある。このため、海水ポンプの上部に設置する防護ネットについては、防護ネットを取付けたフレーム毎に取り外しが可能な設計とする。また、ロータリースクリーン等の点検、保守時に吊り上げが必要となる設備の上部に設置する防護ネットについても、取り外し可能な設計とする。</p> <p>また、防護壁（鋼板）、防護ネットおよび架構と竜巻防護施設とは、作業員の点検、保守時のアクセス性を考慮した離隔距離を確保する設計とする。</p> <p>(10) 防護ネットの保守管理 防護ネットは、ネットがたわむことによりエネルギーを吸収するため、ネットに過剰な初期たわみや変形があると十分な性能を発揮できない恐れがある。そのため、定期的なネットのたわみ量測定、目視によるネットの変形有無の確認を実施し、異常があった場合には、防護ネットの交換ができる設計とする。</p>	<p>防護対象である非常用海水ポンプ等は、図1に示すように、ピット構造である海水ポンプ室補機ポンプエリア内の全域に及ぶことから、竜巻防護ネットはピット開口部の全面に設置する。</p>  <p>図1 海水ポンプ室補機ポンプエリアの外形図</p> <p>3.1.2 構造概要 竜巻防護ネットは海水ポンプ室補機ポンプエリア開口部に対し、フレームに取り付けたネット（金網）を配置することで、設計飛来物の侵入を阻止し、非常用海水ポンプ等を防護する構造である。</p>	<p>という。)及び原子炉補機冷却海水ポンプ出口ストレーナ室ストレーナエリア（以下、「海水ストレーナエリア」という。）に設置する。</p> <p>防護対象である原子炉補機冷却海水ポンプ等は、図1に示すように、ピット構造である海水ポンプエリア及び海水ストレーナエリア内の全域に及ぶことから、竜巻防護ネットはピット開口部の全面に設置する。</p>  <p>図1 海水ポンプエリア、海水ストレーナエリアの外形図</p> <p>3.1.2 構造概要 竜巻防護ネットは海水ポンプエリア及び海水ストレーナエリア開口部に対し、架台に取り付けたネットを配置することで、設計飛来物の侵入を阻止し、原子炉補機冷却海水ポンプ等を防護する構造である。</p>	<p>相違理由</p> <ul style="list-style-type: none"> 【大阪】 <ul style="list-style-type: none"> ・記載方針の相違 ・女川審査実績の反映 【女川】 <ul style="list-style-type: none"> 設置場所の相違 【女川】 <ul style="list-style-type: none"> 設置場所の相違

泊発電所3号炉 DB基準適合性 比較表

赤字：設備、運用又は体制の相違（設計方針の相違）
 青字：記載箇所又は記載内容の相違（記載方針の相違）
 緑字：記載表現、設備名称の相違（実質的な相違なし）

第6条 外部からの衝撃による損傷の防止（竜巻：別添資料1 添付資料3.13）

大飯発電所3/4号炉	女川原子力発電所2号炉	泊発電所3号炉	相違理由
	<p>海水ポンプ室補機ポンプエリアの隔壁（南側）は壁厚が薄くフレームを支持できないため、フレーム支持用の大梁を設置し、この大梁と隔壁（北側）天面にネット及び防護板を取り付けたフレームを支持する。</p> <p>また、大梁とフレームとの接続部には可動支承を設置し、ブラケットと大梁の接続部及び隔壁（北側）とフレームとの接続部にはゴム支承を設置する。</p> <p>ゴム支承は、地震により生ずる応力及び反力を低減・分散させることを目的としており、水平方向の固有周期を長周期側に移動させ応答を下げるとともに、壁面へ伝達させる荷重を分散させる効果を期待する。</p> <p>可動支承は、温度変化によるフレームの伸縮を吸収し、変形による荷重発生を防ぐため、水平変位に追従する機能を有する。</p> <p>また、フレームにはストッパーを取り付けており、フレームを支持するゴム支承に期待しない場合でも、竜巻防護ネットが落下せず、非常用海水ポンプ等に波及的影響を与えない設計とする。</p> <p>フレームは海水ポンプ室補機ポンプエリアの北側隔壁（厚さ1.5m）に対して約1.2m重なる構造とし、南側隔壁（厚さ0.6m）に対しても約0.55m重なる構造とし、海水ポンプ室補機ポンプエリアに落下しない構造とする。</p> <p>竜巻防護ネットの構造概要を図2及び図3に示す。また、竜巻防護ネットの仕様を表1に示す。なお、仕様は詳細設計により変更もあり得る。</p>	<p>ネットについては、原子炉補機冷却海水ポンプ等の設備点検時の竜巻防護ネットの取り外しの作業性及びネット1面の縦横の寸法の比は、電中研報告書にて適用性が確認されている範囲（1：1～2：1）に入る必要があることを考慮し、開口部に対して2組設置することとしており、2組のネットが接する位置に設計飛来物の鋼製材が衝突した場合は、当該部位の変形により鋼製材がすり抜ける可能性があるため、外部事象防護対象施設である原子炉補機冷却海水ポンプ等に影響を与えないよう、当該部位にすり抜け防止用鋼材（平板+アングル材）を設置する計画である。</p> <p>竜巻防護ネットは主にネット（金網部）の目合いが変形し飛来物の衝突荷重によるエネルギーを吸収することで設計飛来物の侵入を阻止する構造である。</p> <p>海水ストレーナエリア上部開口は海水ポンプエリア上部開口に対して面積が小さいことから、海水ポンプエリア上部と同じ目合い寸法のネットを採用した場合は、目合いの数が減少するためネットの吸収可能エネルギーも小さくなり、設計の裕度が小さくなる。</p> <p>そのため、海水ストレーナエリア上部開口には、目合い寸法の小さい40mmのネットを採用し目合いの数を確保することで海水ポンプエリア上部開口に設置する竜巻防護ネットと同等の裕度を確保する計画である。</p> <p>竜巻防護ネットの構造概要を図2及び図3に示す。また、竜巻防護ネットの仕様を表1に示す。なお、仕様は詳細設計により変更もあり得る。</p>	<p>【女川】</p> <ul style="list-style-type: none"> ・竜巻防護設備の構造の相違。 ・女川は竜巻防護ネットを設置する海水ポンプエリアの壁が薄く支持機能に期待できないため、可動支承、ゴム支承を採用して地震により生じる応力を低減・分散させる構造として、ネットの支持機能を確保している。 ・泊においては、女川と異なり竜巻防護ネットは強固な建屋床面、ブラケットを介してビット壁面に設置できる環境であることから、女川の竜巻防護ネットの可動支承のような可動式の機構を持たせる必要はない。 ・以上の理由から、泊の竜巻防護ネットは、先行プラント（大飯、高浜）と同様の竜巻防護ネットの構造を採用しており、架構に直接、竜巻防護ネットを設置する構造としている。 ・ネットの目合い寸法の使い分けについて記載の充実

赤字：設備、運用又は体制の相違（設計方針の相違）
 青字：記載箇所又は記載内容の相違（記載方針の相違）
 緑字：記載表現、設備名称の相違（実質的な相違なし）

大飯発電所3/4号炉	女川原子力発電所2号炉	泊発電所3号炉	相違理由
	<p>図2 竜巻防護ネットの概要図</p>	<p>図2 海水ポンプエリア、海水ストレーナエリア開口部に設置する防護ネットのイメージ図</p> <p>海水ポンプエリア、海水ストレーナエリアの竜巻防護ネット設置イメージ</p> <p>図3 竜巻防護ネットの構造イメージ</p>	<p>【女川】 防護ネットの設置環境の違いによる構造の相違</p> <p>【女川】 防護ネットの設置環境の違いによる構造の相違</p>
	<p>図3 竜巻防護ネットの概要図（北西側から見た場合）</p>		

赤字：設備、運用又は体制の相違（設計方針の相違）
 青字：記載箇所又は記載内容の相違（記載方針の相違）
 緑字：記載表現、設備名称の相違（実質的な相違なし）

大飯発電所3/4号炉	女川原子力発電所2号炉	泊発電所3号炉	相違理由																																																																																															
	<p style="text-align: center;">表1 竜巻防護ネットの仕様</p> <table border="1" style="width: 100%; border-collapse: collapse;"> <tr> <td>総質量</td> <td>約500ton</td> </tr> <tr> <td>全体形状</td> <td>約29m（東西方向）×約24m（南北方向） 高さ 約1m</td> </tr> <tr> <td rowspan="4">ネット（金網部）</td> <td>構成</td> <td>主ネット×2枚+補助ネット×1枚</td> </tr> <tr> <td>寸法</td> <td>線径：φ4mm 目合い寸法：主ネット50mm、補助ネット40mm</td> </tr> <tr> <td>主要材料</td> <td>硬鋼線材、亜鉛めっき鋼線</td> </tr> <tr> <td>数量</td> <td>5組</td> </tr> <tr> <td rowspan="3">フレーム</td> <td>寸法</td> <td>長さ×幅×高さ：約23m×4.3m×1m</td> </tr> <tr> <td>主要材料</td> <td>SM490A、SM400A、SS400</td> </tr> <tr> <td>仕様</td> <td>水平分分散型</td> </tr> <tr> <td rowspan="2">大梁</td> <td>寸法</td> <td>長さ×幅×高さ：約26m×1.5m×1.5m</td> </tr> <tr> <td>主要材料</td> <td>SM520B、SM490A</td> </tr> <tr> <td rowspan="2">ゴム支承</td> <td>仕様</td> <td>大梁用：4個（2組（2個/組）） フレーム用：10個（5組（2個/組））</td> </tr> <tr> <td>数量</td> <td>フレーム用：10個（5組（2個/組））</td> </tr> <tr> <td>可動支承</td> <td>数量</td> <td>フレーム用：10個（5組（2個/組））</td> </tr> <tr> <td>ブラケット</td> <td>材料</td> <td>SM490A</td> </tr> <tr> <td>防護板</td> <td>材料</td> <td>SM400A、SS400</td> </tr> <tr> <td>耐震クラス</td> <td>—</td> <td>C</td> </tr> </table> <p>3.2 設計条件</p> <p>3.2.1 荷重条件</p> <p>竜巻防護ネットは、設計竜巻による荷重とその他の荷重の組合せを適切に考慮した構造強度評価を実施し、各部材に発生する応力等が許容限界内にあることを確認する。構造強度評価の条件として、考慮する荷重の種類及び組合せを以下に示す。</p> <p>(1) 荷重の種類</p> <p>a. 常時作用する荷重</p> <p>常時作用する荷重としては、竜巻防護ネットの自重を考慮する。</p> <p>b. 運転時の状態で作用する荷重</p> <p>竜巻防護ネットは動的機能を持たない構造であり、通常運転時及び設計基準事故時に作用する荷重はない。</p> <p>c. 竜巻荷重</p> <p>設計竜巻により作用する荷重は「原子力発電所の竜巻影響評価ガイド」に示すとおり、「風圧力による荷重（W_w）」、「気圧差による荷重（W_p）」及び「設計飛来物による衝撃荷重（W_u）」を組み合わせた複合荷重として考慮する。複合荷重 W_{T1} 及び W_{T2} は、以下のとおり設定する。</p> $W_{T1} = W_p$ $W_{T2} = W_w + 0.5 \cdot W_p + W_u$ <p>ここで、設計飛来物による衝撃荷重としては、設計飛来物が衝突する場合の荷重を設定する。なお、気圧差による荷重（W_p）は、竜巻防護ネットの構造及び配置上考慮しない。</p> <p>(a) 風圧力による荷重（W_w）</p> <p>設計竜巻風速 100m/s の風圧力による荷重を考慮する。竜巻防護ネ</p>	総質量	約500ton	全体形状	約29m（東西方向）×約24m（南北方向） 高さ 約1m	ネット（金網部）	構成	主ネット×2枚+補助ネット×1枚	寸法	線径：φ4mm 目合い寸法：主ネット50mm、補助ネット40mm	主要材料	硬鋼線材、亜鉛めっき鋼線	数量	5組	フレーム	寸法	長さ×幅×高さ：約23m×4.3m×1m	主要材料	SM490A、SM400A、SS400	仕様	水平分分散型	大梁	寸法	長さ×幅×高さ：約26m×1.5m×1.5m	主要材料	SM520B、SM490A	ゴム支承	仕様	大梁用：4個（2組（2個/組）） フレーム用：10個（5組（2個/組））	数量	フレーム用：10個（5組（2個/組））	可動支承	数量	フレーム用：10個（5組（2個/組））	ブラケット	材料	SM490A	防護板	材料	SM400A、SS400	耐震クラス	—	C	<p style="text-align: center;">表1 竜巻防護ネットの仕様</p> <table border="1" style="width: 100%; border-collapse: collapse;"> <tr> <td rowspan="6">海水ポンプエリア上部</td> <td rowspan="3">ネット（金網部）</td> <td>構成</td> <td>主ネット×2枚+補助ネット×1枚</td> </tr> <tr> <td>寸法</td> <td>線径：φ4mm 目合い寸法：主ネット50mm、補助ネット40mm</td> </tr> <tr> <td>主要材料</td> <td>硬鋼線材、亜鉛めっき鋼線</td> </tr> <tr> <td rowspan="3">ネット（鋼製作）</td> <td>寸法</td> <td>約5.0×4.6m</td> </tr> <tr> <td>主要材料</td> <td>SS400</td> </tr> <tr> <td>数量</td> <td>4組</td> </tr> <tr> <td rowspan="3">架台</td> <td>数量</td> <td>2組（2開口に設置）</td> </tr> <tr> <td>寸法（高さ）</td> <td>約340mm</td> </tr> <tr> <td>主要材料</td> <td>SM490A、SM400A</td> </tr> <tr> <td rowspan="6">海水ストレージエリア上部</td> <td rowspan="3">ネット（金網部）</td> <td>構成</td> <td>主ネット×2枚+補助ネット×1枚</td> </tr> <tr> <td>寸法</td> <td>線径：φ4mm 目合い寸法：主ネット40mm、補助ネット40mm</td> </tr> <tr> <td>主要材料</td> <td>硬鋼線材、亜鉛めっき鋼線</td> </tr> <tr> <td rowspan="3">ネット（鋼製作）</td> <td>寸法</td> <td>約4.4m×2.6m</td> </tr> <tr> <td>主要材料</td> <td>SS400</td> </tr> <tr> <td>数量</td> <td>2組</td> </tr> <tr> <td rowspan="3">架台</td> <td>数量</td> <td>1組（1開口に設置）</td> </tr> <tr> <td>寸法（高さ）</td> <td>約635mm</td> </tr> <tr> <td>主要材料</td> <td>SM490A、SM400A</td> </tr> <tr> <td>すり抜け防止用鋼材</td> <td>主要材料</td> <td>SM400A</td> </tr> <tr> <td>ブラケット</td> <td>材料</td> <td>SM490A</td> </tr> <tr> <td>耐震クラス</td> <td>—</td> <td>C</td> </tr> </table> <p>3.2 設計条件</p> <p>3.2.1 荷重条件</p> <p>竜巻防護ネットは、設計竜巻による荷重とその他の荷重の組合せを適切に考慮した構造強度評価を実施し、各部材に発生する応力等が許容限界内にあることを確認する。構造強度評価の条件として、考慮する荷重の種類及び組合せを以下に示す。</p> <p>(1) 荷重の種類</p> <p>a. 常時作用する荷重</p> <p>常時作用する荷重としては、竜巻防護ネットの自重を考慮する。</p> <p>b. 運転時の状態で作用する荷重</p> <p>竜巻防護ネットは動的機能を持たない構造であり、通常運転時及び設計基準事故時に作用する荷重はない。</p> <p>c. 竜巻荷重</p> <p>設計竜巻により作用する荷重は「原子力発電所の竜巻影響評価ガイド」に示すとおり、「風圧力による荷重（W_w）」、「気圧差による荷重（W_p）」及び「設計飛来物による衝撃荷重（W_u）」を組み合わせた複合荷重として考慮する。複合荷重 W_{T1} 及び W_{T2} は、以下のとおり設定する。</p> $W_{T1} = W_p$ $W_{T2} = W_w + 0.5 \cdot W_p + W_u$ <p>ここで、設計飛来物による衝撃荷重としては、設計飛来物が衝突する場合の荷重を設定する。なお、気圧差による荷重（W_p）は、竜巻防護ネットの構造及び配置上考慮しない。</p> <p>(a) 風圧力による荷重（W_w）</p> <p>設計竜巻風速 100m/s の風圧力による荷重を考慮する。竜巻防護ネ</p>	海水ポンプエリア上部	ネット（金網部）	構成	主ネット×2枚+補助ネット×1枚	寸法	線径：φ4mm 目合い寸法：主ネット50mm、補助ネット40mm	主要材料	硬鋼線材、亜鉛めっき鋼線	ネット（鋼製作）	寸法	約5.0×4.6m	主要材料	SS400	数量	4組	架台	数量	2組（2開口に設置）	寸法（高さ）	約340mm	主要材料	SM490A、SM400A	海水ストレージエリア上部	ネット（金網部）	構成	主ネット×2枚+補助ネット×1枚	寸法	線径：φ4mm 目合い寸法：主ネット40mm、補助ネット40mm	主要材料	硬鋼線材、亜鉛めっき鋼線	ネット（鋼製作）	寸法	約4.4m×2.6m	主要材料	SS400	数量	2組	架台	数量	1組（1開口に設置）	寸法（高さ）	約635mm	主要材料	SM490A、SM400A	すり抜け防止用鋼材	主要材料	SM400A	ブラケット	材料	SM490A	耐震クラス	—	C	<p>【女川】</p> <p>防護ネットの設置方法の相違により仕様異なるため。</p>
総質量	約500ton																																																																																																	
全体形状	約29m（東西方向）×約24m（南北方向） 高さ 約1m																																																																																																	
ネット（金網部）	構成	主ネット×2枚+補助ネット×1枚																																																																																																
	寸法	線径：φ4mm 目合い寸法：主ネット50mm、補助ネット40mm																																																																																																
	主要材料	硬鋼線材、亜鉛めっき鋼線																																																																																																
	数量	5組																																																																																																
フレーム	寸法	長さ×幅×高さ：約23m×4.3m×1m																																																																																																
	主要材料	SM490A、SM400A、SS400																																																																																																
	仕様	水平分分散型																																																																																																
大梁	寸法	長さ×幅×高さ：約26m×1.5m×1.5m																																																																																																
	主要材料	SM520B、SM490A																																																																																																
ゴム支承	仕様	大梁用：4個（2組（2個/組）） フレーム用：10個（5組（2個/組））																																																																																																
	数量	フレーム用：10個（5組（2個/組））																																																																																																
可動支承	数量	フレーム用：10個（5組（2個/組））																																																																																																
ブラケット	材料	SM490A																																																																																																
防護板	材料	SM400A、SS400																																																																																																
耐震クラス	—	C																																																																																																
海水ポンプエリア上部	ネット（金網部）	構成	主ネット×2枚+補助ネット×1枚																																																																																															
		寸法	線径：φ4mm 目合い寸法：主ネット50mm、補助ネット40mm																																																																																															
		主要材料	硬鋼線材、亜鉛めっき鋼線																																																																																															
	ネット（鋼製作）	寸法	約5.0×4.6m																																																																																															
		主要材料	SS400																																																																																															
		数量	4組																																																																																															
架台	数量	2組（2開口に設置）																																																																																																
	寸法（高さ）	約340mm																																																																																																
	主要材料	SM490A、SM400A																																																																																																
海水ストレージエリア上部	ネット（金網部）	構成	主ネット×2枚+補助ネット×1枚																																																																																															
		寸法	線径：φ4mm 目合い寸法：主ネット40mm、補助ネット40mm																																																																																															
		主要材料	硬鋼線材、亜鉛めっき鋼線																																																																																															
	ネット（鋼製作）	寸法	約4.4m×2.6m																																																																																															
		主要材料	SS400																																																																																															
		数量	2組																																																																																															
架台	数量	1組（1開口に設置）																																																																																																
	寸法（高さ）	約635mm																																																																																																
	主要材料	SM490A、SM400A																																																																																																
すり抜け防止用鋼材	主要材料	SM400A																																																																																																
ブラケット	材料	SM490A																																																																																																
耐震クラス	—	C																																																																																																

赤字：設備、運用又は体制の相違（設計方針の相違）
 青字：記載箇所又は記載内容の相違（記載方針の相違）
 緑字：記載表現、設備名称の相違（実質的な相違なし）

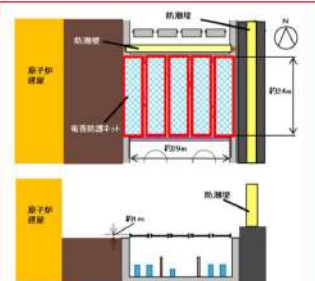
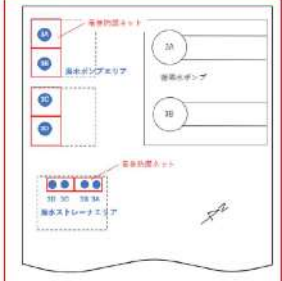
大飯発電所3/4号炉	女川原子力発電所2号炉	泊発電所3号炉	相違理由																																					
<p>ットの主たる形状はI型断面であることから、風圧力による荷重の算出に使用する風力係数は「建築物荷重指針・同解説」のI型断面部材を使用する。風圧力による荷重の算出にあたっては、風の方向によらず、I型断面部材に対し最も大きい風力係数であるC=2.1を使用し算出する。</p> <p>(b)設計飛来物による衝撃荷重 (W_u) 設計竜巻の最大風速 100m/s による設計飛来物の衝撃荷重は、砂利と比べ運動エネルギーが大きくなる鋼製材により算出する。竜巻防護ネットの形状は海水ポンプ室補機ポンプエリア（東西：約29m、南北：約24m）の上部全面に配置し、地上からの高さは約1mである。また、竜巻防護ネットの周囲は北側を防潮壁、東側を防潮堤で囲まれており、西側は約17mを隔てて、原子炉建屋が設置されている。</p> <p>竜巻防護ネットの配置状況を図4及び図5に示す。</p> <p>竜巻防護ネットの形状、周囲の状況を踏まえると、飛来物の衝突方向は鉛直方向が支配的であると考え。水平方向からの衝突は、鉛直方向からの衝突に比べて起こりにくいと考えるが、設計飛来物の最大水平速度が大きいことを踏まえて、原子炉建屋との間の水平方向（西側）からの衝突も考慮する。</p> <p>衝撃荷重は、鋼製材が衝突した場合の影響が大きくなる向きを考慮し、有限要素法により求める。飛来物の衝突速度を初速値として入力し、飛来物衝突評価により算出する。表2に設計飛来物の諸元を示す。</p>	<p>ットの主たる形状はI型断面であることから、風圧力による荷重の算出に使用する風力係数は「建築物荷重指針・同解説」のI型断面部材を使用する。風圧力による荷重の算出にあたっては、風の方向によらず、I型断面部材に対し最も大きい風力係数であるC=2.1を使用し算出する。</p> <p>(b)設計飛来物による衝撃荷重 (W_u) 設計竜巻の最大風速 100m/s による設計飛来物の衝撃荷重は、砂利、鋼製パイプと比べ運動エネルギーが大きくなる鋼製材により算出する。竜巻防護ネットの形状は海水ポンプエリア上部（約10m×約5.5m）及び海水ストレーナエリア上部（約10m×約2.6m）の全面に配置し、地上からの高さは約0.7mである。</p> <p>竜巻防護ネットの配置状況を図4及び図5に示す。</p> <p>竜巻防護ネットの形状、周囲の状況を踏まえて、飛来物の衝突方向は水平及び鉛直方向からの衝突を考慮する。</p> <p>衝撃荷重は、鋼製材が衝突した場合の影響が大きくなる向きを考慮し、有限要素法により求める。飛来物の衝突速度を初速値として入力し、飛来物衝突評価により算出する。表2に設計飛来物の諸元を示す。</p>	<p>ットの主たる形状はI型断面であることから、風圧力による荷重の算出に使用する風力係数は「建築物荷重指針・同解説」のI型断面部材を使用する。風圧力による荷重の算出にあたっては、風の方向によらず、I型断面部材に対し最も大きい風力係数であるC=2.1を使用し算出する。</p> <p>(b)設計飛来物による衝撃荷重 (W_u) 設計竜巻の最大風速 100m/s による設計飛来物の衝撃荷重は、砂利、鋼製パイプと比べ運動エネルギーが大きくなる鋼製材により算出する。竜巻防護ネットの形状は海水ポンプエリア上部（約10m×約5.5m）及び海水ストレーナエリア上部（約10m×約2.6m）の全面に配置し、地上からの高さは約0.7mである。</p> <p>竜巻防護ネットの配置状況を図4及び図5に示す。</p> <p>竜巻防護ネットの形状、周囲の状況を踏まえて、飛来物の衝突方向は水平及び鉛直方向からの衝突を考慮する。</p> <p>衝撃荷重は、鋼製材が衝突した場合の影響が大きくなる向きを考慮し、有限要素法により求める。飛来物の衝突速度を初速値として入力し、飛来物衝突評価により算出する。表2に設計飛来物の諸元を示す。</p>	<p>相違理由</p> <p>【女川】 竜巻防護ネット設置箇所、寸法の相違</p> <p>【女川】 記載表現の相違</p> <p>【女川】 飛来物の想定方向の相違</p> <p>泊においては竜巻防護ネットを設置する周辺に設計飛来物の侵入ルートを防ぐことのできる構造物がないためすべての方向からの衝突を考慮しているため。</p> <p>【女川】 設計飛来物の相違</p> <p>泊においては、鋼製パイプが新燃料ビットへの衝突する可能性があることから設計飛来物が追加している</p> <p>【女川】 防護ネットの設置方法の相違</p>																																					
<p>表2 設計飛来物の諸元</p> <table border="1"> <thead> <tr> <th rowspan="2">設計飛来物</th> <th colspan="2">仕様</th> <th rowspan="2">最大水平速度 (m/s)</th> <th rowspan="2">最大鉛直速度 (m/s)</th> </tr> <tr> <th>サイズ (m)</th> <th>質量 (kg)</th> </tr> </thead> <tbody> <tr> <td>鋼製材</td> <td>縦×横×高さ 4.2×0.3×0.2</td> <td>135</td> <td>46.6</td> <td>16.7</td> </tr> <tr> <td>砂利</td> <td>縦×横×高さ 0.04×0.04×0.04</td> <td>0.2</td> <td>59.3</td> <td>22.6</td> </tr> </tbody> </table>	設計飛来物	仕様		最大水平速度 (m/s)	最大鉛直速度 (m/s)	サイズ (m)	質量 (kg)	鋼製材	縦×横×高さ 4.2×0.3×0.2	135	46.6	16.7	砂利	縦×横×高さ 0.04×0.04×0.04	0.2	59.3	22.6	<p>表2 設計飛来物の諸元</p> <table border="1"> <thead> <tr> <th rowspan="2">設計飛来物</th> <th colspan="2">仕様</th> <th rowspan="2">最大水平速度 (m/s)</th> <th rowspan="2">最大鉛直速度 (m/s)</th> </tr> <tr> <th>サイズ (m)</th> <th>質量 (kg)</th> </tr> </thead> <tbody> <tr> <td>鋼製材</td> <td>縦×横×高さ 4.2×0.3×0.2</td> <td>135</td> <td>57</td> <td>38</td> </tr> <tr> <td>鋼製パイプ</td> <td>長さ×直径 2×0.05</td> <td>8.4</td> <td>49</td> <td>33</td> </tr> <tr> <td>砂利</td> <td>縦×横×高さ 0.04×0.04×0.04</td> <td>0.18</td> <td>62</td> <td>42</td> </tr> </tbody> </table>	設計飛来物	仕様		最大水平速度 (m/s)	最大鉛直速度 (m/s)	サイズ (m)	質量 (kg)	鋼製材	縦×横×高さ 4.2×0.3×0.2	135	57	38	鋼製パイプ	長さ×直径 2×0.05	8.4	49	33	砂利	縦×横×高さ 0.04×0.04×0.04	0.18	62	42
設計飛来物		仕様				最大水平速度 (m/s)	最大鉛直速度 (m/s)																																	
	サイズ (m)	質量 (kg)																																						
鋼製材	縦×横×高さ 4.2×0.3×0.2	135	46.6	16.7																																				
砂利	縦×横×高さ 0.04×0.04×0.04	0.2	59.3	22.6																																				
設計飛来物	仕様		最大水平速度 (m/s)	最大鉛直速度 (m/s)																																				
	サイズ (m)	質量 (kg)																																						
鋼製材	縦×横×高さ 4.2×0.3×0.2	135	57	38																																				
鋼製パイプ	長さ×直径 2×0.05	8.4	49	33																																				
砂利	縦×横×高さ 0.04×0.04×0.04	0.18	62	42																																				
 <p>図4 竜巻防護ネットの配置（平面図）</p>	 <p>図4 竜巻防護ネットの配置（平面図）</p>																																							

赤字：設備、運用又は体制の相違（設計方針の相違）
 青字：記載箇所又は記載内容の相違（記載方針の相違）
 緑字：記載表現、設備名称の相違（実質的な相違なし）

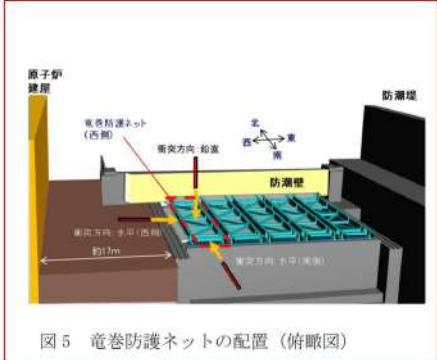
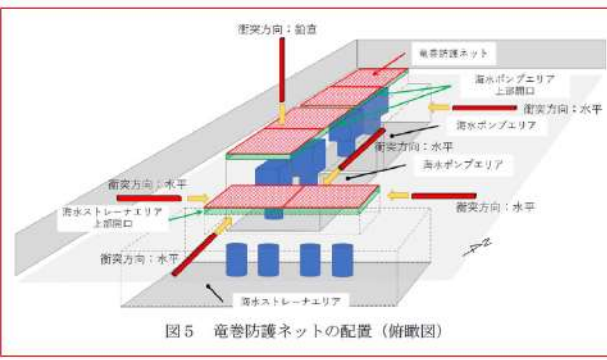
大飯発電所3/4号炉	女川原子力発電所2号炉	泊発電所3号炉	相違理由																																				
	 <p>図5 竜巻防護ネットの配置（俯瞰図）</p> <p>(2) 荷重の組合せ 「別添資料1 3.3.2 設計竜巻荷重と組合せる荷重の設定」を踏まえ、荷重の組合せを表3に示す。</p> <p>表3 竜巻防護ネットにおいて組合せを考慮する荷重</p> <table border="1" data-bbox="721 699 1310 833"> <thead> <tr> <th colspan="5">考慮する荷重</th> </tr> <tr> <th rowspan="2">常時作用する荷重</th> <th rowspan="2">運転時の状態で作用する荷重</th> <th colspan="3">竜巻荷重</th> </tr> <tr> <th>風圧力</th> <th>気圧差</th> <th>設計飛来物による衝撃荷重</th> </tr> </thead> <tbody> <tr> <td>自重</td> <td>—</td> <td>○</td> <td>—</td> <td>○</td> </tr> </tbody> </table> <p>○：考慮する，—：考慮不要</p> <p>3.3 竜巻防護ネットの設計方針 3.3.1 竜巻防護ネットの設計方針 「2. 竜巻防護ネットに対する要求事項」を踏まえて、設置許可基準規則の各条文（第4条，第6条）に対する竜巻防護ネットの設計方針を表4のとおり整理した。</p>	考慮する荷重					常時作用する荷重	運転時の状態で作用する荷重	竜巻荷重			風圧力	気圧差	設計飛来物による衝撃荷重	自重	—	○	—	○	 <p>図5 竜巻防護ネットの配置（俯瞰図）</p> <p>(2) 荷重の組合せ 「別添資料1 3.3.2 設計竜巻荷重と組合せる荷重の設定」を踏まえ、荷重の組合せを表3に示す。</p> <p>表3 竜巻防護ネットにおいて組合せを考慮する荷重</p> <table border="1" data-bbox="1348 699 1944 833"> <thead> <tr> <th colspan="5">考慮する荷重</th> </tr> <tr> <th rowspan="2">常時作用する荷重</th> <th rowspan="2">運転時の状態で作用する荷重</th> <th colspan="3">竜巻荷重</th> </tr> <tr> <th>風圧力</th> <th>気圧差</th> <th>設計飛来物による衝撃荷重</th> </tr> </thead> <tbody> <tr> <td>自重</td> <td>—</td> <td>○</td> <td>—</td> <td>○</td> </tr> </tbody> </table> <p>○：考慮する，—：考慮不要</p> <p>3.3 竜巻防護ネットの設計方針 3.3.1 竜巻防護ネットの設計方針 「2. 竜巻防護ネットに対する要求事項」を踏まえて、設置許可基準規則の各条文（第4条，第6条）に対する竜巻防護ネットの設計方針を表4のとおり整理した。</p>	考慮する荷重					常時作用する荷重	運転時の状態で作用する荷重	竜巻荷重			風圧力	気圧差	設計飛来物による衝撃荷重	自重	—	○	—	○	<p>【女川】 防護ネットの設置環境の違いによる構造の相違</p>
考慮する荷重																																							
常時作用する荷重	運転時の状態で作用する荷重	竜巻荷重																																					
		風圧力	気圧差	設計飛来物による衝撃荷重																																			
自重	—	○	—	○																																			
考慮する荷重																																							
常時作用する荷重	運転時の状態で作用する荷重	竜巻荷重																																					
		風圧力	気圧差	設計飛来物による衝撃荷重																																			
自重	—	○	—	○																																			

赤字：設備、運用又は体制の相違（設計方針の相違）
 青字：記載箇所又は記載内容の相違（記載方針の相違）
 緑字：記載表現、設備名称の相違（実質的な相違なし）

大飯発電所3/4号炉	女川原子力発電所2号炉	泊発電所3号炉	相違理由																		
	<p style="text-align: center;">表4 竜巻防護ネットの設計方針</p> <table border="1" style="width: 100%;"> <thead> <tr> <th style="width: 15%;">設置許可基準規則</th> <th style="width: 60%;">竜巻防護ネットの設計方針</th> <th style="width: 25%;">備考</th> </tr> </thead> <tbody> <tr> <td>第4条 地震による損傷の防止</td> <td>上位クラスである非常用海水ポンプ等に対し、地震時において竜巻防護ネットの損傷等により波及的影響を及ぼさないよう、基準地震動Ssに対して十分な構造強度を有すること。</td> <td>設置許可基準規則第4条に対する適合状況説明資料『設計基準対象施設について（第4条 地震による損傷の防止）』で説明</td> </tr> <tr> <td>第6条 外部からの衝撃による損傷の防止（竜巻）</td> <td>竜巻防護ネットは、竜巻時及び竜巻通過後において、設計竜巻荷重及びその他考慮すべき荷重に対し、内包する非常用海水ポンプ等が安全機能を損なわないよう、設計飛来物が非常用海水ポンプ等に衝突することを防止可能な設計とする。また、竜巻防護ネットは、その他考えられる自然現象に対して、非常用海水ポンプ等に波及的影響を及ぼさない設計とする。</td> <td></td> </tr> </tbody> </table> <p>竜巻防護ネットは、上記設計方針及び「3.1.2 構造概要」で示した構造と、「3.2.1 荷重条件」で設定した荷重を踏まえて設計する。 竜巻防護ネットの設計フローを図6に示す。 竜巻防護ネットの構造の特徴である、ゴム支承、可動支承の採用による設計上考慮すべき事項については、適切に設計へ反映する。</p>	設置許可基準規則	竜巻防護ネットの設計方針	備考	第4条 地震による損傷の防止	上位クラスである非常用海水ポンプ等に対し、地震時において竜巻防護ネットの損傷等により波及的影響を及ぼさないよう、基準地震動Ssに対して十分な構造強度を有すること。	設置許可基準規則第4条に対する適合状況説明資料『設計基準対象施設について（第4条 地震による損傷の防止）』で説明	第6条 外部からの衝撃による損傷の防止（竜巻）	竜巻防護ネットは、竜巻時及び竜巻通過後において、設計竜巻荷重及びその他考慮すべき荷重に対し、内包する非常用海水ポンプ等が安全機能を損なわないよう、設計飛来物が非常用海水ポンプ等に衝突することを防止可能な設計とする。また、竜巻防護ネットは、その他考えられる自然現象に対して、非常用海水ポンプ等に波及的影響を及ぼさない設計とする。		<p style="text-align: center;">表4 竜巻防護ネットの設計方針</p> <table border="1" style="width: 100%;"> <thead> <tr> <th style="width: 15%;">設置許可基準規則</th> <th style="width: 60%;">竜巻防護ネットの設計方針</th> <th style="width: 25%;">備考</th> </tr> </thead> <tbody> <tr> <td>第4条 地震による損傷の防止</td> <td>上位クラスである原子炉補機冷却海水ポンプ等に対し、地震時において竜巻防護ネットの損傷等により波及的影響を及ぼさないよう、基準地震動Ssに対して十分な構造強度を有すること。</td> <td>設置許可基準規則第4条に対する適合状況説明資料『設計基準対象施設について（第4条 地震による損傷の防止）』で説明</td> </tr> <tr> <td>第6条 外部からの衝撃による損傷の防止（竜巻）</td> <td>竜巻防護ネットは、竜巻時及び竜巻通過後において、設計竜巻荷重及びその他考慮すべき荷重に対し、内包する原子炉補機冷却海水ポンプ等が安全機能を損なわないよう、設計飛来物が原子炉補機冷却海水ポンプ等に衝突することを防止可能な設計とする。また、竜巻防護ネットは、その他考えられる自然現象に対して、原子炉補機冷却海水ポンプ等に波及的影響を及ぼさない設計とする。</td> <td></td> </tr> </tbody> </table> <p>竜巻防護ネットは、上記設計方針及び「3.1.2 構造概要」で示した構造と、「3.2.1 荷重条件」で設定した荷重を踏まえて設計する。 竜巻防護ネットの設計フローを図6に示す。</p>	設置許可基準規則	竜巻防護ネットの設計方針	備考	第4条 地震による損傷の防止	上位クラスである原子炉補機冷却海水ポンプ等に対し、地震時において竜巻防護ネットの損傷等により波及的影響を及ぼさないよう、基準地震動Ssに対して十分な構造強度を有すること。	設置許可基準規則第4条に対する適合状況説明資料『設計基準対象施設について（第4条 地震による損傷の防止）』で説明	第6条 外部からの衝撃による損傷の防止（竜巻）	竜巻防護ネットは、竜巻時及び竜巻通過後において、設計竜巻荷重及びその他考慮すべき荷重に対し、内包する原子炉補機冷却海水ポンプ等が安全機能を損なわないよう、設計飛来物が原子炉補機冷却海水ポンプ等に衝突することを防止可能な設計とする。また、竜巻防護ネットは、その他考えられる自然現象に対して、原子炉補機冷却海水ポンプ等に波及的影響を及ぼさない設計とする。		<p>【女川】 竜巻防護ネットで防護する対象機器の相違</p> <p>【女川】 ・竜巻防護設備の構造の相違。 ・女川は竜巻防護ネットを設置する海水ポンプエリアの壁が薄く支持機能に期待できないため、可動支承、ゴム支承を採用して地震により生じる応力を低減・分散させる構造として、ネットの支持機能を確保している。 ・泊においては、女川と異なり竜巻防護ネットは強固な建屋床面、ブラケットを介してピット壁面に設置できる環境であることから、女川の竜巻防護ネットの可動支承のような可動式の機構を持たせる必要はない。 ・以上の理由から、泊の竜巻防護ネットは、先行プラント（大飯、高浜）と同様の竜巻防護ネットの構造を採用</p>
設置許可基準規則	竜巻防護ネットの設計方針	備考																			
第4条 地震による損傷の防止	上位クラスである非常用海水ポンプ等に対し、地震時において竜巻防護ネットの損傷等により波及的影響を及ぼさないよう、基準地震動Ssに対して十分な構造強度を有すること。	設置許可基準規則第4条に対する適合状況説明資料『設計基準対象施設について（第4条 地震による損傷の防止）』で説明																			
第6条 外部からの衝撃による損傷の防止（竜巻）	竜巻防護ネットは、竜巻時及び竜巻通過後において、設計竜巻荷重及びその他考慮すべき荷重に対し、内包する非常用海水ポンプ等が安全機能を損なわないよう、設計飛来物が非常用海水ポンプ等に衝突することを防止可能な設計とする。また、竜巻防護ネットは、その他考えられる自然現象に対して、非常用海水ポンプ等に波及的影響を及ぼさない設計とする。																				
設置許可基準規則	竜巻防護ネットの設計方針	備考																			
第4条 地震による損傷の防止	上位クラスである原子炉補機冷却海水ポンプ等に対し、地震時において竜巻防護ネットの損傷等により波及的影響を及ぼさないよう、基準地震動Ssに対して十分な構造強度を有すること。	設置許可基準規則第4条に対する適合状況説明資料『設計基準対象施設について（第4条 地震による損傷の防止）』で説明																			
第6条 外部からの衝撃による損傷の防止（竜巻）	竜巻防護ネットは、竜巻時及び竜巻通過後において、設計竜巻荷重及びその他考慮すべき荷重に対し、内包する原子炉補機冷却海水ポンプ等が安全機能を損なわないよう、設計飛来物が原子炉補機冷却海水ポンプ等に衝突することを防止可能な設計とする。また、竜巻防護ネットは、その他考えられる自然現象に対して、原子炉補機冷却海水ポンプ等に波及的影響を及ぼさない設計とする。																				

赤字：設備、運用又は体制の相違（設計方針の相違）
 青字：記載箇所又は記載内容の相違（記載方針の相違）
 緑字：記載表現、設備名称の相違（実質的な相違なし）

大飯発電所3/4号炉	女川原子力発電所2号炉	泊発電所3号炉	相違理由
	<p>図6 竜巻防護ネットの設計フロー</p> <p>→ 構成要素の評価条件 → 異なる構成要素への評価結果アウトプット 竜巻防護ネットの構造設計の特徴 ※1 ゴム支承、可動支承による設計への反映事項</p>	<p>図6 竜巻防護ネットの設計フロー</p>	<p>しており、架構に直接、竜巻防護ネットを設置する構造としている。</p> <p>【女川】</p> <ul style="list-style-type: none"> ・竜巻防護設備の構造の相違。 ・女川は竜巻防護ネットを設置する海水ポンプエリアの壁が薄く支持機能に期待できないため、可動支承、ゴム支承を採用して地震により生じる応力を低減・分散させる構造として、ネットの支持機能を確保している。 ・泊においては、女川と異なり竜巻防護ネットは強固な建屋床面、ブラケットを介してピット壁面に設置できる環境であることから、女川の竜巻防護ネットの可動支承のような可動式の機構を持たせる必要はない。 ・以上の理由から、泊の竜巻防護ネットは、先行プラント（大飯、高浜）と同様の竜巻防護ネットの構造を採用しており、架構に直接、竜巻防護ネットを設置する構造としている。 ・泊においては、可動構造ではないことから、荷重の伝わる上流から順に評価・設計を行うことで成立性が確認できることから、設計フローに相違が生じている。

赤字：設備、運用又は体制の相違（設計方針の相違）
 青字：記載箇所又は記載内容の相違（記載方針の相違）
 緑字：記載表現、設備名称の相違（実質的な相違なし）

大飯発電所3/4号炉

女川原子力発電所2号炉

泊発電所3号炉

相違理由

3.3.2 竜巻防護ネットに対する各条文の設計方針に対応する各部位の役割
 竜巻防護ネットに対する設置許可基準規則の各条文（4条及び6条）の設計方針に対する役割を表5のとおり整理した。

部位の名称	各部位の役割	
	地震（4条）	竜巻（6条）
ネット（金網部）	—	設計飛来物の非常用海水ポンプ等への到達を防止する
防護板	—	—
フレーム	ネット（金網部）及び防護板を支持する	ネット（金網部）及び防護板を支持する 設計飛来物の非常用海水ポンプ等への到達を防止する
大梁	フレーム及び可動支承を支持する	フレーム及び可動支承を支持する
ブラケット	大梁を支持する	大梁を支持する
フレームゴム支承	フレームを支持する（ゴム支承のアイソレート機能 [※] により竜巻防護ネットの固有値をやや長周期化することで、海水ポンプ室への反力を低減）	フレームを支持する（ゴム支承のアイソレート機能 [※] を期待しない）
大梁ゴム支承	大梁を支持する（ゴム支承のアイソレート機能 [※] により竜巻防護ネットの固有値をやや長周期化することで、海水ポンプ室への反力を低減）	大梁を支持する（ゴム支承のアイソレート機能 [※] を期待しない）
可動支承	フレームを支持する	フレームを支持する
ストッパー	—	フレームを支持する

※：水平方向に上部構造をよからく支持することで、固有周期を長くし、地震力を低減すること（参考文献：道路橋支保脚規）

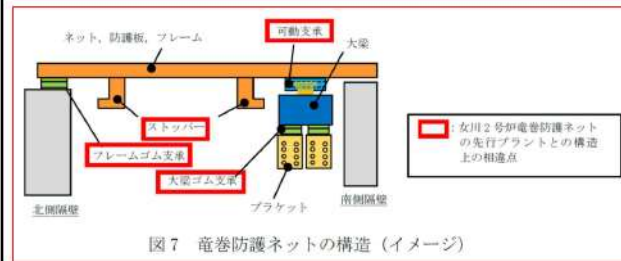

3.3.2 竜巻防護ネットに対する各条文の設計方針に対応する各部位の役割
 竜巻防護ネットに対する設置許可基準規則の各条文（4条及び6条）の設計方針に対する役割を表5のとおり整理した。

部位の名称	各部位の役割	
	地震（4条）	竜巻（6条）
ネット（金網部）	—	設計飛来物の原子炉補機冷却海水ポンプ等への到達を防止する
ネット（鋼製枠）		—
すり抜け防止用鋼材		—
支持部材	架台	ネット（金網部）を支持する 設計飛来物の原子炉補機冷却海水ポンプ等への到達を防止する
	ブラケット	架台を支持する

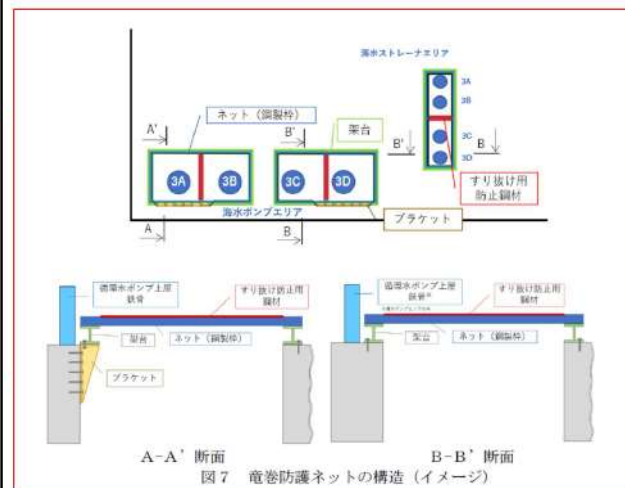

【女川】
 ・竜巻防護設備の構造の相違。
 ・女川は竜巻防護ネットを設置する海水ポンプエリアの壁が薄く支持機能に期待できないため、可動支承、ゴム支承を採用して地震により生じる応力を低減・分散させる構造として、ネットの支持機能を確保している。
 ・泊においては、女川と異なり竜巻防護ネットは強固な建屋床面、ブラケットを介してピット壁面に設置できる環境であることから、女川の竜巻防護ネットの可動支承のような可動式の機構を持たせる必要はない。
 ・以上の理由から、泊の竜巻防護ネットは、先行プラント（大飯、高浜）と同様の竜巻防護ネットの構造を採用しており、架構に直接、竜巻防護ネットを設置する構造としている。

赤字：設備、運用又は体制の相違（設計方針の相違）
 青字：記載箇所又は記載内容の相違（記載方針の相違）
 緑字：記載表現、設備名称の相違（実質的な相違なし）

大飯発電所3/4号炉	女川原子力発電所2号炉	泊発電所3号炉	相違理由																																										
	<p>3.3.3 竜巻防護ネット各部位の設計方針</p> <p>各部位の役割を踏まえ、竜巻防護ネットの各部位に対する設計方針及び評価項目について表6に整理した。なお、先行プラントとの設計方針の比較について別紙1に整理する。</p> <table border="1" data-bbox="712 587 1326 1168"> <caption>表6 竜巻防護ネット各部位に対する設計方針</caption> <thead> <tr> <th>部位の名称</th> <th>設計方針</th> <th>評価項目</th> </tr> </thead> <tbody> <tr> <td rowspan="3">ネット（金網部）</td> <td rowspan="3">ネットは、設計竜巻の風圧力による荷重、飛来物による衝撃荷重及びその他の荷重に対し、飛来物が非常用海水ポンプ等へ衝突することを防止するために、主要な部材が破断せず、たわみが生じても、非常用海水ポンプ等の機能喪失に至る可能性がある飛来物が非常用海水ポンプ等と衝突しないよう捕捉できる設計とする。</td> <td>吸収エネルギー評価</td> </tr> <tr> <td>破断評価</td> </tr> <tr> <td>たわみ評価</td> </tr> <tr> <td>防護板</td> <td>防護板は、設計竜巻の風圧力による荷重、飛来物による衝撃荷重及びその他の荷重に対し、飛来物が非常用海水ポンプ等へ衝突することを防止するために、飛来物が防護板を貫通せず、非常用海水ポンプ等に波及的影響を与えない設計とする。</td> <td>貫通評価</td> </tr> <tr> <td rowspan="6">支持部材</td> <td>フレーム</td> <td rowspan="6">支持部材は設計竜巻の風圧力による荷重、飛来物による衝撃荷重及びその他の荷重に対し、飛来物が非常用海水ポンプ等へ衝突することを防止するために、飛来物が支持部材を構成する主要な構造部材を貫通せず、上載するネット及び防護板を支持する機能を維持可能な構造強度を有し、非常用海水ポンプ等に波及的影響を与えないために、支持部材を構成する部材自体の転倒及び脱落を生じない設計とする。</td> <td rowspan="6">支持機能評価</td> </tr> <tr> <td>大梁</td> </tr> <tr> <td>ブラケット</td> </tr> <tr> <td>フレームゴム支承</td> </tr> <tr> <td>大梁ゴム支承</td> </tr> <tr> <td>可動支承</td> </tr> <tr> <td>ストッパー</td> </tr> </tbody> </table>	部位の名称	設計方針	評価項目	ネット（金網部）	ネットは、設計竜巻の風圧力による荷重、飛来物による衝撃荷重及びその他の荷重に対し、飛来物が非常用海水ポンプ等へ衝突することを防止するために、主要な部材が破断せず、たわみが生じても、非常用海水ポンプ等の機能喪失に至る可能性がある飛来物が非常用海水ポンプ等と衝突しないよう捕捉できる設計とする。	吸収エネルギー評価	破断評価	たわみ評価	防護板	防護板は、設計竜巻の風圧力による荷重、飛来物による衝撃荷重及びその他の荷重に対し、飛来物が非常用海水ポンプ等へ衝突することを防止するために、飛来物が防護板を貫通せず、非常用海水ポンプ等に波及的影響を与えない設計とする。	貫通評価	支持部材	フレーム	支持部材は設計竜巻の風圧力による荷重、飛来物による衝撃荷重及びその他の荷重に対し、飛来物が非常用海水ポンプ等へ衝突することを防止するために、飛来物が支持部材を構成する主要な構造部材を貫通せず、上載するネット及び防護板を支持する機能を維持可能な構造強度を有し、非常用海水ポンプ等に波及的影響を与えないために、支持部材を構成する部材自体の転倒及び脱落を生じない設計とする。	支持機能評価	大梁	ブラケット	フレームゴム支承	大梁ゴム支承	可動支承	ストッパー	<p>3.3.3 竜巻防護ネット各部位の設計方針</p> <p>各部位の役割を踏まえ、竜巻防護ネットの各部位に対する設計方針及び評価項目について表6に整理した。</p> <table border="1" data-bbox="1344 587 1957 1401"> <caption>表6 竜巻防護ネット各部位に対する設計方針</caption> <thead> <tr> <th>部位の名称</th> <th>設計方針</th> <th>評価項目</th> </tr> </thead> <tbody> <tr> <td rowspan="3">ネット（金網部）</td> <td rowspan="3">金網部は、設計竜巻の風圧力による荷重、飛来物による衝撃荷重及びその他の荷重に対し、飛来物が原子炉補機冷却海水ポンプ等へ衝突することを防止するために、主要な部材が破断せず、たわみが生じても、原子炉補機冷却海水ポンプ等の機能喪失に至る可能性がある飛来物が原子炉補機冷却海水ポンプ等と衝突しないよう捕捉できる設計とする。</td> <td>吸収エネルギー評価</td> </tr> <tr> <td>破断評価</td> </tr> <tr> <td>たわみ評価</td> </tr> <tr> <td>ネット（鋼製枠）</td> <td>鋼製枠は原子炉補機冷却海水ポンプ等へ衝突することを防止するために、ネット（金網部）及びすり抜け防止鋼材を支持する機能を維持可能な構造強度を有し、原子炉補機冷却海水ポンプ等に波及的影響を与えないために、設計飛来物の貫通及び脱落を生じない設計とする。</td> <td>貫通評価 支持機能評価</td> </tr> <tr> <td>すり抜け防止用鋼材</td> <td>鋼材は、設計竜巻の風圧力による荷重、飛来物による衝撃荷重及びその他の荷重に対し、飛来物が原子炉補機冷却海水ポンプ等へ衝突することを防止するために、飛来物が防護板を貫通せず、原子炉補機冷却海水ポンプ等に波及的影響を与えない設計とする。</td> <td>貫通評価</td> </tr> <tr> <td rowspan="2">支持部材</td> <td>架台</td> <td>架台は原子炉補機冷却海水ポンプ等へ衝突することを防止するために、ネット及びすり抜け防止鋼材を支持する機能を維持可能な構造強度を有し、原子炉補機冷却海水ポンプ等に波及的影響を与えないために、転倒及び脱落を生じない設計とする。</td> <td>貫通評価 支持機能評価</td> </tr> <tr> <td>ブラケット</td> <td>ブラケットは架台を支持する機能を維持可能な構造強度を有し、原子炉補機冷却海水ポンプに波及的影響を与えないために、脱落を生じない設計とする。</td> <td>支持機能評価</td> </tr> </tbody> </table>	部位の名称	設計方針	評価項目	ネット（金網部）	金網部は、設計竜巻の風圧力による荷重、飛来物による衝撃荷重及びその他の荷重に対し、飛来物が原子炉補機冷却海水ポンプ等へ衝突することを防止するために、主要な部材が破断せず、たわみが生じても、原子炉補機冷却海水ポンプ等の機能喪失に至る可能性がある飛来物が原子炉補機冷却海水ポンプ等と衝突しないよう捕捉できる設計とする。	吸収エネルギー評価	破断評価	たわみ評価	ネット（鋼製枠）	鋼製枠は原子炉補機冷却海水ポンプ等へ衝突することを防止するために、ネット（金網部）及びすり抜け防止鋼材を支持する機能を維持可能な構造強度を有し、原子炉補機冷却海水ポンプ等に波及的影響を与えないために、設計飛来物の貫通及び脱落を生じない設計とする。	貫通評価 支持機能評価	すり抜け防止用鋼材	鋼材は、設計竜巻の風圧力による荷重、飛来物による衝撃荷重及びその他の荷重に対し、飛来物が原子炉補機冷却海水ポンプ等へ衝突することを防止するために、飛来物が防護板を貫通せず、原子炉補機冷却海水ポンプ等に波及的影響を与えない設計とする。	貫通評価	支持部材	架台	架台は原子炉補機冷却海水ポンプ等へ衝突することを防止するために、ネット及びすり抜け防止鋼材を支持する機能を維持可能な構造強度を有し、原子炉補機冷却海水ポンプ等に波及的影響を与えないために、転倒及び脱落を生じない設計とする。	貫通評価 支持機能評価	ブラケット	ブラケットは架台を支持する機能を維持可能な構造強度を有し、原子炉補機冷却海水ポンプに波及的影響を与えないために、脱落を生じない設計とする。	支持機能評価	<p>相違理由</p> <p>【女川】 女川における別紙1は、先行プラントで実績のなかったゴム支承及び可動支承を採用しているために、設計方針の比較をしたものと考えている。泊においては、ゴム支承及び可動支承を採用していないため、設計方針の比較は不要のため作成しない。</p> <p>【女川】 ・竜巻防護設備の構造の相違。 ・女川は竜巻防護ネットを設置する海水ポンプエリアの壁が薄く支持機能に期待できないため、可動支承、ゴム支承を採用して地震により生じる応力を低減・分散させる構造として、ネットの支持機能を確保している。 ・泊においては、女川と異なり竜巻防護ネットは強固な建屋床面、ブラケットを介してピット壁面に設置できる環境であることから、女川の竜巻防護ネットの可動支承のような可動式の機構を持たせる必要はない。 ・以上の理由から、泊の竜巻防護ネットは、先行プラント（大飯、高浜）と同様の竜巻防護ネットの構造を採用しており、架構に直接、竜巻防護ネットを設置する構造としている。</p>
部位の名称	設計方針	評価項目																																											
ネット（金網部）	ネットは、設計竜巻の風圧力による荷重、飛来物による衝撃荷重及びその他の荷重に対し、飛来物が非常用海水ポンプ等へ衝突することを防止するために、主要な部材が破断せず、たわみが生じても、非常用海水ポンプ等の機能喪失に至る可能性がある飛来物が非常用海水ポンプ等と衝突しないよう捕捉できる設計とする。	吸収エネルギー評価																																											
		破断評価																																											
		たわみ評価																																											
防護板	防護板は、設計竜巻の風圧力による荷重、飛来物による衝撃荷重及びその他の荷重に対し、飛来物が非常用海水ポンプ等へ衝突することを防止するために、飛来物が防護板を貫通せず、非常用海水ポンプ等に波及的影響を与えない設計とする。	貫通評価																																											
支持部材	フレーム	支持部材は設計竜巻の風圧力による荷重、飛来物による衝撃荷重及びその他の荷重に対し、飛来物が非常用海水ポンプ等へ衝突することを防止するために、飛来物が支持部材を構成する主要な構造部材を貫通せず、上載するネット及び防護板を支持する機能を維持可能な構造強度を有し、非常用海水ポンプ等に波及的影響を与えないために、支持部材を構成する部材自体の転倒及び脱落を生じない設計とする。	支持機能評価																																										
	大梁																																												
	ブラケット																																												
	フレームゴム支承																																												
	大梁ゴム支承																																												
	可動支承																																												
ストッパー																																													
部位の名称	設計方針	評価項目																																											
ネット（金網部）	金網部は、設計竜巻の風圧力による荷重、飛来物による衝撃荷重及びその他の荷重に対し、飛来物が原子炉補機冷却海水ポンプ等へ衝突することを防止するために、主要な部材が破断せず、たわみが生じても、原子炉補機冷却海水ポンプ等の機能喪失に至る可能性がある飛来物が原子炉補機冷却海水ポンプ等と衝突しないよう捕捉できる設計とする。	吸収エネルギー評価																																											
		破断評価																																											
		たわみ評価																																											
ネット（鋼製枠）	鋼製枠は原子炉補機冷却海水ポンプ等へ衝突することを防止するために、ネット（金網部）及びすり抜け防止鋼材を支持する機能を維持可能な構造強度を有し、原子炉補機冷却海水ポンプ等に波及的影響を与えないために、設計飛来物の貫通及び脱落を生じない設計とする。	貫通評価 支持機能評価																																											
すり抜け防止用鋼材	鋼材は、設計竜巻の風圧力による荷重、飛来物による衝撃荷重及びその他の荷重に対し、飛来物が原子炉補機冷却海水ポンプ等へ衝突することを防止するために、飛来物が防護板を貫通せず、原子炉補機冷却海水ポンプ等に波及的影響を与えない設計とする。	貫通評価																																											
支持部材	架台	架台は原子炉補機冷却海水ポンプ等へ衝突することを防止するために、ネット及びすり抜け防止鋼材を支持する機能を維持可能な構造強度を有し、原子炉補機冷却海水ポンプ等に波及的影響を与えないために、転倒及び脱落を生じない設計とする。	貫通評価 支持機能評価																																										
	ブラケット	ブラケットは架台を支持する機能を維持可能な構造強度を有し、原子炉補機冷却海水ポンプに波及的影響を与えないために、脱落を生じない設計とする。	支持機能評価																																										

赤字：設備、運用又は体制の相違（設計方針の相違）
 青字：記載箇所又は記載内容の相違（記載方針の相違）
 緑字：記載表現、設備名称の相違（実質的な相違なし）

大飯発電所3/4号炉	女川原子力発電所2号炉	泊発電所3号炉	相違理由																											
<p>3.4 ネット（金網部）の構造設計</p> <p>3.4.1 基本設計</p> <p>設計飛来物が衝突した際に局部的に生じる衝撃荷重に耐え、変形することにより設計飛来物の持つ運動エネルギーを吸収し、非常用海水ポンプ等への衝突を防止する。</p> <p>竜巻防護ネットの基本仕様は、電力中央研究所にて評価、試験を行い、検証されたものを適用し、防護性能の評価は以下のとおり実施する。</p> <p>設計飛来物の衝突位置の影響として、中央位置からずれたオフセット位置に衝突する場合の影響を考慮する。</p> <ul style="list-style-type: none"> ・ネットの吸収エネルギー評価 ・ネットの破断評価 ・ネットのたわみ量評価 <p>電中研報告^{*1}によるネットの吸収エネルギーは表7のとおりであり、当社の設計飛来物の速度条件を包絡する。</p> <div data-bbox="712 730 1326 970" style="border: 1px solid red; padding: 5px;"> <p>表7 竜巻防護ネット（金網部）の吸収エネルギーと設計飛来物の衝突エネルギー</p> <table border="1" style="width: 100%; border-collapse: collapse;"> <tr> <td style="text-align: center;">限界吸収エネルギー^{*2}</td> <td style="text-align: center;">183 (kJ)</td> </tr> <tr> <td style="text-align: center;">設計飛来物の衝突エネルギー (鋼製材：135kg, 速度 16.7m/s)</td> <td style="text-align: center;">19 (kJ)</td> </tr> </table> <p><small>※1：竜巻設計飛来物に対する防護ネットの評価手法と対策工法の提案（電力中央研究所報告書 N13014, 平成26年3月） ※2：電力中央研究所報告書O01「高強度金網を用いた竜巻設計飛来物対策工法の合理的な衝撃応答評価手法」</small></p> </div> <p>3.4.2 構造設計</p> <p>ネット（金網部）は、ひし形金網の高強度金網を使用しており、50mm目合いの主ネット2枚と40mm目合いの補助ネット1枚を重ねて取り付ける。</p> <p>ネット（金網部）は、金網部の端部にワイヤロープを通すことによって支持し、ワイヤロープの端部はフレームに取り付けた接続用の治具を介して、ワイヤロープ固定部に接続する。</p> <p>ネットに作用する自重や設計飛来物による衝撃荷重等の荷重は、ワイヤロープを通じてフレームに伝達する。</p> <p>ネットを取り付けるフレームは、主桁、横補強材、ブレースで構成</p>	限界吸収エネルギー ^{*2}	183 (kJ)	設計飛来物の衝突エネルギー (鋼製材：135kg, 速度 16.7m/s)	19 (kJ)	<p>3.4 ネット（金網部）の構造設計</p> <p>3.4.1 基本設計</p> <p>設計飛来物が衝突した際に局部的に生じる衝撃荷重に耐え、変形することにより設計飛来物の持つ運動エネルギーを吸収し、原子炉補機冷却海水ポンプ等への衝突を防止する。</p> <p>竜巻防護ネットの基本仕様は、電力中央研究所にて評価、試験を行い、検証されたものを適用し、防護性能の評価は以下のとおり実施する。設計の考え方については別紙1～7に示す。</p> <p>設計飛来物の衝突位置の影響として、中央位置からずれたオフセット位置に衝突する場合の影響を考慮する。</p> <ul style="list-style-type: none"> ・ネットの吸収エネルギー評価 ・ネットの破断評価 ・ネットのたわみ量評価 <p>電中研報告^{*1}によるネットの吸収エネルギーは表7のとおりであり、当社の設計飛来物の速度条件を包絡する。</p> <div data-bbox="1348 730 1962 1034" style="border: 1px solid red; padding: 5px;"> <p>表7 竜巻防護ネット（金網部）の吸収エネルギーと設計飛来物の衝突エネルギー</p> <table border="1" style="width: 100%; border-collapse: collapse;"> <thead> <tr> <th rowspan="2">設置場所</th> <th colspan="2">海水ポンプエリア上部開口部</th> <th colspan="2">海水ストレーナエリア上部開口部</th> </tr> <tr> <th>Aトレン</th> <th>Bトレン</th> <th>海側</th> <th>山側</th> </tr> </thead> <tbody> <tr> <td>ネット</td> <td></td> <td></td> <td></td> <td></td> </tr> <tr> <td>限界吸収エネルギー^{*2}</td> <td style="text-align: center;">324[kJ]</td> <td style="text-align: center;">327[kJ]</td> <td style="text-align: center;">252 [kJ]</td> <td style="text-align: center;">251 [kJ]</td> </tr> <tr> <td>設計飛来物の衝突エネルギー (鋼製材：135kg, 速度 38m/s)</td> <td colspan="4" style="text-align: center;">98 [kJ]</td> </tr> </tbody> </table> <p><small>※1：竜巻設計飛来物に対する防護ネットの評価手法と対策工法の提案（電力中央研究所報告書 N13014, 平成26年3月） ※2：電力中央研究所報告書O01「高強度金網を用いた竜巻設計飛来物対策工法の合理的な衝撃応答評価手法」</small></p> </div> <p>3.4.2 構造設計</p> <p>ネット（金網部）は、ひし形金網の高強度金網を使用しており、海水ポンプエリア開口部に設置するネット（金網部）は、50mm目合いの主ネット2枚と40mm目合いの補助ネット1枚を重ねて取り付ける。</p> <p>海水ストレーナエリア開口部に設置するネット（金網部）は、40mm目合いの主ネット2枚と40mm目合いの補助ネット1枚を重ねて取り付ける。</p> <p>ネット（金網部）は、金網部の端部にワイヤロープを通すことによって支持し、ワイヤロープの端部は鋼製棒に取り付けた接続用の治具を介して、ワイヤロープ固定部に接続する。</p> <p>ネット（金網部）に作用する自重や設計飛来物による衝撃荷重等の荷重は、ワイヤロープを通じて鋼製棒に伝達する。</p> <p>ネットを取り付ける鋼製棒は、ピット開口部の周囲に配した架台の</p>	設置場所	海水ポンプエリア上部開口部		海水ストレーナエリア上部開口部		Aトレン	Bトレン	海側	山側	ネット					限界吸収エネルギー ^{*2}	324[kJ]	327[kJ]	252 [kJ]	251 [kJ]	設計飛来物の衝突エネルギー (鋼製材：135kg, 速度 38m/s)	98 [kJ]				<p>る。</p> <p>【女川】 設置場所の相違</p> <p>【女川】 記載の充実 ・大飯審査実績の反映</p> <p>【女川】 ・設置状況の相違</p> <p>【女川】 ネットの仕様の相違。 泊はネットの面積が小さい海水ポンプ出口ストレーナ上部開口部については、主ネットも40mm目合いを採用していることによる相違</p> <p>【女川】 ・記載表現の相違</p> <p>【女川】</p>
限界吸収エネルギー ^{*2}	183 (kJ)																													
設計飛来物の衝突エネルギー (鋼製材：135kg, 速度 16.7m/s)	19 (kJ)																													
設置場所	海水ポンプエリア上部開口部		海水ストレーナエリア上部開口部																											
	Aトレン	Bトレン	海側	山側																										
ネット																														
限界吸収エネルギー ^{*2}	324[kJ]	327[kJ]	252 [kJ]	251 [kJ]																										
設計飛来物の衝突エネルギー (鋼製材：135kg, 速度 38m/s)	98 [kJ]																													

赤字：設備、運用又は体制の相違（設計方針の相違）
 青字：記載箇所又は記載内容の相違（記載方針の相違）
 緑字：記載表現、設備名称の相違（実質的な相違なし）

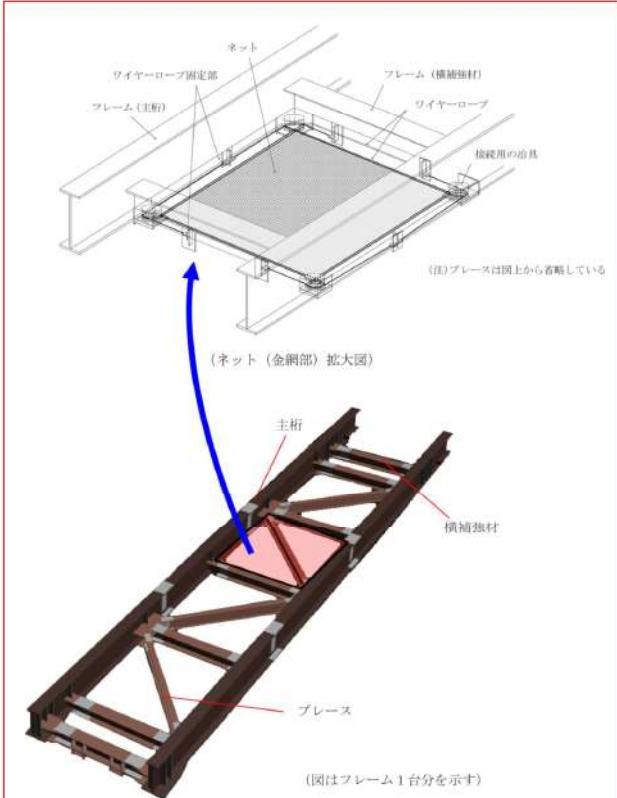
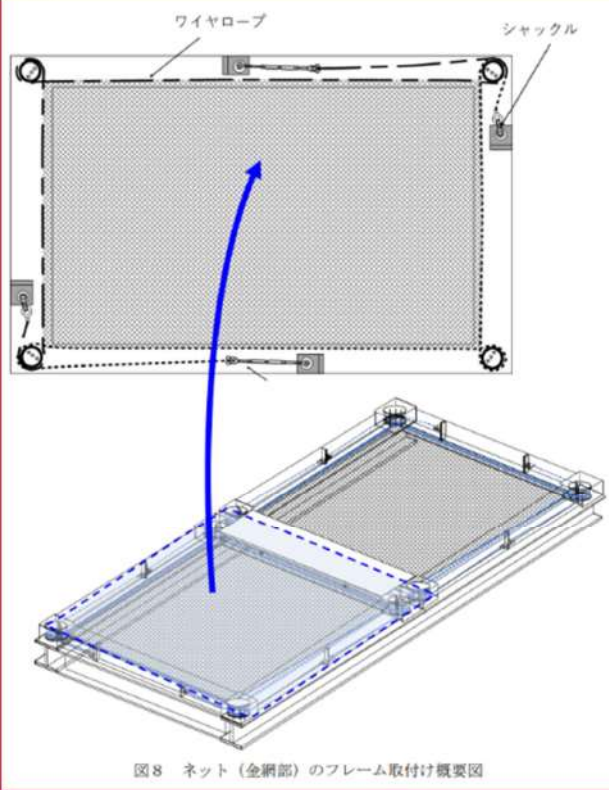
大飯発電所3/4号炉	女川原子力発電所2号炉	泊発電所3号炉	相違理由
	<p>され、主桁と横補強材で区切られるセル毎にネットを支持する。1台のフレームに対して、セルは4つとし、5台のフレームで海水ポンプ室のほぼ全域を覆う構造とする。ネット（金網部）のフレーム取付け概要を図8に示す。</p>  <p>図8 ネット（金網部）のフレーム取付け概要図</p> <p>3.5 フレーム、大梁の構造設計 3.5.1 基本設計 竜巻防護ネットのフレームは、設計飛来物の衝突において貫通が発生しない設計とする。 また、ネット（金網部）や防護板で受けた設計飛来物による衝撃荷重等が伝達されることから、荷重条件に対して上載するネット、防護板を支持可能な構造強度を有する設計とする。設計飛来物の衝突位置により各部材に加わる荷重が異なることから、設計飛来物衝突位置の影響を考慮した設計を実施する。 地震に対しては、耐震Cクラスの静的地震力に耐えるとともに、基準地震動Ssによる地震力によって崩壊及び落下せず、非常用海水ボ</p>	<p>上に固定し、架台及びブラケットに固定される。ネット（鋼製枠）の取付け概要を図8に示す。</p>  <p>図8 ネット（鋼製枠）のフレーム取付け概要図</p> <p>3.5 架台及びブラケットの構造設計 3.5.1 基本設計 竜巻防護ネットの架台は、設計飛来物の衝突において貫通が発生しない設計とする。 また、ネットやすり抜け防止用鋼材で受けた設計飛来物による衝撃荷重等が伝達されることから、荷重条件に対して上載するネット、すり抜け防止用鋼材を支持可能な構造強度を有する設計とする。設計飛来物の衝突位置により各部材に加わる荷重が異なることから、設計飛来物衝突位置の影響を考慮した設計を実施する。 地震に対しては、耐震Cクラスの静的地震力に耐えるとともに、基準地震動Ssによる地震力によって崩壊及び落下せず、原子炉補機冷</p>	<p>ネットの設置方法の相違</p> <p>【女川】 竜巻防護ネットの構造の相違</p> <p>【女川】 ネットの設置方法の相違</p> <p>【女川】 ネット構造の相違</p>

赤字：設備、運用又は体制の相違（設計方針の相違）
 青字：記載箇所又は記載内容の相違（記載方針の相違）
 緑字：記載表現、設備名称の相違（実質的な相違なし）

大飯発電所3/4号炉	女川原子力発電所2号炉	泊発電所3号炉	相違理由
	<p>ンブ等への波及的影響を与えることのない設計とする。海水ポンプ室補機ポンプエリアの壁部材等に対して、海水ポンプ室補機ポンプエリアの強度を踏まえた荷重支持位置を考慮することにより、耐震安全性を確保する。</p> <p>3.5.2 構造設計 ネット（金網部）及びフレームで発生した荷重は、海水ポンプ室補機ポンプエリアの壁面に伝達する構造とする。 海水ポンプ室の壁面のうち、隔壁（南側）は厚さ0.6mであり、荷重に対して十分な強度を確保できない可能性があるため、十分な厚み（厚さ2m）がある側壁（東側）及び側壁（西側）にブラケットを取付け、大梁を設置することで、フレームを支持する。もう一方の支持は厚さ1.5mの隔壁（北側）にて実施する。 以上により、十分な厚みがあり強度が確保できる隔壁（北側）と側壁（東側、西側）で荷重を受ける構造とする。 ゴム支承、可動支承に支持されているフレーム、ゴム支承に支持されている大梁は、地震力等によって水平方向の変位が生じることから、他の設備との干渉について考慮する必要がある。そのため、フレーム間及びフレームや大梁と海水ポンプ室補機ポンプエリア壁面との間に地震時に発生する変位を踏まえてクリアランスを確保する設計とする。 また、フレームを支持するゴム支承に期待しない場合でも竜巻防護ネットが非常用海水ポンプ等に落下しないように、フレーム等にストッパーを取り付けフレームの水平方向移動を拘束し、竜巻防護ネットの落下を防止する設計とする。 フレーム、大梁の設置状況を図9に示す。</p>	<p>却海水ポンプ等への波及的影響を与えることのない設計とする。 竜巻防護ネットのブラケットは、ネットやすり抜け防止用鋼材で受けた設計飛来物による衝撃荷重等が架台を介して伝達されることから、荷重条件に対して上載する架台を支持可能な構造強度を有する設計とする。</p> <p>3.5.2 構造設計 ネット及び架台で発生した荷重は、循環水ポンプ建屋床面及びブラケットに伝達する構造とする。 ブラケット部の架台で発生した荷重は、ブラケットを介して海水ポンプエリア壁面に伝達する構造とする。 海水ポンプエリア開口部周囲の床面のうち、原子炉補機冷却海水ポンプエリアの南側の一部については、架台を設置するスペースが十分に確保できないため、海水ポンプエリア壁面にブラケットを取付け、ネット及び架台を支持する。</p>	<p>【女川】 ネットの設置方法の相違</p> <p>【女川】 ネットの設置方法の相違</p> <p>【女川】 ・竜巻防護設備の構造の相違。 ・女川は竜巻防護ネットを設置する海水ポンプエリアの壁が薄く支持機能に期待できないため、可動支承、ゴム支承を採用して地震により生じる応力を低減・分散させる構造として、ネットの支持機能を確保している。 ・泊においては、女川と異なり竜巻防護ネットは強固な建屋床面、ブラケットを介してビット壁面に設置できる環境であることから、女川の竜巻防護ネットの可動支承のような可動式の機構を持たせる必要はない。 ・以上の理由から、泊の竜巻防護ネットは、先行プラント（大飯、高浜）と同様の竜巻防護ネットの構造を採用しており、架構に直接、竜巻防護ネットを設置する構造としてい</p>

赤字：設備、運用又は体制の相違（設計方針の相違）
 青字：記載箇所又は記載内容の相違（記載方針の相違）
 緑字：記載表現、設備名称の相違（実質的な相違なし）

大飯発電所3/4号炉	女川原子力発電所2号炉	泊発電所3号炉	相違理由
	 <p>3.6 ゴム支承、可動支承の構造設計</p> <p>3.6.1 基本設計</p> <p>地震によるフレーム、大梁の発生応力及び海水ポンプ室補機ポンプエリア壁面への支点反力を低減・分散させることを目的として、支持部にはゴム支承を採用する。また、フレームと大梁の接続部には、温度変化によるフレームの伸縮を吸収し、変形による荷重発生を防ぐため、水平変位に追従する可動支承を設置する。</p> <p>ゴム支承を用いることの効果としては、以下のとおり。</p> <ul style="list-style-type: none"> ・竜巻防護ネットの水平方向の固有周期を長周期側に移動させることで、応答を下げるができる。 ・大梁の両端で水平力を支持し、海水ポンプ室壁面への荷重を分散することができる。 <p>地震に対しては、耐震Cクラスの静的地震力に耐えるとともに、基準地震動Ssによる地震力によって崩壊及び落下せず、非常用海水ポンプ等への波及的影響を与えることのない設計とする。竜巻に対しては、ネット（金網部）や防護板及びフレームで受けた設計飛来物による衝撃荷重等が伝達されることから、竜巻による荷重に対して上載するフレーム等を支持可能な構造強度を有する設計とする。</p> <p>3.6.2 構造設計</p> <p>ゴム支承はフレームと隔壁（北側）の接続部及び大梁とブラケットの接続部に設置する。</p> <p>フレームと隔壁（北側）の接続部は、フレーム1基に対して、隔壁（北側）の天面に設置した2個のゴム支承を取り付ける構造とする。（隔壁（北側）には計10個のゴム支承を設置）</p>		<p>る。</p> <p>【女川】</p> <ul style="list-style-type: none"> ・竜巻防護設備の構造の相違。 ・女川は竜巻防護ネットを設置する海水ポンプエリアの壁が薄く支持機能に期待できないため、可動支承、ゴム支承を採用して地震により生じる応力を低減・分散させる構造として、ネットの支持機能を確認している。 ・泊においては、女川と異なり竜巻防護ネットは強固な建屋床面、ブラケットを介してピット壁面に設置できる環境であることから、女川の竜巻防護ネットの可動支承のような可動式の機構を持たせる必要はない。 ・以上の理由から、泊の竜巻防護ネットは、先行プラント（大飯、高浜）と同様の竜巻防護ネットの構造を採用しており、架構に直接、竜巻防護ネットを設置する構造としている。

赤字：設備、運用又は体制の相違（設計方針の相違）
 青字：記載箇所又は記載内容の相違（記載方針の相違）
 緑字：記載表現、設備名称の相違（実質的な相違なし）

大飯発電所3/4号炉	女川原子力発電所2号炉	泊発電所3号炉	相違理由
	<p>大梁の支持は、片側1箇所あたり2基のブラケットを設置し、各ブラケットの上に1個のゴム支承を設置する。（ブラケットには計4個のゴム支承を設置）</p> <p>大梁とフレームの接続部は可動支承を用いる。可動支承はフレーム1基に対して、2個の可動支承で支持する。（大梁には計10個の可動支承を設置）可動方向は南北方向のみである。</p> <p>支持構造模式図を図10、ゴム支承及び可動支承概略図を図11に示す。</p>  <p>図10 支持構造模式図</p>		<p>【女川】</p> <ul style="list-style-type: none"> ・竜巻防護設備の構造の相違。 ・女川は竜巻防護ネットを設置する海水ポンプエリアの壁が薄く支持機能に期待できないため、可動支承、ゴム支承を採用して地震により生じる応力を低減・分散させる構造として、ネットの支持機能を確認している。 ・泊においては、女川と異なり竜巻防護ネットは強固な建屋床面、ブラケットを介してビット壁面に設置できる環境であることから、女川の竜巻防護ネットの可動支承のような可動式の機構を持たせる必要はない。 ・以上の理由から、泊の竜巻防護ネットは、先行プラント（大飯、高浜）と同様の竜巻防護ネットの構造を採用しており、架構に直接、竜巻防護ネットを設置する構造としている。

赤字：設備、運用又は体制の相違（設計方針の相違）
 青字：記載箇所又は記載内容の相違（記載方針の相違）
 緑字：記載表現、設備名称の相違（実質的な相違なし）

大飯発電所3/4号炉	女川原子力発電所2号炉	泊発電所3号炉	相違理由
	<p>図 11 ゴム支承及び可動支承概略図</p>		

赤字：設備、運用又は体制の相違（設計方針の相違）
 青字：記載箇所又は記載内容の相違（記載方針の相違）
 緑字：記載表現、設備名称の相違（実質的な相違なし）

大飯発電所3/4号炉	女川原子力発電所2号炉	泊発電所3号炉	相違理由																			
	<p>3.7 防護板の構造設計</p> <p>3.7.1 基本設計</p> <p>竜巻防護ネットのうち、ゴム支承に支持されているフレーム、大梁は、地震力によって水平方向の変位が生じることから、他の設備との干渉を回避する必要がある。このため、フレーム間及びフレームと海水ポンプ室補機ポンプエリア壁面との間に隙間を設けており、隙間からの設計飛来物の侵入を防ぐために、防護板を設置する。</p> <p>防護板は、設計飛来物の衝突に対して、BRL式※3を用いて算出される貫通限界厚さ以上の板厚を確保することで、貫通せず変形に留まる設計とする。また、防護板は地震時にフレームが移動しても干渉しない構造であるとともに、設計飛来物である鋼製材が海水ポンプ室補機ポンプエリアに侵入しない構造とする。</p> <p>3.7.2 構造設計</p> <p>竜巻防護ネットの5台のフレームは、地震時に発生する変位を踏まえて隙間を確保している。また、同様に海水ポンプ室補機ポンプエリアの側壁との間にも隙間を設けている。防護板はフレームの変位を考慮した上で、ラビリンス構造とすることで、設計飛来物である鋼製材（縦4.2m×横0.3m×高さ0.2m）が通過しない構造とする。</p> <p>また、BRL式による貫通厚さは表8に示すとおりであり、防護板に対する垂直方向の衝突を考慮する。図12にフレーム、防護板等の配置イメージを示す。</p> <table border="1" data-bbox="712 810 1326 1008"> <caption>表8 BRL式※3による貫通厚さ</caption> <thead> <tr> <th rowspan="2">設計飛来物</th> <th colspan="2">仕様</th> <th colspan="2">貫通限界厚さ (mm)</th> </tr> <tr> <th>サイズ (m)</th> <th>質量 (kg)</th> <th>水平方向の衝突</th> <th>鉛直方向の衝突</th> </tr> </thead> <tbody> <tr> <td>鋼製材</td> <td>縦×横×高さ 4.2×0.3×0.2</td> <td>135</td> <td>27.6</td> <td>7.1</td> </tr> <tr> <td>(参考) 砂利</td> <td>縦×横×高さ 0.04×0.04×0.04</td> <td>0.2</td> <td>0.9</td> <td>0.2</td> </tr> </tbody> </table> <p>※3：「タービンミサイル評価について(昭和52年7月20日 原子炉安全専門審査会)」で用いられているBRL式</p>	設計飛来物	仕様		貫通限界厚さ (mm)		サイズ (m)	質量 (kg)	水平方向の衝突	鉛直方向の衝突	鋼製材	縦×横×高さ 4.2×0.3×0.2	135	27.6	7.1	(参考) 砂利	縦×横×高さ 0.04×0.04×0.04	0.2	0.9	0.2	<p>3.6 すり抜け防止用鋼材の構造設計</p> <p>3.6.1 基本設計</p> <p>竜巻防護ネットのうち、すり抜け防止用鋼材は、ネット（鋼製棒）間の隙間から設計飛来物の侵入を防ぐために、防護板を設置する。</p> <p>3.6.2 構造設計</p> <p>すり抜け防止用鋼材は、設計飛来物である鋼製材（縦4.2m×横0.3m×高さ0.2m）が通過しない構造とする。</p>	<p>【女川】 記載表現の相違</p> <p>【女川】 防護ネットの構成部材の相違</p> <p>【女川】 記載表現の相違</p> <p>【女川】 防護ネットの構成部材の相違 評価結果については設工認で説明する方針。</p>
設計飛来物	仕様		貫通限界厚さ (mm)																			
	サイズ (m)	質量 (kg)	水平方向の衝突	鉛直方向の衝突																		
鋼製材	縦×横×高さ 4.2×0.3×0.2	135	27.6	7.1																		
(参考) 砂利	縦×横×高さ 0.04×0.04×0.04	0.2	0.9	0.2																		

赤字：設備、運用又は体制の相違（設計方針の相違）
 青字：記載箇所又は記載内容の相違（記載方針の相違）
 緑字：記載表現、設備名称の相違（実質的な相違なし）

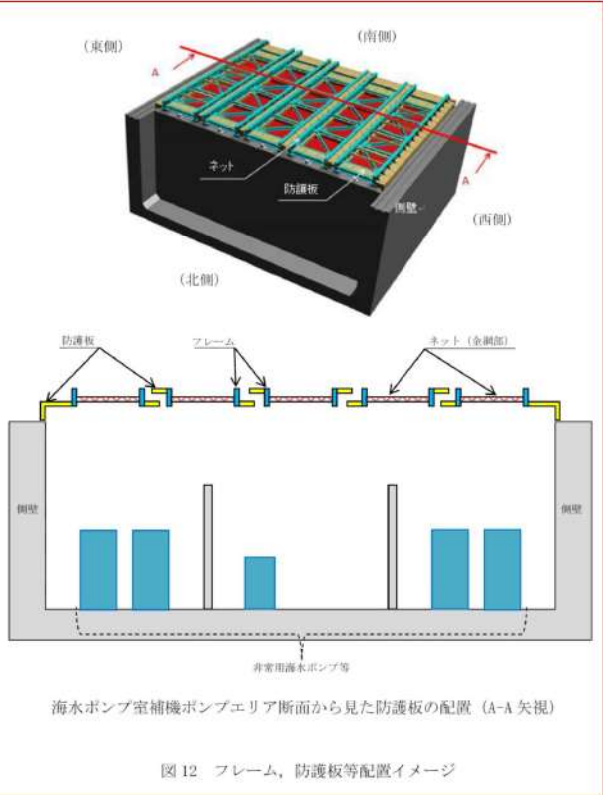
大飯発電所3/4号炉	女川原子力発電所2号炉	泊発電所3号炉	相違理由
	 <p>図12 フレーム、防護板等配置イメージ</p> <p>3.8 ゴム支承、可動支承の採用による設計への反映事項 3.8.1 ゴム支承、可動支承の影響に対する検討 竜巻防護ネットの各構造に対して、設計竜巻荷重より外部事象防護対象施設である非常用海水ポンプ等を防護できない事象（損傷モード）を検討し、その損傷モードを踏まえ、各部位に必要な評価項目及び構造強度上の評価方針を整理する。ゴム支承、可動支承の特性を考慮し、ゴム支承、可動支承の採用による設計上の配慮又は対策を抽出する。 抽出された設計上の配慮又は対策に対する対応方針を検討し、設計に反映する。検討フローを図13、ゴム支承、可動支承の特性を表9、竜巻防護ネットの損傷モードを整理した結果を表10に示す。</p>	<p>竜巻防護ネットの損傷モードを整理した結果を表8に示す。</p>	<p>【女川】</p> <ul style="list-style-type: none"> ・竜巻防護設備の構造の相違。 ・女川は竜巻防護ネットを設置する海水ポンプエリアの壁が薄く支持機能に期待できないため、可動支承、ゴム支承を採用して地震により生じる応力を低減・分散させる構造として、ネットの支持機能を確保している。 ・泊においては、女川と異なり竜巻防護ネットは強固な建屋床面、ブラケットを介してピット壁面に設置できる環境であることから、女川の竜巻防護ネットの可動支承のような可動式の機構を持たせる必要はない。 ・以上の理由から、泊の竜巻防護ネットは、先行プラント（大飯、高浜）と同様の竜巻防護ネットの構造を採用しており、架構に直接、竜巻防護ネットを設置する構造としている。 <p>【女川】 記載表現の相違</p>

赤字：設備、運用又は体制の相違（設計方針の相違）
 青字：記載箇所又は記載内容の相違（記載方針の相違）
 緑字：記載表現、設備名称の相違（実質的な相違なし）

大飯発電所3/4号炉	女川原子力発電所2号炉	泊発電所3号炉	相違理由							
	<div data-bbox="712 145 1317 564" data-label="Diagram"> <p>図13 ゴム支承、可動支承の影響に対する検討フロー</p> </div> <div data-bbox="712 616 1317 794" data-label="Table"> <p>表9 ゴム支承、可動支承の特性</p> <table border="1"> <thead> <tr> <th>支承の種類</th> <th>特性</th> </tr> </thead> <tbody> <tr> <td rowspan="2">ゴム支承</td> <td>作用荷重により変形する</td> </tr> <tr> <td>荷重の伝達時に、反力を低減・分散する</td> </tr> <tr> <td>可動支承</td> <td>すべり機構により、1軸方向に可動する</td> </tr> </tbody> </table> </div>	支承の種類	特性	ゴム支承	作用荷重により変形する	荷重の伝達時に、反力を低減・分散する	可動支承	すべり機構により、1軸方向に可動する		<p>【女川】</p> <ul style="list-style-type: none"> ・竜巻防護設備の構造の相違。 ・女川は竜巻防護ネットを設置する海水ポンプエリアの壁が薄く支持機能に期待できないため、可動支承、ゴム支承を採用して地震により生じる応力を低減・分散させる構造として、ネットの支持機能を確保している。 ・泊においては、女川と異なり竜巻防護ネットは強固な建屋床面、ブラケットを介してピット壁面に設置できる環境であることから、女川の竜巻防護ネットの可動支承のような可動式の機構を持たせる必要はない。 ・以上の理由から、泊の竜巻防護ネットは、先行プラント（大飯、高浜）と同様の竜巻防護ネットの構造を採用しており、架構に直接、竜巻防護ネットを設置する構造としている。
支承の種類	特性									
ゴム支承	作用荷重により変形する									
	荷重の伝達時に、反力を低減・分散する									
可動支承	すべり機構により、1軸方向に可動する									

赤字：設備、運用又は体制の相違（設計方針の相違）
 青字：記載箇所又は記載内容の相違（記載方針の相違）
 緑字：記載表現、設備名称の相違（実質的な相違なし）

大飯発電所3/4号炉

女川原子力発電所2号炉

泊発電所3号炉

相違理由

表10 竜巻防護ネットの損傷モード整理表(1/6)

評価対象	作用荷重	損傷モード	評価項目	構造強度上の評価方針	ゴム支承、可動支保架使用による設計上の配慮又は対策
ネット (金網部)	衝撃荷重 竜巻風荷重 自重	ネットの破断による設計飛来物の防護対象施設への衝突	【喚起エネルギー評価】	ネットに設計飛来物が衝突した場合に、限界喚起エネルギーが作用荷重によるエネルギー以上であることを確認する（電中研報告書 ^{※1} による評価）	ゴム支承、可動支保架使用による設計上の配慮又は対策
			【破断評価】	ネットに設計飛来物が衝突した場合に、防護対象施設までの距離短縮が作用荷重によるワイヤロープのたわみ量以上であることを確認する（電中研報告書 ^{※1} による評価）	
ワイヤロープ ターンバックル シャックル 接続器具	衝撃荷重 竜巻風荷重 自重	ネットがたわむことによる設計飛来物の防護対象施設への衝突	【たわみ評価】	ネットに設計飛来物が衝突した場合に、防護対象施設までの距離短縮が作用荷重によるワイヤロープのたわみ量以上であることを確認する	(1)衝撃荷重に対するゴム支承・可動支保架の必要性がある
		ネットがたわむことによる設計飛来物の防護対象施設への衝突	【たわみ評価】	ネットに設計飛来物が衝突した場合に、防護対象施設までの距離短縮が作用荷重によるワイヤロープのたわみ量以上であることを確認する	
		部材の破断による設計飛来物の防護対象施設への衝突	【破断評価】	ネットに設計飛来物が衝突した場合に、作用する荷重が素材の持つ破断強度以下であることを確認する	
		部材の破断による設計飛来物の防護対象施設への衝突	【破断評価】	ネットに設計飛来物が衝突した場合に、作用する荷重が素材の持つ破断強度以下であることを確認する	

※1:竜巻設計飛来物に対する防護ネットの評価手法と対策工法の概要(電力中央研究所報告 N1304、平成25年3月)、電力中央研究所東部DB「高強度金網を用いた竜巻設計飛来物対策工の合理的な実施設計評価手法」

表8 竜巻防護ネットの損傷モード整理表(1/2)

評価対象	作用荷重	損傷モード	評価項目	構造強度上の評価方針
ネット (金網部)	衝撃荷重 竜巻風荷重 自重	ネットの破断による設計飛来物の防護対象施設への衝突	【喚起エネルギー評価】	ネットに設計飛来物が衝突した場合に、限界喚起エネルギーが作用荷重によるエネルギー以上であることを確認する（電中研報告書 ^{※1} による評価）
		ネットがたわむことによる設計飛来物の防護対象施設への衝突	【破断評価】	ネットに設計飛来物が衝突した場合に、防護対象施設までの距離短縮が作用荷重によるワイヤロープのたわみ量以上であることを確認する
ワイヤロープ ターンバックル シャックル 接続器具	衝撃荷重 竜巻風荷重 自重	部材の破断による設計飛来物の防護対象施設への衝突	【たわみ評価】	ネットに設計飛来物が衝突した場合に、作用する荷重が素材の持つ破断強度以下であることを確認する
		部材の破断による設計飛来物の防護対象施設への衝突	【たわみ評価】	ネットに設計飛来物が衝突した場合に、作用する荷重が素材の持つ破断強度以下であることを確認する
		部材の破断による設計飛来物の防護対象施設への衝突	【破断評価】	ネットに設計飛来物が衝突した場合に、防護対象施設までの距離短縮が作用荷重によるワイヤロープのたわみ量以上であることを確認する
		部材の破断による設計飛来物の防護対象施設への衝突	【破断評価】	ネットに設計飛来物が衝突した場合に、作用する荷重が素材の持つ破断強度以下であることを確認する

※1:竜巻設計飛来物に対する防護ネットの評価手法と対策工法の概要(電力中央研究所報告 N1304、平成25年3月)、電力中央研究所東部DB「高強度金網を用いた竜巻設計飛来物対策工の合理的な実施設計評価手法」

【女川】
 ・竜巻防護設備の構造の相違。
 ・女川は竜巻防護ネットを設置する海水ポンプエリアの壁が薄く支持機能に期待できないため、可動支保、ゴム支保を採用して地震により生じる応力を低減・分散させる構造として、ネットの支持機能を確保している。
 ・泊においては、女川と異なり竜巻防護ネットは強固な建屋床面、ブラケットを介してビット壁面に設置できる環境であることから、女川の竜巻防護ネットの可動支保のような可動式の機構を持たせる必要はない。
 ・以上の理由から、泊の竜巻防護ネットは、先行プラント（大飯、高浜）と同様の竜巻防護ネットの構造を採用しており、架構に直接、竜巻防護ネットを設置する構造としている。

【女川】
 記載表現の相違（表番号）

赤字：設備、運用又は体制の相違（設計方針の相違）
 青字：記載箇所又は記載内容の相違（記載方針の相違）
 緑字：記載表現、設備名称の相違（実質的な相違なし）

大飯発電所3/4号炉

女川原子力発電所2号炉

泊発電所3号炉

相違理由

表10 竜巻防護ネットの損傷モード整理表(2/6)

評価対象	評価モード	損傷モード	評価項目	構造強度上の評価方針	ゴム支承・可動支承採用による設計上の気候互換対策
防風板	主桁 横断強材	主桁、横断強材を貫通することによる設計対象物の防護対象施設への衝突	【貫通評価】 図1式による板厚評価	設計対象物が支持部に衝突した場合、衝突箇所に発生する衝撃荷重によって貫通が起きないように、フレームの剛性が終局状態に至るようなひずみを生じないことを確認する	(1) 衝撃荷重に対するゴム支承・可動支承の剛性を評価し、必要がある場合は必要となる
			【貫通評価】 ひずみ量	設計対象物が支持部に衝突した場合、衝突箇所に発生する衝撃荷重によって貫通が起きないように、フレームの剛性が終局状態に至るようなひずみを生じないことを確認する	(1) 衝撃荷重に対するゴム支承・可動支承の剛性を評価し、必要がある場合は必要となる
フレーム	フレーム全体	フレームに設計対象物が衝突すること、破断・落下し防護対象施設に衝突	【貫通評価】 せん断応力 曲げ応力 引張応力	フレームはネットの上部に設置しており、破断したフレームによる荷重の影響は、設計対象物におけるネットの破断エネルギー評価、竜巻評価に反映される	(1) 衝撃荷重に対するゴム支承・可動支承の剛性を評価し、必要がある場合は必要となる
			【貫通評価】 せん断応力 曲げ応力 引張応力	フレームはネットの上部に設置しており、破断したフレームによる荷重の影響は、設計対象物におけるネットの破断エネルギー評価、竜巻評価に反映される	(1) 衝撃荷重に対するゴム支承・可動支承の剛性を評価し、必要がある場合は必要となる
スタックパー	スタックパー	スタックパーに設計対象物が衝突すること、破断・落下し防護対象施設に衝突	【支持機能評価】 せん断応力 曲げ応力	竜巻の風圧力により発生する衝撃荷重に耐え、破断しないことを確認する	(2) スタックパーの設置（許容応力に対し強度を有する設計） (3) 作用荷重によるフレームの変位に対する影響を確認する必要がある
			【支持機能評価】 せん断応力 曲げ応力	竜巻の風圧力により発生する衝撃荷重に耐え、破断しないことを確認する	(2) スタックパーの設置（許容応力に対し強度を有する設計） (3) 作用荷重によるフレームの変位に対する影響を確認する必要がある

表10(ラーベータ)の記載内容については、図面等に基づいて確認済みである。

表8 竜巻防護ネットの損傷モード整理表(2/2)

評価対象	作用荷重	損傷モード	評価項目	構造強度上の評価方針
すり抜け防止用剛材	衝撃荷重 竜巻風荷重 自重	防護板を貫通することによる設計対象物への防護対象施設への衝突	【貫通評価】 ひずみ量	衝突箇所に発生する衝撃荷重によって貫通が生じないよう、終局状態に至るようなひずみを生じないことを確認する
			【貫通評価】 ひずみ量	設計対象物が支持部に衝突した場合、衝突箇所に発生する衝撃荷重によって貫通が生じないよう、終局状態に至るようなひずみを生じないことを確認する
支持部材	衝撃荷重 竜巻風荷重 自重	架台に設計対象物が衝突することによる破断・落下し防護対象施設に衝突	【支持機能評価】 せん断応力 曲げ応力 引張応力	竜巻の風圧力による荷重及び設計対象物による衝撃荷重に対し、上載するネットを支持するため、架台の剛性が終局状態に至るようなひずみを生じないことを確認する
			【支持機能評価】 せん断応力 曲げ応力 引張応力	竜巻の風圧力による荷重及び設計対象物による衝撃荷重に対し、上載するネットを支持するため、架台の剛性が終局状態に至るようなひずみを生じないことを確認する

【女川】
 ・竜巻防護設備の構造の相違。
 ・女川は竜巻防護ネットを設置する海水ポンプエリアの壁が薄く支持機能に期待できないため、可動支承、ゴム支承を採用して地震により生じる応力を低減・分散させる構造として、ネットの支持機能を確保している。
 ・泊においては、女川と異なり竜巻防護ネットは強固な建屋床面、ブラケットを介してピット壁面に設置できる環境であることから、女川の竜巻防護ネットの可動支承のような可動式の機構を持たせる必要はない。
 ・以上の理由から、泊の竜巻防護ネットは、先行プラント（大飯、高浜）と同様の竜巻防護ネットの構造を採用しており、架構に直接、竜巻防護ネットを設置する構造としている。

【女川】
 記載表現の相違（表番号）

赤字：設備、運用又は体制の相違（設計方針の相違）
 青字：記載箇所又は記載内容の相違（記載方針の相違）
 緑字：記載表現、設備名称の相違（実質的な相違なし）

大飯発電所3/4号炉	女川原子力発電所2号炉	泊発電所3号炉	相違理由
表 10 竜巻防護ネットの損傷モード整理表(3/6)			
評価対象	損傷モード	評価項目	構造強度上の評価方針
大梁	衝撃荷重 竜巻風荷重 ネット荷重 フレーム荷重 自重	【支持機能評価】 せん断応力 曲げ応力	ゴム支承、可動支承採用による設計上の配慮又は対策 (1) 衝撃解析に対するゴム支承・可動支承の影響に配慮する必要がある (2) 作用荷重による大梁の変位に対する影響に配慮する必要がある (3) 作用荷重による大梁の変位に対する影響に配慮する必要がある
ゴム体	衝撃荷重 竜巻風荷重 ネット荷重 フレーム荷重 自重	【支持機能評価】 引張応力 圧縮応力 せん断ひずみ	竜巻の風圧力による荷重及び設計飛来物による衝撃荷重に 対し、支持機能を維持するた め、作用する応力が「道路橋 示方書・同解説 V 耐震設計編 (H14.3)」に基づく基準値を超 えないうことを確認する。
フレーム ゴム支承 *1	内部鋼板 ゴム支承 取付ボルト アンカーボルト	【支持機能評価】 引張応力 【支持機能評価】 引張応力 せん断応力	竜巻の風圧力による荷重及び設計飛来物による衝撃荷重に 対し、支持機能を維持するた め、作用する応力が許容応力状 態IVSの許容応力を超えない ことを確認する。
*1:フレームゴム支承は、2つ以上の支承が構造強度上の評価方針を満足することを確認する。			

【女川】

- ・竜巻防護設備の構造の相違。
- ・女川は竜巻防護ネットを設置する海水ポンプエリアの壁が薄く支持機能に期待できないため、可動支承、ゴム支承を採用して地震により生じる応力を低減・分散させる構造として、ネットの支持機能を確保している。
- ・泊においては、女川と異なり竜巻防護ネットは強固な建屋床面、ブラケットを介してピット壁面に設置できる環境であることから、女川の竜巻防護ネットの可動支承のような可動式の機構を持たせる必要はない。
- ・以上の理由から、泊の竜巻防護ネットは、先行プラント（大飯、高浜）と同様の竜巻防護ネットの構造を採用しており、架構に直接、竜巻防護ネットを設置する構造としている。

赤字：設備、運用又は体制の相違（設計方針の相違）
 青字：記載箇所又は記載内容の相違（記載方針の相違）
 緑字：記載表現、設備名称の相違（実質的な相違なし）

大飯発電所3/4号炉	女川原子力発電所2号炉	泊発電所3号炉	相違理由																				
表 10 竜巻防護ネットの損傷モード整理表(4/6)																							
	<table border="1" data-bbox="716 167 1057 1295"> <thead> <tr> <th>評価対象</th> <th>作用荷重</th> <th>損傷モード</th> <th>評価項目</th> <th>構造強度上の評価方針</th> <th>ゴム支承、可動支承採用による設計上の配慮又は対策</th> </tr> </thead> <tbody> <tr> <td rowspan="3">大梁ゴム支承</td> <td>ゴム体</td> <td>ゴム体の破断によるアイソレート機能の喪失</td> <td>【支持機能評価】 引張応力 圧縮応力 せん断ひずみ</td> <td>竜巻の風圧力による衝撃及び設計飛来物による衝撃荷重に対し、支持機能を維持するた め、作用する応力等が「道路橋示方書・同解説Ⅴ耐震設計編（旧4.3）」に基づき基準値を超えないことを確認する</td> <td rowspan="3"> (1) 衝撃荷重に対するゴム支承・可動支承の影響に配慮する必要がある (2) 作用荷重による大梁の変位に対する影響に配慮する必要がある (3) 作用荷重による大梁の変位に対する影響に配慮する必要がある </td> </tr> <tr> <td>内部鋼板</td> <td>内部鋼板の破損によるアイソレート機能の喪失</td> <td>【支持機能評価】 引張応力</td> <td>竜巻の風圧力による衝撃及び設計飛来物による衝撃荷重に対し、支持機能を維持するた め、作用する応力が許容応力 其他IVSの許容応力を超えないことを確認する</td> </tr> <tr> <td>大梁ゴム支承取付ボルト</td> <td>破損によるアイソレート機能の喪失</td> <td>【支持機能評価】 引張応力 せん断応力</td> <td></td> </tr> </tbody> </table>	評価対象	作用荷重	損傷モード	評価項目	構造強度上の評価方針	ゴム支承、可動支承採用による設計上の配慮又は対策	大梁ゴム支承	ゴム体	ゴム体の破断によるアイソレート機能の喪失	【支持機能評価】 引張応力 圧縮応力 せん断ひずみ	竜巻の風圧力による衝撃及び設計飛来物による衝撃荷重に対し、支持機能を維持するた め、作用する応力等が「道路橋示方書・同解説Ⅴ耐震設計編（旧4.3）」に基づき基準値を超えないことを確認する	(1) 衝撃荷重に対するゴム支承・可動支承の影響に配慮する必要がある (2) 作用荷重による大梁の変位に対する影響に配慮する必要がある (3) 作用荷重による大梁の変位に対する影響に配慮する必要がある	内部鋼板	内部鋼板の破損によるアイソレート機能の喪失	【支持機能評価】 引張応力	竜巻の風圧力による衝撃及び設計飛来物による衝撃荷重に対し、支持機能を維持するた め、作用する応力が許容応力 其他IVSの許容応力を超えないことを確認する	大梁ゴム支承取付ボルト	破損によるアイソレート機能の喪失	【支持機能評価】 引張応力 せん断応力			<p>【女川】</p> <ul style="list-style-type: none"> 竜巻防護設備の構造の相違。 女川は竜巻防護ネットを設置する海水ポンプエリアの壁が薄く支持機能に期待できないため、可動支承、ゴム支承を採用して地震により生じる応力を低減・分散させる構造として、ネットの支持機能を確保している。 泊においては、女川と異なり竜巻防護ネットは強固な建屋床面、ブラケットを介してピット壁面に設置できる環境であることから、女川の竜巻防護ネットの可動支承のような可動式の機構を持たせる必要はない。 以上の理由から、泊の竜巻防護ネットは、先行プラント（大飯、高浜）と同様の竜巻防護ネットの構造を採用しており、架構に直接、竜巻防護ネットを設置する構造としている。
評価対象	作用荷重	損傷モード	評価項目	構造強度上の評価方針	ゴム支承、可動支承採用による設計上の配慮又は対策																		
大梁ゴム支承	ゴム体	ゴム体の破断によるアイソレート機能の喪失	【支持機能評価】 引張応力 圧縮応力 せん断ひずみ	竜巻の風圧力による衝撃及び設計飛来物による衝撃荷重に対し、支持機能を維持するた め、作用する応力等が「道路橋示方書・同解説Ⅴ耐震設計編（旧4.3）」に基づき基準値を超えないことを確認する	(1) 衝撃荷重に対するゴム支承・可動支承の影響に配慮する必要がある (2) 作用荷重による大梁の変位に対する影響に配慮する必要がある (3) 作用荷重による大梁の変位に対する影響に配慮する必要がある																		
	内部鋼板	内部鋼板の破損によるアイソレート機能の喪失	【支持機能評価】 引張応力	竜巻の風圧力による衝撃及び設計飛来物による衝撃荷重に対し、支持機能を維持するた め、作用する応力が許容応力 其他IVSの許容応力を超えないことを確認する																			
	大梁ゴム支承取付ボルト	破損によるアイソレート機能の喪失	【支持機能評価】 引張応力 せん断応力																				

赤字：設備、運用又は体制の相違（設計方針の相違）
 青字：記載箇所又は記載内容の相違（記載方針の相違）
 緑字：記載表現、設備名称の相違（実質的な相違なし）

大飯発電所3/4号炉	女川原子力発電所2号炉	泊発電所3号炉	相違理由																																																																																																								
表10 竜巻防護ネットの損傷モード整理表(5/6)																																																																																																											
<table border="1"> <thead> <tr> <th>評価対象</th> <th>作用原状</th> <th>損傷モード</th> <th>評価項目</th> <th>構造強度上の評価方針</th> <th>ゴム支承、可動支承採用による設計上の配慮又は対策</th> </tr> </thead> <tbody> <tr> <td rowspan="10">可動支承</td> <td rowspan="10">新巻荷重 竜巻荷重 ネット自重 フレーム荷重 自重</td> <td>ソーラープレート</td> <td>破断によるすべり機能喪失・回着 破断による隣のフレームへの衝突</td> <td>【支持機能評価】 支圧応力</td> <td>竜巻の風圧力による荷重及び設計乗乗物による衝撃荷重に対し、支持機能を維持するため、作用する応力が許容応力状態N/Sの許容応力を超えないことを確認する</td> </tr> <tr> <td>すべり材</td> <td>圧縮破断によるすべり機能喪失・回着</td> <td>【支持機能評価】 支圧応力</td> <td>竜巻の風圧力による荷重及び設計乗乗物による衝撃荷重に対し、支持機能を維持するため、作用する応力がマーガラーの許容応力を超えないことを確認する</td> </tr> <tr> <td>圧縮ゴム</td> <td>圧縮破断によるすべり機能喪失・回着</td> <td>【支持機能評価】 支圧応力</td> <td></td> </tr> <tr> <td>ピストン</td> <td>圧縮破断によるすべり機能喪失・回着</td> <td>【支持機能評価】 曲げ応力</td> <td></td> </tr> <tr> <td>理念</td> <td>圧縮破断によるすべり機能喪失・回着</td> <td>【支持機能評価】 支圧応力</td> <td></td> </tr> <tr> <td>突出部</td> <td>破断によるすべり機能喪失・回着</td> <td>【支持機能評価】 せん断応力 曲げ応力 支圧応力</td> <td></td> </tr> <tr> <td>ベース ジョット</td> <td>破断によるすべり機能喪失・回着</td> <td>【支持機能評価】 支圧応力</td> <td></td> </tr> <tr> <td>支圧部</td> <td>圧縮破断によるすべり機能喪失・回着</td> <td>【支持機能評価】 支圧応力</td> <td></td> </tr> <tr> <td>レール</td> <td>破断によるすべり機能喪失・回着</td> <td>【支持機能評価】 引張応力 せん断応力</td> <td>竜巻の風圧力による荷重及び設計乗乗物による衝撃荷重に対し、支持機能を維持するため、作用する応力が許容応力状態N/Sの許容応力を超えないことを確認する</td> </tr> <tr> <td>レール取付ボルト エンドプレート 接合ボルト 上部接合ボルト 下部接合ボルト</td> <td>破断によるすべり機能喪失・回着</td> <td>【支持機能評価】 引張応力 せん断応力</td> <td></td> </tr> <tr> <td>ベースプレート</td> <td>破断による隣のフレームへの衝突</td> <td>【支持機能評価】 曲げ応力 せん断応力</td> <td></td> </tr> </tbody> </table>	評価対象	作用原状	損傷モード	評価項目	構造強度上の評価方針	ゴム支承、可動支承採用による設計上の配慮又は対策	可動支承	新巻荷重 竜巻荷重 ネット自重 フレーム荷重 自重	ソーラープレート	破断によるすべり機能喪失・回着 破断による隣のフレームへの衝突	【支持機能評価】 支圧応力	竜巻の風圧力による荷重及び設計乗乗物による衝撃荷重に対し、支持機能を維持するため、作用する応力が許容応力状態N/Sの許容応力を超えないことを確認する	すべり材	圧縮破断によるすべり機能喪失・回着	【支持機能評価】 支圧応力	竜巻の風圧力による荷重及び設計乗乗物による衝撃荷重に対し、支持機能を維持するため、作用する応力がマーガラーの許容応力を超えないことを確認する	圧縮ゴム	圧縮破断によるすべり機能喪失・回着	【支持機能評価】 支圧応力		ピストン	圧縮破断によるすべり機能喪失・回着	【支持機能評価】 曲げ応力		理念	圧縮破断によるすべり機能喪失・回着	【支持機能評価】 支圧応力		突出部	破断によるすべり機能喪失・回着	【支持機能評価】 せん断応力 曲げ応力 支圧応力		ベース ジョット	破断によるすべり機能喪失・回着	【支持機能評価】 支圧応力		支圧部	圧縮破断によるすべり機能喪失・回着	【支持機能評価】 支圧応力		レール	破断によるすべり機能喪失・回着	【支持機能評価】 引張応力 せん断応力	竜巻の風圧力による荷重及び設計乗乗物による衝撃荷重に対し、支持機能を維持するため、作用する応力が許容応力状態N/Sの許容応力を超えないことを確認する	レール取付ボルト エンドプレート 接合ボルト 上部接合ボルト 下部接合ボルト	破断によるすべり機能喪失・回着	【支持機能評価】 引張応力 せん断応力		ベースプレート	破断による隣のフレームへの衝突	【支持機能評価】 曲げ応力 せん断応力		<table border="1"> <thead> <tr> <th>評価対象</th> <th>作用原状</th> <th>損傷モード</th> <th>評価項目</th> <th>構造強度上の評価方針</th> <th>ゴム支承、可動支承採用による設計上の配慮又は対策</th> </tr> </thead> <tbody> <tr> <td rowspan="10">可動支承</td> <td rowspan="10">新巻荷重 竜巻荷重 ネット自重 フレーム荷重 自重</td> <td>ソーラープレート</td> <td>破断によるすべり機能喪失・回着 破断による隣のフレームへの衝突</td> <td>【支持機能評価】 支圧応力</td> <td>竜巻の風圧力による荷重及び設計乗乗物による衝撃荷重に対し、支持機能を維持するため、作用する応力が許容応力状態N/Sの許容応力を超えないことを確認する</td> </tr> <tr> <td>すべり材</td> <td>圧縮破断によるすべり機能喪失・回着</td> <td>【支持機能評価】 支圧応力</td> <td>竜巻の風圧力による荷重及び設計乗乗物による衝撃荷重に対し、支持機能を維持するため、作用する応力がマーガラーの許容応力を超えないことを確認する</td> </tr> <tr> <td>圧縮ゴム</td> <td>圧縮破断によるすべり機能喪失・回着</td> <td>【支持機能評価】 支圧応力</td> <td></td> </tr> <tr> <td>ピストン</td> <td>圧縮破断によるすべり機能喪失・回着</td> <td>【支持機能評価】 曲げ応力</td> <td></td> </tr> <tr> <td>理念</td> <td>圧縮破断によるすべり機能喪失・回着</td> <td>【支持機能評価】 支圧応力</td> <td></td> </tr> <tr> <td>突出部</td> <td>破断によるすべり機能喪失・回着</td> <td>【支持機能評価】 せん断応力 曲げ応力 支圧応力</td> <td></td> </tr> <tr> <td>ベース ジョット</td> <td>破断によるすべり機能喪失・回着</td> <td>【支持機能評価】 支圧応力</td> <td></td> </tr> <tr> <td>支圧部</td> <td>圧縮破断によるすべり機能喪失・回着</td> <td>【支持機能評価】 支圧応力</td> <td></td> </tr> <tr> <td>レール</td> <td>破断によるすべり機能喪失・回着</td> <td>【支持機能評価】 引張応力 せん断応力</td> <td>竜巻の風圧力による荷重及び設計乗乗物による衝撃荷重に対し、支持機能を維持するため、作用する応力が許容応力状態N/Sの許容応力を超えないことを確認する</td> </tr> <tr> <td>レール取付ボルト エンドプレート 接合ボルト 上部接合ボルト 下部接合ボルト</td> <td>破断によるすべり機能喪失・回着</td> <td>【支持機能評価】 引張応力 せん断応力</td> <td></td> </tr> <tr> <td>ベースプレート</td> <td>破断による隣のフレームへの衝突</td> <td>【支持機能評価】 曲げ応力 せん断応力</td> <td></td> </tr> </tbody> </table>	評価対象	作用原状	損傷モード	評価項目	構造強度上の評価方針	ゴム支承、可動支承採用による設計上の配慮又は対策	可動支承	新巻荷重 竜巻荷重 ネット自重 フレーム荷重 自重	ソーラープレート	破断によるすべり機能喪失・回着 破断による隣のフレームへの衝突	【支持機能評価】 支圧応力	竜巻の風圧力による荷重及び設計乗乗物による衝撃荷重に対し、支持機能を維持するため、作用する応力が許容応力状態N/Sの許容応力を超えないことを確認する	すべり材	圧縮破断によるすべり機能喪失・回着	【支持機能評価】 支圧応力	竜巻の風圧力による荷重及び設計乗乗物による衝撃荷重に対し、支持機能を維持するため、作用する応力がマーガラーの許容応力を超えないことを確認する	圧縮ゴム	圧縮破断によるすべり機能喪失・回着	【支持機能評価】 支圧応力		ピストン	圧縮破断によるすべり機能喪失・回着	【支持機能評価】 曲げ応力		理念	圧縮破断によるすべり機能喪失・回着	【支持機能評価】 支圧応力		突出部	破断によるすべり機能喪失・回着	【支持機能評価】 せん断応力 曲げ応力 支圧応力		ベース ジョット	破断によるすべり機能喪失・回着	【支持機能評価】 支圧応力		支圧部	圧縮破断によるすべり機能喪失・回着	【支持機能評価】 支圧応力		レール	破断によるすべり機能喪失・回着	【支持機能評価】 引張応力 せん断応力	竜巻の風圧力による荷重及び設計乗乗物による衝撃荷重に対し、支持機能を維持するため、作用する応力が許容応力状態N/Sの許容応力を超えないことを確認する	レール取付ボルト エンドプレート 接合ボルト 上部接合ボルト 下部接合ボルト	破断によるすべり機能喪失・回着	【支持機能評価】 引張応力 せん断応力		ベースプレート	破断による隣のフレームへの衝突	【支持機能評価】 曲げ応力 せん断応力		<p>【女川】</p> <ul style="list-style-type: none"> ・竜巻防護設備の構造の相違。 ・女川は竜巻防護ネットを設置する海水ポンプエリアの壁が薄く支持機能に期待できないため、可動支承、ゴム支承を採用して地震により生じる応力を低減・分散させる構造として、ネットの支持機能を確保している。 ・泊においては、女川と異なり竜巻防護ネットは強固な建屋床面、ブラケットを介してピット壁面に設置できる環境であることから、女川の竜巻防護ネットの可動支承のような可動式の機構を持たせる必要はない。 ・以上の理由から、泊の竜巻防護ネットは、先行プラント（大飯、高浜）と同様の竜巻防護ネットの構造を採用しており、架構に直接、竜巻防護ネットを設置する構造としている。 	<p>【女川】</p> <ul style="list-style-type: none"> ・竜巻防護設備の構造の相違。 ・女川は竜巻防護ネットを設置する海水ポンプエリアの壁が薄く支持機能に期待できないため、可動支承、ゴム支承を採用して地震により生じる応力を低減・分散させる構造として、ネットの支持機能を確保している。 ・泊においては、女川と異なり竜巻防護ネットは強固な建屋床面、ブラケットを介してピット壁面に設置できる環境であることから、女川の竜巻防護ネットの可動支承のような可動式の機構を持たせる必要はない。 ・以上の理由から、泊の竜巻防護ネットは、先行プラント（大飯、高浜）と同様の竜巻防護ネットの構造を採用しており、架構に直接、竜巻防護ネットを設置する構造としている。
評価対象	作用原状	損傷モード	評価項目	構造強度上の評価方針	ゴム支承、可動支承採用による設計上の配慮又は対策																																																																																																						
可動支承	新巻荷重 竜巻荷重 ネット自重 フレーム荷重 自重	ソーラープレート	破断によるすべり機能喪失・回着 破断による隣のフレームへの衝突	【支持機能評価】 支圧応力	竜巻の風圧力による荷重及び設計乗乗物による衝撃荷重に対し、支持機能を維持するため、作用する応力が許容応力状態N/Sの許容応力を超えないことを確認する																																																																																																						
		すべり材	圧縮破断によるすべり機能喪失・回着	【支持機能評価】 支圧応力	竜巻の風圧力による荷重及び設計乗乗物による衝撃荷重に対し、支持機能を維持するため、作用する応力がマーガラーの許容応力を超えないことを確認する																																																																																																						
		圧縮ゴム	圧縮破断によるすべり機能喪失・回着	【支持機能評価】 支圧応力																																																																																																							
		ピストン	圧縮破断によるすべり機能喪失・回着	【支持機能評価】 曲げ応力																																																																																																							
		理念	圧縮破断によるすべり機能喪失・回着	【支持機能評価】 支圧応力																																																																																																							
		突出部	破断によるすべり機能喪失・回着	【支持機能評価】 せん断応力 曲げ応力 支圧応力																																																																																																							
		ベース ジョット	破断によるすべり機能喪失・回着	【支持機能評価】 支圧応力																																																																																																							
		支圧部	圧縮破断によるすべり機能喪失・回着	【支持機能評価】 支圧応力																																																																																																							
		レール	破断によるすべり機能喪失・回着	【支持機能評価】 引張応力 せん断応力	竜巻の風圧力による荷重及び設計乗乗物による衝撃荷重に対し、支持機能を維持するため、作用する応力が許容応力状態N/Sの許容応力を超えないことを確認する																																																																																																						
		レール取付ボルト エンドプレート 接合ボルト 上部接合ボルト 下部接合ボルト	破断によるすべり機能喪失・回着	【支持機能評価】 引張応力 せん断応力																																																																																																							
ベースプレート	破断による隣のフレームへの衝突	【支持機能評価】 曲げ応力 せん断応力																																																																																																									
評価対象	作用原状	損傷モード	評価項目	構造強度上の評価方針	ゴム支承、可動支承採用による設計上の配慮又は対策																																																																																																						
可動支承	新巻荷重 竜巻荷重 ネット自重 フレーム荷重 自重	ソーラープレート	破断によるすべり機能喪失・回着 破断による隣のフレームへの衝突	【支持機能評価】 支圧応力	竜巻の風圧力による荷重及び設計乗乗物による衝撃荷重に対し、支持機能を維持するため、作用する応力が許容応力状態N/Sの許容応力を超えないことを確認する																																																																																																						
		すべり材	圧縮破断によるすべり機能喪失・回着	【支持機能評価】 支圧応力	竜巻の風圧力による荷重及び設計乗乗物による衝撃荷重に対し、支持機能を維持するため、作用する応力がマーガラーの許容応力を超えないことを確認する																																																																																																						
		圧縮ゴム	圧縮破断によるすべり機能喪失・回着	【支持機能評価】 支圧応力																																																																																																							
		ピストン	圧縮破断によるすべり機能喪失・回着	【支持機能評価】 曲げ応力																																																																																																							
		理念	圧縮破断によるすべり機能喪失・回着	【支持機能評価】 支圧応力																																																																																																							
		突出部	破断によるすべり機能喪失・回着	【支持機能評価】 せん断応力 曲げ応力 支圧応力																																																																																																							
		ベース ジョット	破断によるすべり機能喪失・回着	【支持機能評価】 支圧応力																																																																																																							
		支圧部	圧縮破断によるすべり機能喪失・回着	【支持機能評価】 支圧応力																																																																																																							
		レール	破断によるすべり機能喪失・回着	【支持機能評価】 引張応力 せん断応力	竜巻の風圧力による荷重及び設計乗乗物による衝撃荷重に対し、支持機能を維持するため、作用する応力が許容応力状態N/Sの許容応力を超えないことを確認する																																																																																																						
		レール取付ボルト エンドプレート 接合ボルト 上部接合ボルト 下部接合ボルト	破断によるすべり機能喪失・回着	【支持機能評価】 引張応力 せん断応力																																																																																																							
ベースプレート	破断による隣のフレームへの衝突	【支持機能評価】 曲げ応力 せん断応力																																																																																																									

赤字：設備、運用又は体制の相違（設計方針の相違）
 青字：記載箇所又は記載内容の相違（記載方針の相違）
 緑字：記載表現、設備名称の相違（実質的な相違なし）

大飯発電所3/4号炉

女川原子力発電所2号炉

泊発電所3号炉

相違理由

表10 竜巻防護ネットの損傷モード整理表 (6/6)

評価対象	作用荷重	損傷モード	評価項目	構造強度上の評価方針	ゴム支承、可動支承採用による設計上の配慮又は対策
ブラケット本体	衝撃荷重 竜巻風荷重 ネット荷重 フレーム荷重 大梁荷重 自重	破断による大梁の落下	【支持機能評価】 せん断応力 曲げ応力 引張応力	竜巻の風圧力による荷重及び設計飛来物による衝撃荷重に対し、上載するフレーム等を支持する構造強度を維持するため、作用する応力が許容応力状態V ₀ の許容応力を超えないことを確認する	ゴム支承、可動支承採用による設計上の配慮又は対策 (1) 衝撃荷重に対するゴム支承・可動支承の影響に配慮する必要がある
ブラケットアンカーボルト					

(比較のため再掲)

表8 竜巻防護ネットの損傷モード整理表 (2/2)

評価対象	作用荷重	損傷モード	評価項目	構造強度上の評価方針
すり抜け防止用鋼材	衝撃荷重 竜巻風荷重 自重	防護板を貫通することにより設計飛来物の防護対象施設への衝突	【貫通評価】 ひずみ量	衝突箇所が発生する衝撃荷重によって貫通が生じないように、終局状態に至るようひずみを生じないことを確認する
架台	衝撃荷重 竜巻風荷重 ネット荷重	架台を貫通することにより設計飛来物の防護対象施設への衝突	【貫通評価】 ひずみ量	設計飛来物が支持部材に衝突した場合に、衝突箇所が発生する衝撃荷重によって貫通が生じないように、架台の鋼材が終局状態に至るようひずみを生じないことを確認する
		架台に設計飛来物が衝突することによって、破断・落下し防護対象施設に衝突	【支持機能評価】 ひずみ量	竜巻の風圧力による荷重及び設計飛来物による衝撃荷重に対し、上載するネットを支持するため、架台の鋼材が終局状態に至るようひずみを生じないことを確認する
ブラケット アンカーボルト	衝撃荷重 竜巻風荷重 ネット荷重 架台荷重 自重	破断による架台の落下	【支持機能評価】 せん断応力 曲げ応力 引張応力	竜巻の風圧力による荷重及び設計飛来物による衝撃荷重に対し、上載するネットを支持するため、ブラケットの鋼材が終局状態に至るようひずみを生じないことを確認する

【女川】
 ・竜巻防護設備の構造の相違。
 ・女川は竜巻防護ネットを設置する海水ポンプエリアの壁が薄く支持機能に期待できないため、可動支承、ゴム支承を採用して地震により生じる応力を低減・分散させる構造として、ネットの支持機能を確保している。
 ・泊においては、女川と異なり竜巻防護ネットは強固な建屋床面、ブラケットを介してピット壁面に設置できる環境であることから、女川の竜巻防護ネットの可動支承のような可動式の機構を持たせる必要はない。
 ・以上の理由から、泊の竜巻防護ネットは、先行プラント（大飯、高浜）と同様の竜巻防護ネットの構造を採用しており、架構に直接、竜巻防護ネットを設置する構造としている。

【女川】
 記載表現の相違（表番号）

赤字：設備、運用又は体制の相違（設計方針の相違）
 青字：記載箇所又は記載内容の相違（記載方針の相違）
 緑字：記載表現、設備名称の相違（実質的な相違なし）

大飯発電所3/4号炉	女川原子力発電所2号炉	泊発電所3号炉	相違理由																																												
	<p>3.8.2 設計上の配慮又は対策が必要となる事項</p> <p>竜巻防護ネットの各構造について、ゴム支承、可動支承の採用による設計上の配慮又は対策が必要な事項を表11にまとめる。</p> <div data-bbox="712 264 1326 683" style="border: 1px solid black; padding: 5px;"> <p>表11 ゴム支承、可動支承の採用による設計上の配慮又は対策が必要な事項</p> <table border="1" style="width: 100%; border-collapse: collapse; text-align: center;"> <thead> <tr> <th rowspan="2">評価部位</th> <th colspan="4">設計上の配慮又は対策が必要な事項</th> </tr> <tr> <th>(1) 衝撃荷重に対するゴム支承・可動支承の影響</th> <th>(2) ストッパーの設置</th> <th>(3) 作用荷重による変位に対する影響</th> <th>(4) 作用荷重により発生する振動の影響</th> </tr> </thead> <tbody> <tr> <td>ネット（金網部）</td> <td>○</td> <td>—</td> <td>—</td> <td>—</td> </tr> <tr> <td>防護板</td> <td>○</td> <td>—</td> <td>○</td> <td>—</td> </tr> <tr> <td>フレーム</td> <td>○</td> <td>○</td> <td>○</td> <td>○</td> </tr> <tr> <td>大梁</td> <td>○</td> <td>—</td> <td>○</td> <td>—</td> </tr> <tr> <td>ゴム支承</td> <td>○</td> <td>—</td> <td>○</td> <td>—</td> </tr> <tr> <td>可動支承</td> <td>○</td> <td>—</td> <td>○</td> <td>—</td> </tr> <tr> <td>ブラケット</td> <td>○</td> <td>—</td> <td>—</td> <td>—</td> </tr> </tbody> </table> <p style="font-size: small;">凡例 ○：配慮又は対策が必要 —：対応不要</p> </div> <p>3.8.3 設計上の配慮又は対策が必要となる事項に対する対応</p> <p>「3.8.2 設計上の配慮又は対策が必要となる事項」で抽出された事項について、適切に設計に反映することで、竜巻防護ネットにより非常用海水ポンプ等を設計飛来物の衝突から防護し、安全機能が損なわれない設計とする。設計上の配慮又は対策が必要な事項に対する対応方針について、(1)～(4)に示す。</p> <p>(1) 衝撃荷重に対するゴム支承・可動支承の影響</p> <p>衝撃荷重に対するゴム支承や可動支承の影響は、地震時における部材の特性（役割・挙動）から、飛来物の衝突時において以下の影響が考えられる。</p> <p>a. 飛来物の衝突におけるゴム支承の変形等の影響</p> <p>飛来物が部材に衝突した場合には、伝達された荷重によってゴム支承が変形、可動支承が1軸方向にすべることにより、他の部材と干渉する可能性がある。</p> <p>b. 飛来物の衝突における部材間の荷重の伝達</p> <p>飛来物が部材に衝突した場合に、ゴム支承に荷重が伝達されるが、ゴム支承が変形することにより、荷重が低減される可能性がある。</p> <p>これらの影響を踏まえて、構造成立性の見直しを確認するために、竜巻防護ネットを構成する支持部材に対し、代表的な飛来物衝突の解析評価を実施する。評価は以下の2ステップで実施する。各STEPの評価フローを図14に示す。また、支持部材の評価方法については別紙2に整理する。</p>	評価部位	設計上の配慮又は対策が必要な事項				(1) 衝撃荷重に対するゴム支承・可動支承の影響	(2) ストッパーの設置	(3) 作用荷重による変位に対する影響	(4) 作用荷重により発生する振動の影響	ネット（金網部）	○	—	—	—	防護板	○	—	○	—	フレーム	○	○	○	○	大梁	○	—	○	—	ゴム支承	○	—	○	—	可動支承	○	—	○	—	ブラケット	○	—	—	—		<p>【女川】</p> <ul style="list-style-type: none"> ・竜巻防護設備の構造の相違。 ・女川は竜巻防護ネットを設置する海水ポンプエリアの壁が薄く支持機能に期待できないため、可動支承、ゴム支承を採用して地震により生じる応力を低減・分散させる構造として、ネットの支持機能を確保している。 ・泊においては、女川と異なり竜巻防護ネットは強固な建屋床面、ブラケットを介してピット壁面に設置できる環境であることから、女川の竜巻防護ネットの可動支承のような可動式の機構を持たせる必要はない。 ・以上の理由から、泊の竜巻防護ネットは、先行プラント（大飯、高浜）と同様の竜巻防護ネットの構造を採用しており、架構に直接、竜巻防護ネットを設置する構造としている。
評価部位	設計上の配慮又は対策が必要な事項																																														
	(1) 衝撃荷重に対するゴム支承・可動支承の影響	(2) ストッパーの設置	(3) 作用荷重による変位に対する影響	(4) 作用荷重により発生する振動の影響																																											
ネット（金網部）	○	—	—	—																																											
防護板	○	—	○	—																																											
フレーム	○	○	○	○																																											
大梁	○	—	○	—																																											
ゴム支承	○	—	○	—																																											
可動支承	○	—	○	—																																											
ブラケット	○	—	—	—																																											

赤字：設備、運用又は体制の相違（設計方針の相違）
 青字：記載箇所又は記載内容の相違（記載方針の相違）
 緑字：記載表現、設備名称の相違（実質的な相違なし）

大飯発電所3/4号炉	女川原子力発電所2号炉	泊発電所3号炉	相違理由
	<p>【STEP1】 ゴム支承に支持されるフレームに飛来物が衝突した際の挙動を確認するため、ゴム支承の剛性を考慮した衝突解析を実施する。衝突解析は、フレームゴム支承による影響が最も大きくなると想定される条件（飛来物姿勢、衝突位置、飛来方向）で実施し、ゴム支承の影響を考慮した場合において、フレームゴム支承、可動支承がフレームを支持する機能を維持可能な構造強度を有することを確認する。STEP1の評価結果について別紙3に整理する。</p> <p>【STEP2】 衝突時の竜巻防護ネットを構成する支持部材の構造成立性を確認するため、以下の評価を実施する。STEP2の評価結果については別紙4に整理する。 STEP2-1：竜巻防護ネットを構成する支持部材（ストッパーを除く）はゴム剛性の結合条件を3方向固定（衝撃荷重のピーク値が大きくなると推測される条件）にて衝突解析を行い、構造成立性の確認を行う。 STEP2-2：STEP2-1はフレームゴム支承に対し非常に厳しい条件であるため、STEP2-1の条件で評価を実施した結果、許容値を満足しない場合には、詳細評価としてゴム支承のせん断剛性を考慮した解析条件にて評価を実施する。 STEP2-3：STEP2-2のフレームゴム支承の評価結果を踏まえて、ストッパーの評価を実施する。ストッパーの評価はゴム剛性の結合条件を自由（ゴム支承による荷重の負担は期待せずストッパーに全ての荷重を伝達する条件）とし衝突解析を行い、構造成立性の確認を行う。</p>		<p>【女川】</p> <ul style="list-style-type: none"> ・竜巻防護設備の構造の相違。 ・女川は竜巻防護ネットを設置する海水ポンプエリアの壁が薄く支持機能に期待できないため、可動支承、ゴム支承を採用して地震により生じる応力を低減・分散させる構造として、ネットの支持機能を確保している。 ・泊においては、女川と異なり竜巻防護ネットは強固な建屋床面、ブラケットを介してビット壁面に設置できる環境であることから、女川の竜巻防護ネットの可動支承のような可動式の機構を持たせる必要はない。 ・以上の理由から、泊の竜巻防護ネットは、先行プラント（大飯、高浜）と同様の竜巻防護ネットの構造を採用しており、架構に直接、竜巻防護ネットを設置する構造としている。

赤字：設備、運用又は体制の相違（設計方針の相違）
 青字：記載箇所又は記載内容の相違（記載方針の相違）
 緑字：記載表現、設備名称の相違（実質的な相違なし）

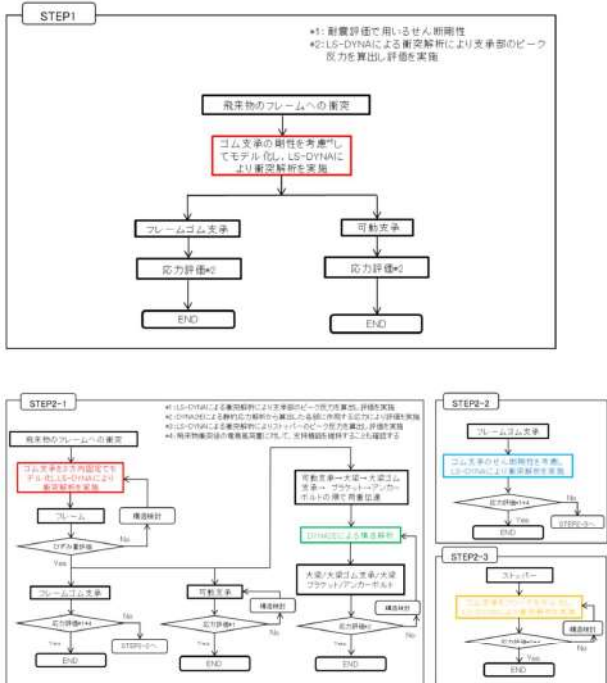
大飯発電所3/4号炉	女川原子力発電所2号炉	泊発電所3号炉	相違理由
	 <p>図14 STEP1, STEP2 評価フロー</p> <p>応力等の算出方法について図15に示す。 衝突解析はLS-DYNAを使用し、モデル化の対象は飛来物が衝突するフレームとする。フレームゴム支承、可動支承は各STEPにおいて設定した結合条件を設定する。LS-DYNAにより衝突部であるフレームのひずみ評価を実施するとともに、支承部のピーク反力を算出し、フレームゴム支承及び可動支承の評価を実施する。（自重及び竜巻による風荷重についても反力として考慮する） 可動支承に発生した荷重は大梁、大梁ゴム支承、ブラケット、ブラケットアンカーボルトに伝達されるため、LS-DYNAにより算出した可動支承に作用するピーク反力を解析モデル（耐震評価と同様のモデル：DYNA2E）に入力し、各部に作用する応力を算出する。</p>		<p>【女川】</p> <ul style="list-style-type: none"> ・竜巻防護設備の構造の相違。 ・女川は竜巻防護ネットを設置する海水ポンプエリアの壁が薄く支持機能に期待できないため、可動支承、ゴム支承を採用して地震により生じる応力を低減・分散させる構造として、ネットの支持機能を確保している。 ・泊においては、女川と異なり竜巻防護ネットは強固な建屋床面、ブラケットを介してピット壁面に設置できる環境であることから、女川の竜巻防護ネットの可動支承のような可動式の機構を持たせる必要はない。 ・以上の理由から、泊の竜巻防護ネットは、先行プラント（大飯、高浜）と同様の竜巻防護ネットの構造を採用しており、架構に直接、竜巻防護ネットを設置する構造としている。

赤字：設備、運用又は体制の相違（設計方針の相違）
 青字：記載箇所又は記載内容の相違（記載方針の相違）
 緑字：記載表現、設備名称の相違（実質的な相違なし）

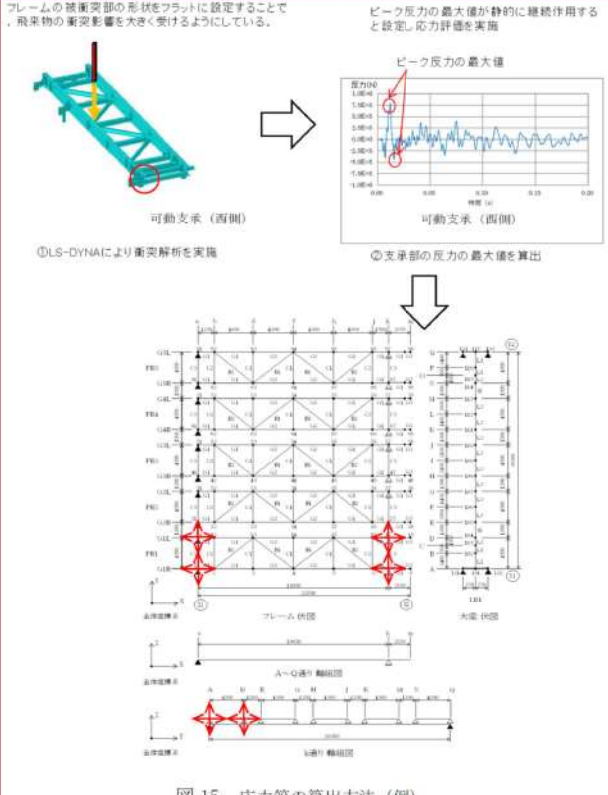
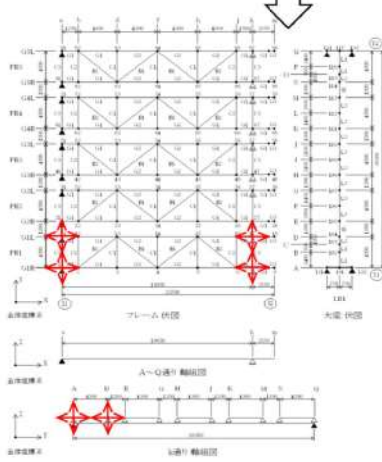
大飯発電所3/4号炉	女川原子力発電所2号炉	泊発電所3号炉	相違理由
	<p data-bbox="719 156 1008 188">フレームの接合部の形状をフラットに設定することで、飛来物の衝突影響を大きく受けるようにしている。</p>  <p data-bbox="745 402 931 418">①LS-DYNAにより衝突解析を実施</p> <p data-bbox="1077 402 1254 418">②支承部の反力の最大値を算出</p>  <p data-bbox="887 948 1128 963">図15 応力等の算出方法（例）</p> <p data-bbox="712 1015 1317 1062">表12～15に、衝突解析における各STEPごとのフレームゴム支承、可動支承の結合条件を整理する。</p> <p data-bbox="712 1075 1323 1267">STEP2-1は、下部構造に対し支承部の荷重がそのまま伝達される条件で評価を実施し、ゴム支承における荷重の低減・分散効果を期待しない衝突解析となるため、これまでの他プラントでの適用実績がある竜巻防護ネットの衝突解析と同等の条件となる。また、ネット（金網部）の電中研報告による評価及び防護板のBRL式による評価手法は、STEP2-1の条件で適用が可能である。よって、STEP2-1の条件は、ストッパーを除く部材に適用する。</p> <p data-bbox="712 1279 1317 1327">STEP2-2の条件は、STEP2-1でフレームゴム支承が許容値を満足しない場合のフレームゴム支承評価に適用する。</p> <p data-bbox="712 1340 1323 1388">STEP2-3は、STEP2-2でフレームゴム支承が許容値を満足しない場合のストッパー評価に適用する。</p>		<p data-bbox="1980 143 2038 159">【女川】</p> <ul style="list-style-type: none"> <li data-bbox="1980 172 2145 220">・竜巻防護設備の構造の相違。 <li data-bbox="1980 233 2145 510">・女川は竜巻防護ネットを設置する海水ポンプエリアの壁が薄く支持機能に期待できないため、可動支承、ゴム支承を採用して地震により生じる応力を低減・分散させる構造として、ネットの支持機能を確保している。 <li data-bbox="1980 523 2145 801">・泊においては、女川と異なり竜巻防護ネットは強固な建屋床面、ブラケットを介してビット壁面に設置できる環境であることから、女川の竜巻防護ネットの可動支承のような可動式の機構を持たせる必要はない。 <li data-bbox="1980 813 2145 1062">・以上の理由から、泊の竜巻防護ネットは、先行プラント（大飯、高浜）と同様の竜巻防護ネットの構造を採用しており、架構に直接、竜巻防護ネットを設置する構造としている。

赤字：設備、運用又は体制の相違（設計方針の相違）
 青字：記載箇所又は記載内容の相違（記載方針の相違）
 緑字：記載表現、設備名称の相違（実質的な相違なし）

大飯発電所3/4号炉	女川原子力発電所2号炉	泊発電所3号炉	相違理由																																																
	<p>表12 【STEP1】衝突解析におけるゴム支承、可動支承の結合条件</p> <table border="1" data-bbox="824 177 1216 323"> <thead> <tr> <th>方向</th> <th>フレーム ゴム支承</th> <th>可動支承</th> </tr> </thead> <tbody> <tr> <td>X</td> <td>弾性</td> <td>自由</td> </tr> <tr> <td>Y</td> <td>弾性</td> <td>剛</td> </tr> <tr> <td>Z</td> <td>剛</td> <td>剛</td> </tr> </tbody> </table> <p>表13 【STEP2-1】衝突解析におけるゴム支承、可動支承の結合条件</p> <table border="1" data-bbox="824 411 1216 558"> <thead> <tr> <th>方向</th> <th>フレーム ゴム支承</th> <th>可動支承</th> </tr> </thead> <tbody> <tr> <td>X</td> <td>剛</td> <td>自由</td> </tr> <tr> <td>Y</td> <td>剛</td> <td>剛</td> </tr> <tr> <td>Z</td> <td>剛</td> <td>剛</td> </tr> </tbody> </table> <p>表14 【STEP2-2】衝突解析におけるゴム支承、可動支承の結合条件</p> <table border="1" data-bbox="824 646 1216 793"> <thead> <tr> <th>方向</th> <th>フレーム ゴム支承</th> <th>可動支承</th> </tr> </thead> <tbody> <tr> <td>X</td> <td>弾性</td> <td>自由</td> </tr> <tr> <td>Y</td> <td>弾性</td> <td>剛</td> </tr> <tr> <td>Z</td> <td>剛</td> <td>剛</td> </tr> </tbody> </table> <p>表15 【STEP2-3】衝突解析におけるゴム支承、可動支承結合条件</p> <table border="1" data-bbox="824 880 1216 1027"> <thead> <tr> <th>方向</th> <th>フレーム ゴム支承</th> <th>可動支承</th> </tr> </thead> <tbody> <tr> <td>X</td> <td>自由</td> <td>自由</td> </tr> <tr> <td>Y</td> <td>自由</td> <td>剛</td> </tr> <tr> <td>Z</td> <td>自由</td> <td>剛</td> </tr> </tbody> </table> <p>(2)ストッパーの設置 ストッパーはSTEP2-2の評価結果（別紙4参照）において、許容値を満足しない場合に、支持機能としての役割が必要となるものである。 ストッパーの設計は、STEP2-3の解析条件にて実施し、ストッパーはゴム支承による荷重の負担を期待せず全ての荷重を伝達する条件で、衝撃荷重に対し許容応力を満足し、竜巻防護ネットを支持する構造強度を有する設計とする。 ストッパーの設置イメージを図16に示す。</p>	方向	フレーム ゴム支承	可動支承	X	弾性	自由	Y	弾性	剛	Z	剛	剛	方向	フレーム ゴム支承	可動支承	X	剛	自由	Y	剛	剛	Z	剛	剛	方向	フレーム ゴム支承	可動支承	X	弾性	自由	Y	弾性	剛	Z	剛	剛	方向	フレーム ゴム支承	可動支承	X	自由	自由	Y	自由	剛	Z	自由	剛		<p>【女川】</p> <ul style="list-style-type: none"> ・竜巻防護設備の構造の相違。 ・女川は竜巻防護ネットを設置する海水ポンプエリアの壁が薄く支持機能に期待できないため、可動支承、ゴム支承を採用して地震により生じる応力を低減・分散させる構造として、ネットの支持機能を確保している。 ・泊においては、女川と異なり竜巻防護ネットは強固な建屋床面、ブラケットを介してビット壁面に設置できる環境であることから、女川の竜巻防護ネットの可動支承のような可動式の機構を持たせる必要はない。 ・以上の理由から、泊の竜巻防護ネットは、先行プラント（大飯、高浜）と同様の竜巻防護ネットの構造を採用しており、架構に直接、竜巻防護ネットを設置する構造としている。
方向	フレーム ゴム支承	可動支承																																																	
X	弾性	自由																																																	
Y	弾性	剛																																																	
Z	剛	剛																																																	
方向	フレーム ゴム支承	可動支承																																																	
X	剛	自由																																																	
Y	剛	剛																																																	
Z	剛	剛																																																	
方向	フレーム ゴム支承	可動支承																																																	
X	弾性	自由																																																	
Y	弾性	剛																																																	
Z	剛	剛																																																	
方向	フレーム ゴム支承	可動支承																																																	
X	自由	自由																																																	
Y	自由	剛																																																	
Z	自由	剛																																																	

赤字：設備、運用又は体制の相違（設計方針の相違）
 青字：記載箇所又は記載内容の相違（記載方針の相違）
 緑字：記載表現、設備名称の相違（実質的な相違なし）

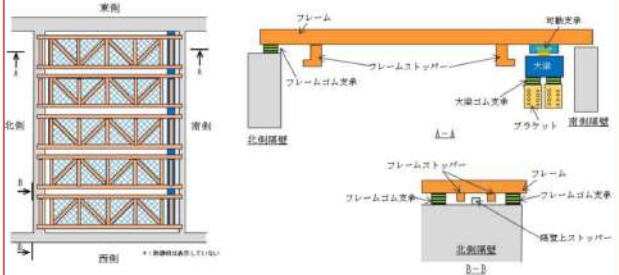
大飯発電所3/4号炉	女川原子力発電所2号炉	泊発電所3号炉	相違理由
	 <p>(3) 作用荷重によるフレームの変位に対する影響 ゴム支承、可動支承に支持されているフレーム及びゴム支承に支持されている大梁は、設計竜巻による風荷重や地震によって水平方向の変位が生じることから、他の設備との干渉について考慮する必要がある。 そのため、フレーム間や大梁と海水ポンプ室補機ポンプエリア壁面との間等に、設計竜巻による風荷重や地震により発生する変位を踏まえてクリアランスを確保する設計とする。 地震力による水平方向の変位についての評価は、設置許可基準規則第4条に対する適合状況説明資料『設計基準対象施設について（第4条地震による損傷の防止）』で説明する。なお、風圧力による水平方向の変位については、地震力による水平方向の変位に包絡される。 また、フレーム間及びフレームと海水ポンプ室補機ポンプエリア壁面にクリアランスを確保していることから、これらの隙間から設計飛来物の侵入を防ぐために、フレームに防護板を設置する。 防護板はフレームの水平変位を考慮した上で、ラビリンス構造とすることで、設計飛来物である銅製材（縦4.2m×横0.3m×高さ0.2m）が通過しない構造とする。</p> <p>(4) 振動による影響 竜巻防護ネットに飛来物衝突した際に振動が発生するが、飛来物衝突による振動は一時的なものであり、共振が発生して構造健全性に影響を与える可能性は低い。 また、竜巻による風の影響により振動が発生する可能性があるが、共振が発生するには一定の風が吹き続ける必要があることから、竜巻による瞬間的な風に対し、共振が発生する可能性は低い。 一定の風が継続して吹く場合、風による共振が発生する可能性が考えられるため、共振や疲労など風による振動への影響について検討し、必要に応じ、竜巻防護ネットの構造設計に反映する。</p>		<p>【女川】</p> <ul style="list-style-type: none"> ・竜巻防護設備の構造の相違。 ・女川は竜巻防護ネットを設置する海水ポンプエリアの壁が薄く支持機能に期待できないため、可動支承、ゴム支承を採用して地震により生じる応力を低減・分散させる構造として、ネットの支持機能を確保している。 ・泊においては、女川と異なり竜巻防護ネットは強固な建屋床面、ブラケットを介してビット壁面に設置できる環境であることから、女川の竜巻防護ネットの可動支承のような可動式の機構を持たせる必要はない。 ・以上の理由から、泊の竜巻防護ネットは、先行プラント（大飯、高浜）と同様の竜巻防護ネットの構造を採用しており、架構に直接、竜巻防護ネットを設置する構造としている。

赤字：設備、運用又は体制の相違（設計方針の相違）
 青字：記載箇所又は記載内容の相違（記載方針の相違）
 緑字：記載表現、設備名称の相違（実質的な相違なし）

大飯発電所3/4号炉	女川原子力発電所2号炉	泊発電所3号炉	相違理由
	<p>4. 竜巻防護に対する評価方針</p> <p>4.1 強度評価</p> <p>4.1.1 ネット（金網部）</p> <p>ネット（金網部）の強度評価は「3.2.1 荷重条件」で設定した荷重及び荷重の組合せを踏まえて、評価対象部位に作用する応力等について確認するものである。</p> <p>(1) 評価項目</p> <p>設計荷重に対してネットは、設計飛来物を捕捉し非常用海水ポンプ等へ衝突させないために、破断が生じない強度を有すること及びたわみが生じても、設計飛来物が非常用海水ポンプ等と衝突しないよう非常用海水ポンプ等との離隔が確保できることを確認する。</p> <p>破断が生じないことの確認として、ネットが設計飛来物のエネルギーを吸収できること及び設計飛来物の衝突箇所において、ネットの破断が生じない強度を有することを評価する。また、防護ネットが設計飛来物を捕捉可能であることを確認するために、設計荷重に対してネットを支持するワイヤーロープ、ターンバックル、シャックル及び接続用の治具に破断が生じない強度を有することを評価する。</p> <p>設計飛来物の衝突位置の影響として、中央位置からずれたオフセット位置に衝突する場合の影響を考慮する。</p> <p>(2) 評価対象部位</p> <p>ネット（金網部）の強度評価においては、その構造を踏まえて、設計竜巻による荷重とこれに組み合わせる荷重（以下「設計荷重」という。）の作用方向及び伝達過程を考慮し、評価対象部位を設定する。</p> <p>① ネット</p> <p>ネットには設計竜巻荷重が直接作用するため、評価対象部位とする。</p> <p>② ワイヤーロープ、ターンバックル及びシャックル</p> <p>ネットに作用した荷重は、ワイヤーロープを介してターンバックル及びシャックルに作用するため、ワイヤーロープ、ターンバックル及びシャックルを評価対象部位とする。</p> <p>③ 接続用の治具</p> <p>接続用の治具及びワイヤーロープ固定部には、ワイヤーロープを介して伝達された荷重が作用するため、接続用の治具である隅角部固定ボルト、ワイヤーロープ固定部を評価対象部位とする。</p> <p>図17にネット（金網部）の評価対象部位、図18に設計飛来物衝突時の荷重伝達を示す。</p>	<p>4. 竜巻防護に対する評価方針</p> <p>4.1 強度評価</p> <p>4.1.1 ネット（金網部）</p> <p>ネット（金網部）の強度評価は「3.2.1 荷重条件」で設定した荷重及び荷重の組合せを踏まえて、評価対象部位に作用する応力等について確認するものである。</p> <p>(1) 評価項目</p> <p>設計荷重に対してネットは、設計飛来物を捕捉し原子炉補機冷却海水ポンプ等へ衝突させないために、破断が生じない強度を有すること及びたわみが生じても、設計飛来物が原子炉補機冷却海水ポンプ等と衝突しないよう原子炉補機冷却海水ポンプ等との離隔が確保できることを確認する。</p> <p>破断が生じないことの確認として、ネットが設計飛来物のエネルギーを吸収できること及び設計飛来物の衝突箇所において、ネットの破断が生じない強度を有することを評価する。また、防護ネットが設計飛来物を捕捉可能であることを確認するために、設計荷重に対してネットを支持するワイヤロープ、ターンバックル、シャックル及び接続用の治具に破断が生じない強度を有することを評価する。</p> <p>設計飛来物の衝突位置の影響として、中央位置からずれたオフセット位置に衝突する場合の影響を考慮する。</p> <p>(2) 評価対象部位</p> <p>ネット（金網部）の強度評価においては、その構造を踏まえて、設計竜巻による荷重とこれに組み合わせる荷重（以下「設計荷重」という。）の作用方向及び伝達過程を考慮し、評価対象部位を設定する。</p> <p>① ネット</p> <p>ネットには設計竜巻荷重が直接作用するため、評価対象部位とする。</p> <p>② ワイヤロープ、ターンバックル及びシャックル</p> <p>ネットに作用した荷重は、ワイヤロープを介してターンバックル及びシャックルに作用するため、ワイヤロープ、ターンバックル及びシャックルを評価対象部位とする。</p> <p>③ 接続用の治具</p> <p>接続用の治具及びワイヤロープ固定部には、ワイヤロープを介して伝達された荷重が作用するため、接続用の治具である隅角部固定ボルト、ワイヤロープ固定部を評価対象部位とする。</p> <p>図9にネット（金網部）の評価対象部位、図10に設計飛来物衝突時の荷重伝達を示す。</p>	<p>【女川】 竜巻防護ネットで防護する対象機器の相違</p>

赤字：設備、運用又は体制の相違（設計方針の相違）
 青字：記載箇所又は記載内容の相違（記載方針の相違）
 緑字：記載表現、設備名称の相違（実質的な相違なし）

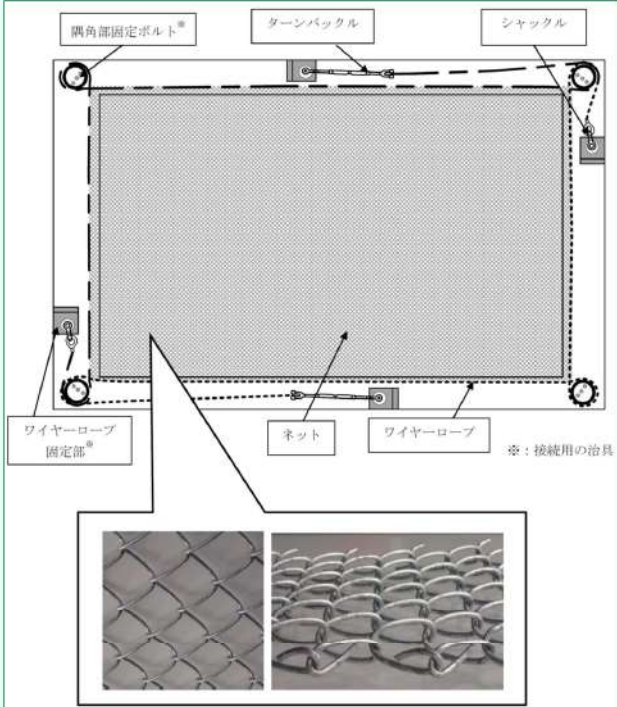
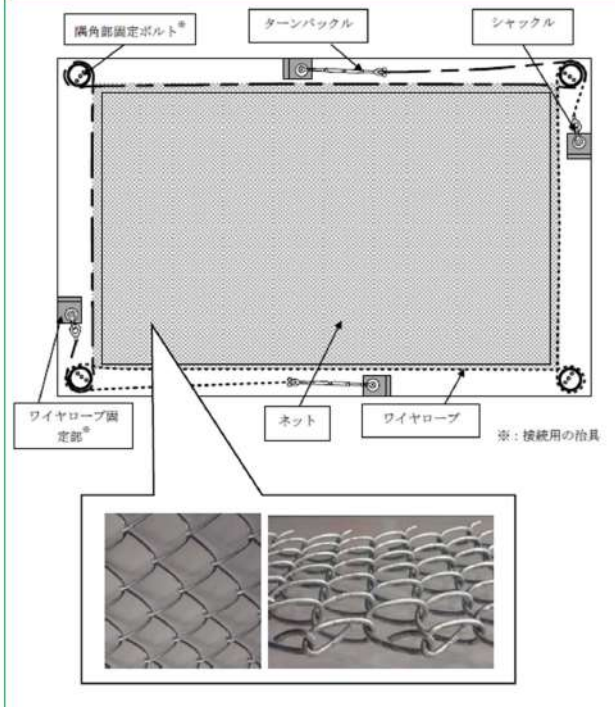
大飯発電所3/4号炉	女川原子力発電所2号炉	泊発電所3号炉	相違理由
	 <p data-bbox="869 909 1169 933">図17 ネット（金網部）の評価対象部位</p>	 <p data-bbox="1500 885 1800 909">図9 ネット（金網部）の評価対象部位</p>	<p data-bbox="1982 143 2094 191">【女川】 記載表現の相違</p> <p data-bbox="1982 869 2150 949">【女川】 記載表現の相違（図番号）</p>

赤字：設備、運用又は体制の相違（設計方針の相違）
 青字：記載箇所又は記載内容の相違（記載方針の相違）
 緑字：記載表現、設備名称の相違（実質的な相違なし）

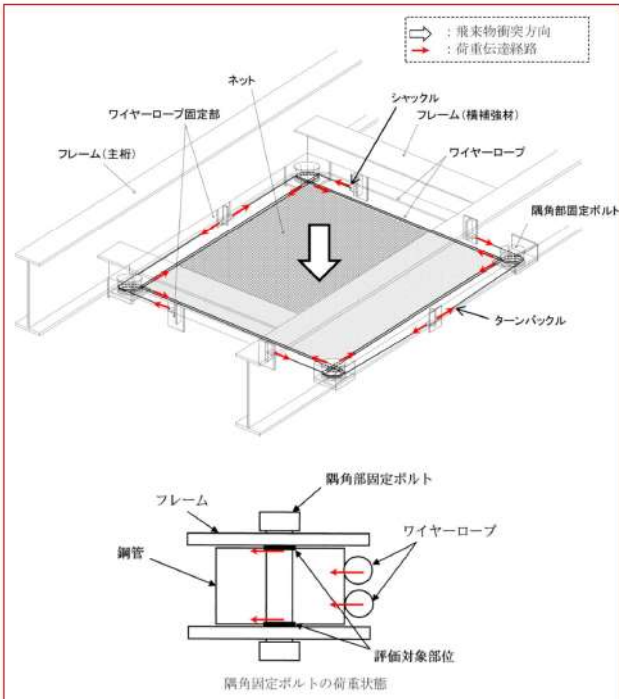
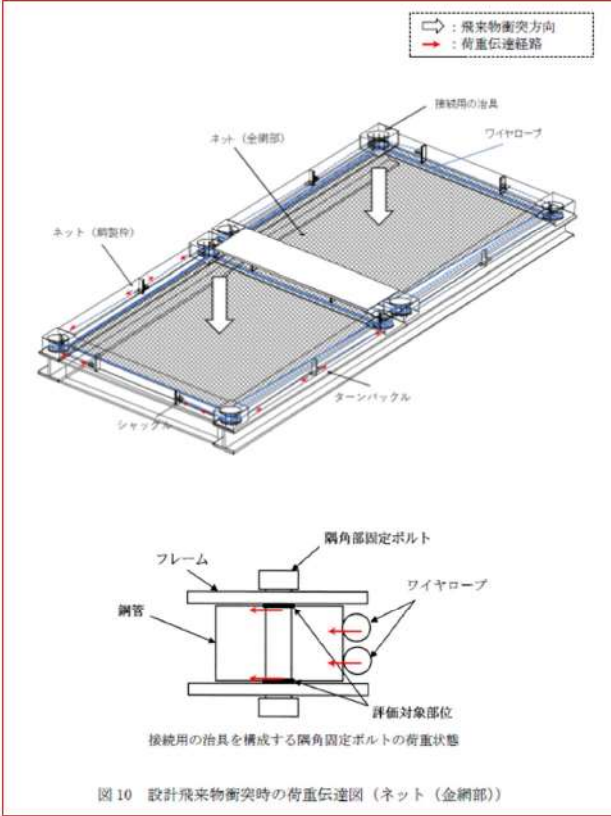
大飯発電所3/4号炉	女川原子力発電所2号炉	泊発電所3号炉	相違理由
	 <p>図18 設計飛来物衝突時の荷重伝達図（ネット（金網部））</p>	 <p>図10 設計飛来物衝突時の荷重伝達図（ネット（金網部））</p>	<p>【女川】 ・プラント設計の相違による設置設備の相違 女川は開口部が泊よりも広いこと等から、竜巻防護ネットの構造が異なる。</p> <p>【女川】 記載表現の相違（図番号）</p> <p>【女川】 女川の別紙5には竜巻防護ネットの構造健全性評価基準について記載されている。当該資料は、ゴム支承、可動支承の評価項目や許容限界等を整理する目的で作成されたと考えている。泊においては、ゴム支承、可動支承を採用していないため、設工認段階で女川の別紙5に対応する内容を記載するため、当該別</p>
<p>(3) 許容限界（詳細は別紙5参照）</p> <p>①吸収エネルギー評価 吸収エネルギー評価においては、計算により算出するネットの限界吸収エネルギーがネットに作用するエネルギー以上であることにより、ネットが破断しないことを確認する。</p> <p>②破断評価 ネット（金網部）の破断評価においては、計算により算出するネットに作用する荷重がネットの素材の持つ破断強度以下であることにより、ネットに破断が生じない強度を有することを確認する。 ワイヤロープは、ネットと一体となって設計飛来物を捕捉するため、ネットと同様に塑性変形を許容することから、破断荷重を許容限界とする。 ターンバックル及びシャックルは、破断しなければネットを設置位置に保持することができ、設計飛来物を捕捉可能である。したがっ</p>	<p>(3) 許容限界</p> <p>①吸収エネルギー評価 吸収エネルギー評価においては、計算により算出するネットの限界吸収エネルギーがネットに作用するエネルギー以上であることにより、ネットが破断しないことを確認する。</p> <p>②破断評価 ネット（金網部）の破断評価においては、計算により算出するネットに作用する荷重がネットの素材の持つ破断強度以下であることにより、ネットに破断が生じない強度を有することを確認する。 ワイヤロープは、ネットと一体となって設計飛来物を捕捉するため、ネットと同様に塑性変形を許容することから、破断荷重を許容限界とする。 ターンバックル及びシャックルは、破断しなければネットを設置位置に保持することができ、設計飛来物を捕捉可能である。したがっ</p>		



赤字：設備、運用又は体制の相違（設計方針の相違）
 青字：記載箇所又は記載内容の相違（記載方針の相違）
 緑字：記載表現、設備名称の相違（実質的な相違なし）

大飯発電所3/4号炉	女川原子力発電所2号炉	泊発電所3号炉	相違理由
<p>て、ワイヤロープの張力に対し、破断しないことを確認する。 接続用の治具の破断評価は、計算により算出する応力により接続用の治具を破断しない強度を許容限界とする。</p> <p>③たわみ評価 竜巻防護ネット本体は、自重、設計竜巻の風圧力による荷重及び設計飛来物による衝撃荷重に対し、計算により算出する竜巻防護ネット本体の最大たわみ量がネットと非常用海水ポンプ等の離隔距離未満であることを確認するため、ネットと非常用海水ポンプ等の最小離隔距離を許容限界として設定する。</p> <p>4.1.2 支持部材（フレーム、大梁、フレームゴム支承、大梁ゴム支承、可動支承、ブラケット、ストッパー） 支持部材（フレーム、大梁、フレームゴム支承、大梁ゴム支承、可動支承、ブラケット、ストッパー）の強度評価は、「3.2.1 荷重条件」にて設定した荷重及び荷重の組合せを踏まえて、評価対象部位に作用する応力等について確認するものである。</p> <p>(1) 評価項目 設計荷重に対してフレームは、設計飛来物が貫通せず非常用海水ポンプ等への到達を阻止できること（貫通評価）、また、非常用海水ポンプ等へ波及的影響を与えないよう落下が生じないこと（支持機能評価）を衝突解析により確認する。 大梁、フレームゴム支承、大梁ゴム支承、可動支承、ブラケット、ストッパーは、フレームで受けた荷重が伝達されるため、衝突解析に</p>	<p>て、ワイヤロープの張力に対し、破断しないことを確認する。 接続用の治具の破断評価は、計算により算出する応力により接続用の治具を破断しない強度を許容限界とする。</p> <p>③たわみ評価 竜巻防護ネット本体は、自重、設計竜巻の風圧力による荷重及び設計飛来物による衝撃荷重に対し、計算により算出する竜巻防護ネット本体の最大たわみ量がネットと原子炉補機冷却海水ポンプ等の離隔距離未満であることを確認するため、ネットと原子炉補機冷却海水ポンプ等の最小離隔距離を許容限界として設定する。</p> <p>4.1.2 ネット（鋼製枠） ネット（鋼製枠）の強度評価は、「3.2.1 荷重条件」にて設定した荷重及び荷重の組合せを踏まえて、評価対象部位に作用する応力等について確認するものである。</p> <p>(1) 評価項目 設計荷重に対してネット（鋼製枠）は、設計飛来物が貫通せず原子炉補機冷却海水ポンプ等への到達を阻止できること（貫通評価）、また、原子炉補機冷却海水ポンプ等へ波及的影響を与えないよう落下が生じないこと（支持機能評価）を衝突解析により確認する。 評価においては、飛来物の衝突位置により各部材に発生する応力が変わることから、各部材に対し最も条件の厳しい衝突箇所を考慮し評価を実施する。</p> <p>(2) 評価対象部位 ネット（鋼製枠）の強度評価においては、その構造を踏まえて、設計竜巻による荷重とこれに組み合わせる荷重（以下「設計荷重」という。）の作用方向及び伝達過程を考慮し、評価対象部位を設定する。</p> <p>4.1.3 架台及びブラケット 架台の強度評価は、「3.2.1 荷重条件」にて設定した荷重及び荷重の組合せを踏まえて、評価対象部位に作用する応力等について確認するものである。</p> <p>(1) 評価項目 設計荷重に対して架台は、設計飛来物が貫通せず原子炉補機冷却海水ポンプ等への到達を阻止できること（貫通評価）、また、原子炉補機冷却海水ポンプ等へ波及的影響を与えないよう落下が生じないこと（支持機能評価）を衝突解析により確認する。 ブラケットは、架台で受けた荷重が伝達されるため、衝突解析によって算出した荷重によって落下が生じないこと（支持機能評価）を確</p>	<p>て、ワイヤロープの張力に対し、破断しないことを確認する。 接続用の治具の破断評価は、計算により算出する応力により接続用の治具を破断しない強度を許容限界とする。</p> <p>③たわみ評価 竜巻防護ネット本体は、自重、設計竜巻の風圧力による荷重及び設計飛来物による衝撃荷重に対し、計算により算出する竜巻防護ネット本体の最大たわみ量がネットと原子炉補機冷却海水ポンプ等の離隔距離未満であることを確認するため、ネットと原子炉補機冷却海水ポンプ等の最小離隔距離を許容限界として設定する。</p> <p>4.1.2 ネット（鋼製枠） ネット（鋼製枠）の強度評価は、「3.2.1 荷重条件」にて設定した荷重及び荷重の組合せを踏まえて、評価対象部位に作用する応力等について確認するものである。</p> <p>(1) 評価項目 設計荷重に対してネット（鋼製枠）は、設計飛来物が貫通せず原子炉補機冷却海水ポンプ等への到達を阻止できること（貫通評価）、また、原子炉補機冷却海水ポンプ等へ波及的影響を与えないよう落下が生じないこと（支持機能評価）を衝突解析により確認する。 評価においては、飛来物の衝突位置により各部材に発生する応力が変わることから、各部材に対し最も条件の厳しい衝突箇所を考慮し評価を実施する。</p> <p>(2) 評価対象部位 ネット（鋼製枠）の強度評価においては、その構造を踏まえて、設計竜巻による荷重とこれに組み合わせる荷重（以下「設計荷重」という。）の作用方向及び伝達過程を考慮し、評価対象部位を設定する。</p> <p>4.1.3 架台及びブラケット 架台の強度評価は、「3.2.1 荷重条件」にて設定した荷重及び荷重の組合せを踏まえて、評価対象部位に作用する応力等について確認するものである。</p> <p>(1) 評価項目 設計荷重に対して架台は、設計飛来物が貫通せず原子炉補機冷却海水ポンプ等への到達を阻止できること（貫通評価）、また、原子炉補機冷却海水ポンプ等へ波及的影響を与えないよう落下が生じないこと（支持機能評価）を衝突解析により確認する。 ブラケットは、架台で受けた荷重が伝達されるため、衝突解析によって算出した荷重によって落下が生じないこと（支持機能評価）を確</p>	<p>紙は作成しない。</p> <p>【女川】 竜巻防護ネットで防護する対象機器の相違</p> <p>【女川】 ・構造の相違。 ・泊はネット鋼製枠が架台の上に設置されている構造のため、記載するもの。</p> <p>【女川】 記載表現の相違</p> <p>【女川】 竜巻防護ネットで防護する対象機器の相違</p> <p>【女川】 ネット構造の相違</p>

赤字：設備、運用又は体制の相違（設計方針の相違）
 青字：記載箇所又は記載内容の相違（記載方針の相違）
 緑字：記載表現、設備名称の相違（実質的な相違なし）

大飯発電所3/4号炉	女川原子力発電所2号炉	泊発電所3号炉	相違理由												
	<p>よって算出した荷重によって落下が生じないこと（支持機能評価）を確認する。</p> <p>評価においては、飛来物の衝突位置により各部材に発生する応力が変わることから、各部材に対し最も条件の厳しい衝突箇所を考慮し評価を実施する。</p> <p>支持部材に対する支持機能評価は、「3.8.3 設計上の配慮又は対策が必要となる事項に対する対応（1）」で定めたSTEP2で実施し、衝突解析におけるゴム支承、可動支承の解析条件を表16に整理する。</p> <table border="1" data-bbox="712 411 1326 791"> <caption>表16 衝突解析におけるゴム支承、可動支承の解析条件</caption> <thead> <tr> <th>解析条件</th> <th>ゴム支承</th> <th>可動支承</th> </tr> </thead> <tbody> <tr> <td>【STEP2-1】 （大梁、フレーム ゴム支承、大梁 ゴム支承、可動 支承、ブラケッ トの評価に適用）</td> <td>ゴム支承の結合条件を3方向固定（下部構造に対し、支承部のピーク荷重がそのまま伝達される条件で評価を実施）</td> <td></td> </tr> <tr> <td>【STEP2-2】 （フレームゴム 支承の評価に適用）</td> <td>ゴム支承の結合条件を耐震評価で用いるせん断剛性（実現象に近いと考えられる条件で評価を行う観点から適用する）</td> <td>可動方向の結合条件をフリー 反可動方向、鉛直方向の結合条件を固定</td> </tr> <tr> <td>【STEP2-3】 （ストッパーの評 価に適用）</td> <td>ゴム支承の結合条件をフリー（ゴム支承による荷重の負担を期待せず、ストッパーへかかる衝撃荷重が大きくなる条件で評価を実施）</td> <td></td> </tr> </tbody> </table> <p>(2) 評価対象部位</p> <p>支持部材の強度評価においては、その構造を踏まえて、設計荷重の作用方向及び伝達過程を考慮し、フレーム、大梁、フレームゴム支承、大梁ゴム支承、可動支承、ブラケット、ストッパーを評価対象部位として設定する。なお、ゴム支承と可動支承の部材のうち支持機能評価の対象部材については、飛来物衝突時及び衝突後の竜巻風荷重の役割を踏まえて選定する。（詳細は別紙2参照）</p> <p>また、図19～図21に各衝突方向からの設計飛来物衝突時の荷重伝達の例を示す。</p>	解析条件	ゴム支承	可動支承	【STEP2-1】 （大梁、フレーム ゴム支承、大梁 ゴム支承、可動 支承、ブラケッ トの評価に適用）	ゴム支承の結合条件を3方向固定（下部構造に対し、支承部のピーク荷重がそのまま伝達される条件で評価を実施）		【STEP2-2】 （フレームゴム 支承の評価に適用）	ゴム支承の結合条件を耐震評価で用いるせん断剛性（実現象に近いと考えられる条件で評価を行う観点から適用する）	可動方向の結合条件をフリー 反可動方向、鉛直方向の結合条件を固定	【STEP2-3】 （ストッパーの評 価に適用）	ゴム支承の結合条件をフリー（ゴム支承による荷重の負担を期待せず、ストッパーへかかる衝撃荷重が大きくなる条件で評価を実施）		<p>認する。</p> <p>評価においては、飛来物の衝突位置により各部材に発生する応力が変わることから、各部材に対し最も条件の厳しい衝突箇所を考慮し評価を実施する。</p> <p>(2) 評価対象部位</p> <p>支持部材の強度評価においては、その構造を踏まえて、設計荷重の作用方向及び伝達過程を考慮し、鋼製柱、架台、ブラケットを評価対象として選定する。</p> <p>また、図11～図13に各衝突方向からの設計飛来物衝突時の荷重伝達の例を示す。</p>	<p>【女川】</p> <ul style="list-style-type: none"> ・竜巻防護設備の構造の相違。 ・女川は竜巻防護ネットを設置する海水ポンプエリアの壁が薄く支持機能に期待できないため、可動支承、ゴム支承を採用して地震により生じる応力を低減・分散させる構造として、ネットの支持機能を確保している。 ・泊においては、女川と異なり竜巻防護ネットは強固な建屋床面、ブラケットを介してピット壁面に設置できる環境であることから、女川の竜巻防護ネットの可動支承のような可動式の機構を持たせる必要はない。 ・以上の理由から、泊の竜巻防護ネットは、先行プラント（大飯、高浜）と同様の竜巻防護ネットの構造を採用しており、架構に直接、竜巻防護ネットを設置する構造としている。
解析条件	ゴム支承	可動支承													
【STEP2-1】 （大梁、フレーム ゴム支承、大梁 ゴム支承、可動 支承、ブラケッ トの評価に適用）	ゴム支承の結合条件を3方向固定（下部構造に対し、支承部のピーク荷重がそのまま伝達される条件で評価を実施）														
【STEP2-2】 （フレームゴム 支承の評価に適用）	ゴム支承の結合条件を耐震評価で用いるせん断剛性（実現象に近いと考えられる条件で評価を行う観点から適用する）	可動方向の結合条件をフリー 反可動方向、鉛直方向の結合条件を固定													
【STEP2-3】 （ストッパーの評 価に適用）	ゴム支承の結合条件をフリー（ゴム支承による荷重の負担を期待せず、ストッパーへかかる衝撃荷重が大きくなる条件で評価を実施）														

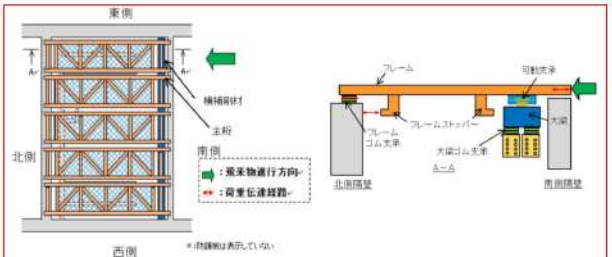
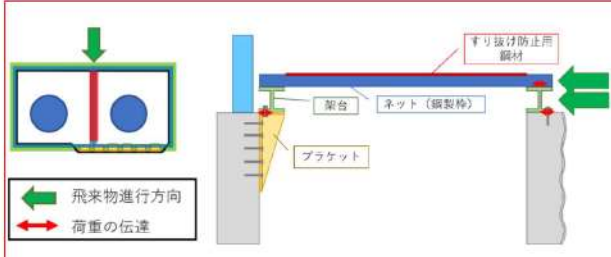
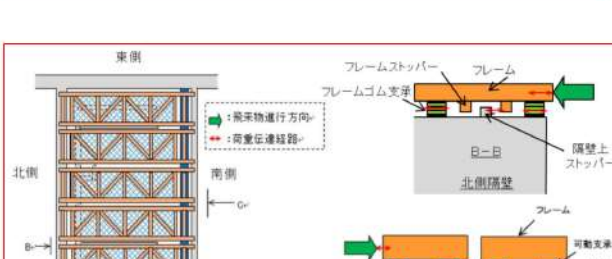
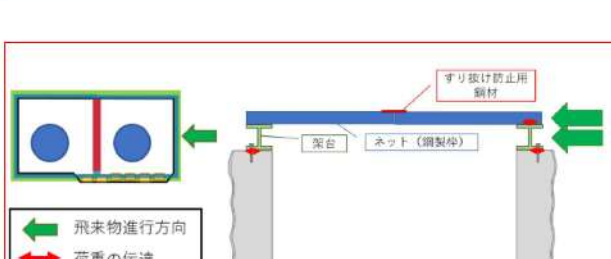
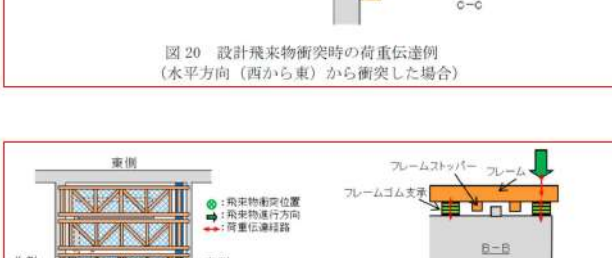
赤字：設備、運用又は体制の相違（設計方針の相違）
 青字：記載箇所又は記載内容の相違（記載方針の相違）
 緑字：記載表現、設備名称の相違（実質的な相違なし）

大飯発電所3/4号炉	女川原子力発電所2号炉	泊発電所3号炉	相違理由
 <p>図19 設計飛来物衝突時の荷重伝達例 （水平方向（南から北）から衝突した場合）</p>	 <p>図11 設計飛来物衝突時の荷重伝達例 （水平方向（北から南）から衝突した場合）</p>	<p>【女川】 構造の相違</p> <p>【女川】 記載表現の相違（図番）</p>	
 <p>図20 設計飛来物衝突時の荷重伝達例 （水平方向（西から東）から衝突した場合）</p>	 <p>図12 設計飛来物衝突時の荷重伝達例 （水平方向（東から西）から衝突した場合）</p>	<p>【女川】 構造の相違</p> <p>【女川】 記載表現の相違（図番）</p>	
 <p>図21 設計飛来物衝突時の荷重伝達例 （鉛直方向から衝突した場合）</p>	 <p>図13 設計飛来物衝突時の荷重伝達例 （鉛直方向から衝突した場合）</p>	<p>【女川】 構造の相違</p> <p>【女川】 記載表現の相違</p>	
<p>(3) 許容限界（詳細は別紙5参照）</p> <p>フレームは、評価対象部位に発生する最大ひずみが「NEI07-13」に基づく破断ひずみの範囲内であることを確認する。最大ひずみが破断ひずみを超える場合には、破断箇所を確認し、全断面に発生しないこと</p>	<p>(3) 許容限界</p> <p>架台は、評価対象部位に発生する最大ひずみが「NEI07-13」に基づく破断ひずみの範囲内であることを確認する。最大ひずみが破断ひずみを超える場合には、破断箇所を確認し、全断面に発生しないこと</p>	<p>【女川】 女川の別紙5には竜巻防護ネットの構造健全性評価基準について記</p>	

泊発電所3号炉 DB基準適合性 比較表

赤字：設備、運用又は体制の相違（設計方針の相違）
 青字：記載箇所又は記載内容の相違（記載方針の相違）
 緑字：記載表現、設備名称の相違（実質的な相違なし）

第6条 外部からの衝撃による損傷の防止（竜巻：別添資料1 添付資料3.13）

大飯発電所3/4号炉	女川原子力発電所2号炉	泊発電所3号炉	相違理由
	<p>とにより、貫通及び落下が生じないことを確認する。</p> <p>大梁、ゴム支承（構成部材のうち鋼製部品）、可動支承、ブラケット、ストッパーにおいては、「原子力発電所耐震設計技術指針（JEAG4601・補-1984）」に基づいて、許容応力状態IVASの許容応力を許容限界として設定する。ゴム支承のうちゴム部分については、「道路橋示方書・同解説V耐震設計編（H14.3）」に基づく評価基準値を設定する。</p>	<p>より、貫通及び落下が生じないことを確認する。</p>	<p>載されている。当該資料は、ゴム支承、可動支承の評価項目や許容限界等を整理する目的で作成されたと考えている。泊においては、ゴム支承、可動支承を採用していないため、設工認段階で女川の別紙5に対応する内容を記載するため、当該別紙は作成しない。</p> <p>【女川】 構造の相違</p> <p>【女川】</p> <ul style="list-style-type: none"> ・竜巻防護設備の構造の相違。 ・女川は竜巻防護ネットを設置する海水ポンプエリアの壁が薄く支持機能に期待できないため、可動支承、ゴム支承を採用して地震により生じる応力を低減・分散させる構造として、ネットの支持機能を確保している。 ・泊においては、女川と異なり竜巻防護ネットは強固な建屋床面、ブラケットを介してビット壁面に設置できる環境であることから、女川の竜巻防護ネットの可動支承のような可動式の機構を持たせる必要はない。 ・以上の理由から、泊の竜巻防護ネットは、先行プラント（大飯、高浜）と同様の竜巻防護ネットの構造を採用しており、架構に直接、竜巻防護ネットを設置する構造としている。

赤字:設備,運用又は体制の相違(設計方針の相違)
 青字:記載箇所又は記載内容の相違(記載方針の相違)
 緑字:記載表現,設備名称の相違(実質的な相違なし)

大飯発電所3/4号炉

女川原子力発電所2号炉

泊発電所3号炉

相違理由

(4)支持部材に対する性能目標と評価方針
 (1)~(3)を踏まえ、支持部材に対する構造強度上の性能目標と評価方針を表17に整理する。

表17 支持部材に対する構造強度上の性能目標と評価方針 (1/2)

評価対象	支持部材の設計方針	構造強度上の性能目標	構造強度上の評価方針	評価部材	主な機能損傷モード		許容限界
					作用荷重	限界状態	
竜巻防護ネット(支持部材)	【共通】 支持部材は設計竜巻の風圧力による荷重、飛来物による衝撃荷重及びその他の荷重に非常用海水ポンプ等へ衝突することを防止するため、飛来物が支持部材を構成する主要な構造部材を貫通せず、上載部材を貫通せず、上載部材を支持する機能を維持可能な構造強度を有し、非常用海水ポンプ等に波及的影響を与えないために、支持部材を構成する部材自体の転倒及び脱落を生じない設計とする。	【共通】 設計飛来物の支持部材への衝突に対して、衝突箇所での貫通させない。 【支持機能】 支持部材は設計竜巻の風圧力による荷重、飛来物による衝撃荷重及びその他の荷重に非常用海水ポンプ等を支持する機能を維持可能な構造強度を有する。	設計飛来物が支持部材に衝突した場合に、衝突箇所が発生する衝撃荷重によって貫通が生じないように、フレームの剛性が終局状態に至るようになり、竜巻の風圧力による衝撃荷重に耐え、上載するネットを支持するため、フレームの剛性が終局状態に至るようになり、貫通を生じないことを確認する。	フレーム	自重 ・上載荷重 (ネット) ・竜巻風荷重 ・衝撃荷重	(衝突面の)全断面欠損	NE10F-13HにIF(多相性脆型)を考慮して設計した破断ひずみ以下、最大ひずみが破断ひずみを超えない場合は、破断面を確保し、全断面に発生しないこと (IS-DINAによる衝突解析によりひずみ量を算出)
				大梁	自重 ・上載荷重(ネット、フレーム) ・竜巻風荷重 ・衝撃荷重	終局状態	発生する応力がJIS 4601の σ_{YS} 以下
			竜巻の風圧力による衝撃荷重に耐え、上載するフレーム等を支持する構造強度を維持するため、作用する応力が許容応力状態IV.Sの評価応力を超えないことを確認する。	ブракетт ブракетт-а -а-порт	自重 ・上載荷重(ネット、フレーム、大梁) ・竜巻風荷重 ・衝撃荷重		

※: NE10F-13:Technology for Performing Aircraft Impact Assessments for New Plant Design.

(4)支持部材に対する性能目標と評価方針
 (1)~(3)を踏まえ、支持部材に対する構造強度上の性能目標と評価方針を表9に整理する。

表9 支持部材に対する構造強度上の性能目標と評価方針

評価対象	支持部材の設計方針	構造強度上の性能目標	構造強度上の評価方針	評価部材	主な機能損傷モード		許容限界
					作用荷重	限界状態	
竜巻防護ネット(支持部材)	支持部材は設計竜巻の風圧力による荷重、飛来物による衝撃荷重及びその他の荷重に非常用海水ポンプ等へ衝突することを防止するため、飛来物が支持部材を構成する主要な構造部材を貫通せず、上載部材を貫通せず、上載部材を支持する機能を維持可能な構造強度を有し、非常用海水ポンプ等に波及的影響を与えないために、支持部材を構成する部材自体の転倒及び脱落を生じない設計とする。	【共通】 設計飛来物の支持部材への衝突に対して、衝突箇所での貫通させない。 【支持機能】 支持部材は設計竜巻の風圧力による荷重、飛来物による衝撃荷重及びその他の荷重に非常用海水ポンプ等を支持する機能を維持可能な構造強度を有する。	設計飛来物が支持部材に衝突した場合に、衝突箇所が発生する衝撃荷重によって貫通が生じないように、ネット(鋼製枠)の剛性が終局状態に至るようになり、貫通を生じないことを確認する。 竜巻の風圧力による衝撃荷重及び設計飛来物による衝撃荷重に耐え、上載する鋼製枠等を支持する構造強度を維持するため、作用する応力が許容応力状態IV.Sの評価応力を超えないことを確認する。	ネット(鋼製枠)	自重 ・上載荷重(ネット、鋼製枠) ・竜巻風荷重 ・衝撃荷重	(衝突面の)全断面欠損	破断ひずみ以下。 最大ひずみが破断ひずみを超えない場合は、破断面を確保し、全断面に発生しないこと
				架台 ブракетт 本体 ブракетт-а -а-порт	自重 ・上載荷重(ネット、ブракетт、ブракетт-а) ・竜巻風荷重 ・衝撃荷重	終局状態	発生する応力がJIS 4601の σ_{YS} 以下

【女川】
記載表現の相違

【女川】
防護ネットの構成部材の相違

【女川】
記載表現の相違(表番号)

赤字：設備、運用又は体制の相違（設計方針の相違）
 青字：記載箇所又は記載内容の相違（記載方針の相違）
 緑字：記載表現、設備名称の相違（実質的な相違なし）

大飯発電所3/4号炉	女川原子力発電所2号炉	泊発電所3号炉	相違理由
表17 支持部材に対する構造強度上の性能目標と評価方針 (2/2)			
評価対象	竜巻防護ネット（支持部材）		
支持部材の設計方針	支持部材は設計竜巻の風圧力による荷重、飛来物による衝撃荷重及びその他の荷重に対して、飛来物が非常用海水ポンプ等へ衝突することを防止するため、飛来物が支持部材を構成する主要な構造部材を貫通せず、構造部材を支持する機能を維持可能な構造強度を有し、非常用海水ポンプ等に波及的影響を与えないように設計とする。		
構造強度上の性能目標	【支持機能】 支持部材は設計竜巻の風圧力による荷重、飛来物による衝撃荷重及びその他の荷重に及び、防護板を支持する機能を維持可能な構造強度を有する。		
構造強度上の評価方針	竜巻の風圧力による荷重及び設計飛来物による衝撃荷重に対し、支持機能を維持するため、作用するに解凍V相設計仕様(014.3)又は許容応力状態IVSの許容応力に基づく基礎値を超えないことを確認する。		
評価項目	大飯ゴム支承 可動支承		
評価部材	ゴム体 内部鋼板 大飯ゴム支承取付ボルト ゴム体 内部鋼板 取付ボルト アンカーボルト フレームプレート ベースボルト レール 可動支承 竜巻防護ネット ベースプレート		
主な作用荷重	・自重 ・上載荷重(ネット、フレーム、大飯) ・竜巻風荷重 ・衝撃荷重 ・自重 ・上載荷重(ネット、フレーム) ・竜巻風荷重 ・衝撃荷重 ・自重 ・上載荷重(ネット、フレーム) ・竜巻風荷重 ・衝撃荷重		
許容限界	・発生する引張応力が道筋構造を考慮して発生するせん断応力の許容値以下 ・発生する応力がJIS 4001のIVS以下 ・発生する応力がJIS 4001のIVS以下 ・発生する応力がJIS 4001のIVS以下 ・発生する応力がJIS 4001のIVS以下		
境界状態	終局状態 終局状態 終局状態		
許容限界	・発生する応力がJIS 4001のIVS以下 ・発生する応力がJIS 4001のIVS以下 ・発生する応力がJIS 4001のIVS以下 ・発生する応力がJIS 4001のIVS以下		
*1：フレームゴム支承は、2つのうち1つ以上の支承が構造強度上の性能目標を満足することを確認することを確認する。詳細設計段階で許容限界を満足しない結果となった場合、二次的影響評価を実施する。			
(4) 評価結果	STEP2の評価結果を別紙4に整理する。 竜巻防護ネットの支持部材のうち、可動支承を除く部材については構造強度上の評価方針を満足し、飛来物衝突時及び衝突後において竜巻防護ネットの支持機能を維持することから、構造成立性の見通しがあることを確認した。 可動支承については、詳細設計段階で、サイズアップやボルトの仕様変更等の対応を行うことで、許容値を満足させる方針とする。		
(4) 評価結果	評価結果については詳細設計段階で整理する。 詳細設計段階で、仕様変更等の対応を行うことで、許容値を満足させる方針とする。		
【女川】	防護ネットの構成部材の相違 【女川】 記載表現の相違（表番号）		
【女川】	記載方針の相違。 泊においては、設工認の段階で構造成立性を示す。		

泊発電所3号炉 DB基準適合性 比較表

赤字：設備、運用又は体制の相違（設計方針の相違）
 青字：記載箇所又は記載内容の相違（記載方針の相違）
 緑字：記載表現、設備名称の相違（実質的な相違なし）

第6条 外部からの衝撃による損傷の防止（竜巻：別添資料1 添付資料3.13）

大飯発電所3/4号炉	女川原子力発電所2号炉	泊発電所3号炉	相違理由
<p>4.1.3 防護板</p> <p>防護板の強度評価は、「3.2.1 荷重条件」にて設定した荷重及び荷重の組合せを踏まえて、評価対象部位に作用する応力等の評価方針について確認するものである。</p> <p>(1) 評価項目</p> <p>非常用海水ポンプ等が安全機能を損なうことのないことの確認として、設計飛来物が防護板に衝突した場合の貫通に対する評価(以下「貫通評価」という)を実施し、非常用海水ポンプ等に到達しないことを確認する。</p> <p>(2) 評価対象部位</p> <p>防護板は設計飛来物の衝突に対し、非常用海水ポンプ等を防護するための設備であることから評価対象部位とする。</p> <p>(3) 許容限界（詳細は別紙5参照）</p> <p>防護板の貫通評価における許容限界は、防護板の板厚が貫通限界厚さを上回る値とする。貫通限界厚さは「タービンミサイル評価について(昭和52年7月20日原子炉安全専門審査会)」で用いられているBRL式を用いて算出する。</p> <p>5. 竜巻以外の自然現象（地震、津波含む）に対する評価方針</p> <p>5.1 竜巻以外の自然現象に対する評価</p> <p>(1) 竜巻以外の自然現象の影響抽出</p> <p>竜巻防護ネットは、竜巻以外の自然現象によって非常用海水ポンプ等に波及的影響を及ぼさないことを確認する。</p> <p>竜巻防護ネットに対する竜巻以外の自然現象（地震、津波含む）の影響を、表18に示す。</p> <p>竜巻防護ネットを設置する海水ポンプ室（コンクリート壁含む）</p>	<p>4.1.4 すり抜け防止用鋼材</p> <p>すり抜け防止用鋼材の強度評価は、「3.2.1 荷重条件」にて設定した荷重及び荷重の組合せを踏まえて、評価対象部位に作用する応力等の評価方針について確認するものである。</p> <p>(1) 評価項目</p> <p>原子炉補機冷却海水ポンプ等が安全機能を損なうことのないことの確認として、設計飛来物が防護板に衝突した場合の貫通に対する評価(以下「貫通評価」という)を実施し、原子炉補機冷却海水ポンプ等に到達しないことを確認する。</p> <p>(2) 評価対象部位</p> <p>すり抜け防止用鋼材は設計飛来物の衝突に対し、原子炉補機冷却海水ポンプ等を防護するための設備であることから評価対象部位とする。</p> <p>(3) 許容限界</p> <p>すり抜け防止用鋼材の貫通評価における許容限界は、破断ひずみの範囲内であることを確認する。最大ひずみが破断ひずみを超える場合には、破断箇所を確認し、全断面に発生しないことにより、貫通及び落下が生じないことを確認する。</p> <p>5. 竜巻以外の自然現象（地震、津波含む）に対する評価方針</p> <p>5.1 竜巻以外の自然現象に対する評価</p> <p>(1) 竜巻以外の自然現象の影響抽出</p> <p>竜巻防護ネットは、竜巻以外の自然現象によって原子炉補機冷却海水ポンプ等に波及的影響を及ぼさないことを確認する。</p> <p>竜巻防護ネットに対する竜巻以外の自然現象（地震、津波含む）の影響を表10に示す。</p> <p>竜巻防護ネットを設置する取水ビットポンプ室（コンクリート壁含む）</p>	<p>【女川】 記載表現の相違</p> <p>【女川】 防護ネットの構成部材の相違</p> <p>【女川】 竜巻防護ネットで防護する対象機器の相違</p> <p>【女川】 防護ネットの構成部材の相違</p> <p>【女川】 女川の別紙5には竜巻防護ネットの構造健全性評価基準について記載されている。当該資料は、ゴム支承、可動支承の評価項目や許容限界等を整理する目的で作成されたと考えている。泊においては、ゴム支承、可動支承を採用していないため、設工認段階で女川の別紙5に対応する内容を記載するため、当該別紙は作成しない。</p> <p>【女川】 鋼製部材の評価方法の相違</p> <p>【女川】</p>	

赤字：設備、運用又は体制の相違（設計方針の相違）
 青字：記載箇所又は記載内容の相違（記載方針の相違）
 緑字：記載表現、設備名称の相違（実質的な相違なし）

大飯発電所3/4号炉	女川原子力発電所2号炉	泊発電所3号炉	相違理由																																																																					
	<p>及び 竜巻防護ネットの耐震評価方針については、設置許可基準規則第4条に対する適合状況説明資料『設計基準対象施設について（第4条地震による損傷の防止）』で説明する。</p> <table border="1" data-bbox="712 316 1328 770"> <caption>表 18 竜巻防護ネットに対する竜巻以外の自然現象（地震、津波含む）の影響</caption> <thead> <tr> <th>事象</th> <th>確認結果</th> <th>考慮の要否</th> </tr> </thead> <tbody> <tr> <td>風（台風）</td> <td>・風（台風）の荷重を考慮する ・風による振動の影響を考慮する</td> <td>○</td> </tr> <tr> <td>凍結</td> <td>・設備構造上、凍結の影響を受けない</td> <td>—</td> </tr> <tr> <td>降水</td> <td>・構内排水施設により排水することで設備が浸水することはない</td> <td>—</td> </tr> <tr> <td>積雪</td> <td>・積雪荷重を考慮する</td> <td>○ (荷重)</td> </tr> <tr> <td>落雷</td> <td>・電気設備を持たないことから電気的影響を受けない</td> <td>—</td> </tr> <tr> <td>火山の影響</td> <td>・降下火砕物の荷重を考慮する ・腐食に対しては金属材料を用い、重鉛メッキや外装塗装を実施していることから短期的な影響は小さい ・設備構造上、降下火砕物による閉塞・摩耗・電気的影響を受けない</td> <td>○ (荷重)</td> </tr> <tr> <td>生物学的事象</td> <td>・設備構造上、生物学的事象の影響を受けない</td> <td>—</td> </tr> <tr> <td>森林火災</td> <td>・防火帯により、森林から約300mの隔離がある ・設備構造上、ばい煙による影響を受けない</td> <td>—</td> </tr> <tr> <td>地震</td> <td>・地震の荷重を考慮する (第4条 地震による損傷の防止)参照</td> <td>○ (荷重)</td> </tr> <tr> <td>津波</td> <td>・基準津波は津波防護施設及び浸水防止設備により敷地内に到達することはないため、荷重・浸水の影響を受けない (第5条 津波による損傷の防止)</td> <td>—</td> </tr> </tbody> </table> <p>(2) 設計条件 竜巻以外の自然現象による波及的影響の評価の条件を以下に示す。 a. 荷重条件 (a) 風（台風）による荷重 風（台風）による荷重は、建設省告示第1454号に定められた女川町の基準風速30m/sによる荷重とする。 (b) 積雪荷重 積雪荷重として以下の条件を考慮する。 積雪量：43cm（積雪深さの月最大値）*1 単位荷重：20N/m2*2 *1：建築基準法施行細則（宮城県）に定められる女川町の垂直積雪量は40cmであるが、保守的に既往最大である垂直積雪量43cmを用いる。 *2：建築基準法施行令に基づく積雪の単位荷重（積雪1cm当たり20N/m2） (c) 火山の影響による荷重 火山事象における降下火砕物による静的荷重として以下の条件を考慮する。 堆積量：15cm 密度：1.5g/cm3（湿潤状態）</p>	事象	確認結果	考慮の要否	風（台風）	・風（台風）の荷重を考慮する ・風による振動の影響を考慮する	○	凍結	・設備構造上、凍結の影響を受けない	—	降水	・構内排水施設により排水することで設備が浸水することはない	—	積雪	・積雪荷重を考慮する	○ (荷重)	落雷	・電気設備を持たないことから電気的影響を受けない	—	火山の影響	・降下火砕物の荷重を考慮する ・腐食に対しては金属材料を用い、重鉛メッキや外装塗装を実施していることから短期的な影響は小さい ・設備構造上、降下火砕物による閉塞・摩耗・電気的影響を受けない	○ (荷重)	生物学的事象	・設備構造上、生物学的事象の影響を受けない	—	森林火災	・防火帯により、森林から約300mの隔離がある ・設備構造上、ばい煙による影響を受けない	—	地震	・地震の荷重を考慮する (第4条 地震による損傷の防止)参照	○ (荷重)	津波	・基準津波は津波防護施設及び浸水防止設備により敷地内に到達することはないため、荷重・浸水の影響を受けない (第5条 津波による損傷の防止)	—	<p>む）及び原子炉補機冷却海水ポンプ出口ストレーナ室（コンクリート壁含む）の竜巻防護ネットの耐震評価方針については、設置許可基準規則第4条に対する適合状況説明資料『設置許可基準規則等への適合状況について（設計基準対象施設等） 第4条 地震による損傷の防止』で説明する。</p> <table border="1" data-bbox="1346 304 1957 786"> <caption>表 10 竜巻防護ネットに対する竜巻以外の自然現象（地震、津波含む）の影響</caption> <thead> <tr> <th>事象</th> <th>確認結果</th> <th>考慮の要否</th> </tr> </thead> <tbody> <tr> <td>風（台風）</td> <td>・建屋内に設置するため風（台風）の影響を受けない</td> <td>—</td> </tr> <tr> <td>凍結</td> <td>・設備構造上、凍結の影響を受けない</td> <td>—</td> </tr> <tr> <td>降水</td> <td>・構内排水施設により排水することで設備が浸水することはない</td> <td>—</td> </tr> <tr> <td>積雪</td> <td>・建屋内に設置するため積雪の影響を受けない</td> <td>—</td> </tr> <tr> <td>落雷</td> <td>・電気設備を持たないことから電気的影響を受けない</td> <td>—</td> </tr> <tr> <td>地滑り</td> <td>・地滑り地形から隔離距離を確保した位置に設置するため、地滑りの影響を受けない</td> <td>—</td> </tr> <tr> <td>火山の影響</td> <td>・建屋内に設置するため降下火砕物の荷重の影響を受けない ・腐食に対しては金属材料を用い、重鉛メッキや外装塗装を実施していることから短期的な影響は小さい ・設備構造上、降下火砕物による閉塞・摩耗・電気的影響を受けない</td> <td>—</td> </tr> <tr> <td>生物学的事象</td> <td>・設備構造上、生物学的事象の影響を受けない</td> <td>—</td> </tr> <tr> <td>森林火災</td> <td>・防火帯により、森林から約300mの隔離がある ・設備構造上、ばい煙による影響を受けない</td> <td>—</td> </tr> <tr> <td>地震</td> <td>・地震の荷重を考慮する (第4条 地震による損傷の防止)参照</td> <td>○ (荷重)</td> </tr> <tr> <td>津波</td> <td>・基準津波は津波防護施設及び浸水防止設備により敷地内に到達することはないため、荷重・浸水の影響を受けない (第5条 津波による損傷の防止)</td> <td>—</td> </tr> </tbody> </table> <p>(2) 設計条件 竜巻以外の自然現象による波及的影響の評価の条件を以下に示す。 a. 荷重条件</p>	事象	確認結果	考慮の要否	風（台風）	・ 建屋内に設置するため風（台風）の影響を受けない	—	凍結	・設備構造上、凍結の影響を受けない	—	降水	・構内排水施設により排水することで設備が浸水することはない	—	積雪	・ 建屋内に設置するため積雪の影響を受けない	—	落雷	・電気設備を持たないことから電気的影響を受けない	—	地滑り	・地滑り地形から隔離距離を確保した位置に設置 するため 、地滑りの影響を受けない	—	火山の影響	・ 建屋内に設置するため降下火砕物の荷重の影響を受けない ・腐食に対しては金属材料を用い、重鉛メッキや外装塗装を実施していることから短期的な影響は小さい ・設備構造上、降下火砕物による閉塞・摩耗・電気的影響を受けない	—	生物学的事象	・設備構造上、生物学的事象の影響を受けない	—	森林火災	・防火帯により、森林から約300mの隔離がある ・設備構造上、ばい煙による影響を受けない	—	地震	・地震の荷重を考慮する (第4条 地震による損傷の防止)参照	○ (荷重)	津波	・基準津波は津波防護施設及び浸水防止設備により敷地内に到達することはないため、荷重・浸水の影響を受けない (第5条 津波による損傷の防止)	—	<p>設置場所の相違 【女川】 記載表現の相違</p> <p>【女川】 記載表現の相違（表番号）</p> <p>【女川】 泊は防護ネットが屋内設置であることによる想定事象の相違 ・設計方針の相違 ・泊は立地的要因により地滑りを考慮する</p> <p>【女川】 ・設置状況の相違 ・泊は防護ネットが屋内設置であることによる想定事象の相違</p>
事象	確認結果	考慮の要否																																																																						
風（台風）	・風（台風）の荷重を考慮する ・風による振動の影響を考慮する	○																																																																						
凍結	・設備構造上、凍結の影響を受けない	—																																																																						
降水	・構内排水施設により排水することで設備が浸水することはない	—																																																																						
積雪	・積雪荷重を考慮する	○ (荷重)																																																																						
落雷	・電気設備を持たないことから電気的影響を受けない	—																																																																						
火山の影響	・降下火砕物の荷重を考慮する ・腐食に対しては金属材料を用い、重鉛メッキや外装塗装を実施していることから短期的な影響は小さい ・設備構造上、降下火砕物による閉塞・摩耗・電気的影響を受けない	○ (荷重)																																																																						
生物学的事象	・設備構造上、生物学的事象の影響を受けない	—																																																																						
森林火災	・防火帯により、森林から約300mの隔離がある ・設備構造上、ばい煙による影響を受けない	—																																																																						
地震	・地震の荷重を考慮する (第4条 地震による損傷の防止)参照	○ (荷重)																																																																						
津波	・基準津波は津波防護施設及び浸水防止設備により敷地内に到達することはないため、荷重・浸水の影響を受けない (第5条 津波による損傷の防止)	—																																																																						
事象	確認結果	考慮の要否																																																																						
風（台風）	・ 建屋内に設置するため風（台風）の影響を受けない	—																																																																						
凍結	・設備構造上、凍結の影響を受けない	—																																																																						
降水	・構内排水施設により排水することで設備が浸水することはない	—																																																																						
積雪	・ 建屋内に設置するため積雪の影響を受けない	—																																																																						
落雷	・電気設備を持たないことから電気的影響を受けない	—																																																																						
地滑り	・地滑り地形から隔離距離を確保した位置に設置 するため 、地滑りの影響を受けない	—																																																																						
火山の影響	・ 建屋内に設置するため降下火砕物の荷重の影響を受けない ・腐食に対しては金属材料を用い、重鉛メッキや外装塗装を実施していることから短期的な影響は小さい ・設備構造上、降下火砕物による閉塞・摩耗・電気的影響を受けない	—																																																																						
生物学的事象	・設備構造上、生物学的事象の影響を受けない	—																																																																						
森林火災	・防火帯により、森林から約300mの隔離がある ・設備構造上、ばい煙による影響を受けない	—																																																																						
地震	・地震の荷重を考慮する (第4条 地震による損傷の防止)参照	○ (荷重)																																																																						
津波	・基準津波は津波防護施設及び浸水防止設備により敷地内に到達することはないため、荷重・浸水の影響を受けない (第5条 津波による損傷の防止)	—																																																																						

泊発電所3号炉 DB基準適合性 比較表

赤字：設備、運用又は体制の相違（設計方針の相違）
 青字：記載箇所又は記載内容の相違（記載方針の相違）
 緑字：記載表現、設備名称の相違（実質的な相違なし）

第6条 外部からの衝撃による損傷の防止（竜巻：別添資料1 添付資料3.13）

大飯発電所3/4号炉	女川原子力発電所2号炉	泊発電所3号炉	相違理由
	<p>(d)地震荷重 波及的影響の評価は基準地震動 Ss による地震力に対して実施する。 竜巻防護ネットには、ゴム支承、可動支承を用いており、ゴム支承、可動支承をモデル化した3次元はりモデルによる地震応答解析は、他プラントを含む既工認及び新規制審査での適用実績がない。 そのため、耐震設計の審査において既工認との手法の相違点を整理し、説明をしている。（設置許可基準規則第4条に対する適合状況説明資料『設計基準対象施設について（第4条地震による損傷の防止）』別紙-1参照）</p> <p>b. 荷重の組合せ 荷重の組合せは「女川原子力発電所2号炉外部事象の考慮について」に示す自然現象の組合せの方針に従い、以下のとおりとする。</p> <p>(a)地震荷重+風荷重 地震と風については、ともに最大荷重の継続時間が短く、同時に発生する確率は低い。また、竜巻防護ネットは風荷重の影響が大きいと考えられるような構造や形状の施設でないため、地震荷重と風荷重との組合せは考慮しない。</p>	<p>(a)地震荷重 波及的影響の評価は基準地震動 Ss による地震力に対して実施する。</p> <p>b. 荷重の組合せ 荷重の組合せは「泊発電所3号炉外部事象の考慮について」に示す自然現象の組合せの方針に従い、以下のとおりとする。</p> <p>(a)地震荷重+風荷重 地震と風については、ともに最大荷重の継続時間が短く、同時に発生する確率は低い。また、竜巻防護ネットは風荷重の影響が大きいと考えられるような構造や形状の施設でないため、地震荷重と風荷重との組合せは考慮しない。</p>	<p>【女川】 記載表現の相違</p> <p>【女川】 ・竜巻防護設備の構造の相違。 ・女川は竜巻防護ネットを設置する海水ポンプエリアの壁が薄く支持機能に期待できないため、可動支承、ゴム支承を採用して地震により生じる応力を低減・分散させる構造として、ネットの支持機能を確保している。 ・泊においては、女川と異なり竜巻防護ネットは強固な建屋床面、ブラケットを介してピット壁面に設置できる環境であることから、女川の竜巻防護ネットの可動支承のような可動式の機構を持たせる必要はない。 ・以上の理由から、泊の竜巻防護ネットは、先行プラント（大飯、高浜）と同様の竜巻防護ネットの構造を採用しており、架構に直接、竜巻防護ネットを設置する構造としている。</p> <p>【女川】 記載表現の相違</p>

赤字：設備、運用又は体制の相違（設計方針の相違）
 青字：記載箇所又は記載内容の相違（記載方針の相違）
 緑字：記載表現、設備名称の相違（実質的な相違なし）

大飯発電所3/4号炉	女川原子力発電所2号炉	泊発電所3号炉	相違理由
	<p>(b)地震荷重+積雪荷重 女川原子力発電所は多雪地域ではないため、建築基準法による「積雪荷重と他の荷重の組合せ」を考慮する必要はないが、原子力発電所の重要性を鑑み、多雪区域の基準を準用して、建築基準法施行令の積雪荷重に地震や暴風と組合せる際に用いる平均的な積雪荷重を与えるための係数0.35の係数を考慮して地震評価における静的荷重として組み合わせる。</p> <p>(c)降下火砕物荷重+風荷重+積雪荷重 降下火砕物荷重と風荷重及び積雪荷重の組合せは、3つの荷重が同時に発生することを考慮し、施設の形状、配置により適切に組み合わせることとしている。</p> <p>ただし、竜巻防護ネットは風荷重の影響が大きいと考えられるような構造や形状の施設でないため、上記3つの荷重のうち降下火砕物荷重と積雪荷重の組合せを考慮する。</p> <p>組み合わせる荷重は、降下火砕物荷重と積雪荷重は相関性が低い事象の組合せであるが、個別の事象が重畳した場合には堆積荷重が増加すると考えられるため、Turkstraの法則を適用して設定することとし、降下火砕物による荷重を主荷重（湿潤状態の降下火砕物の荷重（層厚15cm））、積雪による荷重（石巻における年最大積雪深さの平均値17cm）を従荷重として組み合わせる。</p> <p>c. 風（台風）による振動の影響 一定の風が継続して吹く場合、風による共振が発生する可能性が考えられるため、風による共振への影響について検討し、必要に応じ、竜巻防護ネットの構造設計に反映する。</p> <p>6. 竜巻随伴事象に対する評価 (1)火災 竜巻随伴事象として、建屋外については、発電所敷地内の屋外にある危険物貯蔵施設等の火災がある。火災源と竜巻防護ネットの位置関係を踏まえて火災の影響を評価（「6条（外部火災）」により評価）した上で、竜巻防護ネットが非常用海水ポンプ等に波及的影響を及ぼさない設計とする。</p> <p>また、竜巻防護ネットは発火性、引火性のある物質を使用しないため、火災の原因とはならない。</p> <p>(2)溢水 建屋外については、設計竜巻による飛来物の衝突による屋外タンク等の破損に伴う溢水を想定されるが、竜巻防護ネットは構造上、溢水により機能を損なわないため、溢水により竜巻防護ネットが非常用海水ポンプ等に波及的影響を及ぼすことはない。</p> <p>また、竜巻防護ネットは液体を内包する構造でないため、溢水の原因とはならない。</p> <p>(3)外部電源喪失 設計竜巻又は設計竜巻と同時に発生する雷又はダウンバースト等の</p>	<p>6. 竜巻随伴事象に対する評価 (1)火災 竜巻随伴事象として、建屋外については、発電所敷地内の屋外にある危険物貯蔵施設等の火災がある。火災源と竜巻防護ネットの位置関係を踏まえて火災の影響を評価（「6条（外部火災）」により評価）した上で、竜巻防護ネットが原子炉補機冷却海水ポンプ等に波及的影響を及ぼさない設計とする。</p> <p>また、竜巻防護ネットは発火性、引火性のある物質を使用しないため、火災の原因とはならない。</p> <p>(2)溢水 建屋外については、設計竜巻による飛来物の衝突による屋外タンク等の破損に伴う溢水を想定されるが、竜巻防護ネットは構造上、溢水により機能を損なわないため、溢水により竜巻防護ネットが原子炉補機冷却海水ポンプ等に波及的影響を及ぼすことはない。</p> <p>また、竜巻防護ネットは液体を内包する構造でないため、溢水の原因とはならない。</p> <p>(3)外部電源喪失 設計竜巻又は設計竜巻と同時に発生する雷又はダウンバースト等の</p>	<p>【女川】</p> <ul style="list-style-type: none"> ・設置状況の相違 ・泊は防護ネットが屋内設置であることによる想定事象の相違。

泊発電所3号炉 DB基準適合性 比較表

赤字：設備、運用又は体制の相違（設計方針の相違）
 青字：記載箇所又は記載内容の相違（記載方針の相違）
 緑字：記載表現、設備名称の相違（実質的な相違なし）

第6条 外部からの衝撃による損傷の防止（竜巻：別添資料1 添付資料3.13）

大飯発電所3/4号炉	女川原子力発電所2号炉	泊発電所3号炉	相違理由
<p>影響により外部電源喪失が想定されるが、竜巻防護ネットは、電源を用いておらず、外部電源喪失の影響を受けないため非常用海水ポンプ等に波及的影響を及ぼすことはない。また、竜巻防護ネットは飛来物化せず、送電網に関する施設等を損傷させることはないから、外部電源喪失の原因とならない。</p> <p>7. 竜巻防護ネットの維持管理について 竜巻防護ネットは、非常用海水ポンプ等を竜巻による飛来物から防護する機能及び、非常用海水ポンプ等に波及的影響を与えないための設備であることから、設置環境や、部材の劣化、故障モード等を踏まえた管理基準を定め、保全計画を策定し、点検を実施することにより、適切に設備の維持管理を実施する。 非常用海水ポンプ等の点検時には、竜巻防護ネットのフレームの取外し、取付けを実施することから、接続部（可動支承等）の健全性を確認して据付を実施する。 また、予備品の確保等により、部材が損傷した場合であっても、速やかに補修が行えるようにする。</p>	<p>影響により外部電源喪失が想定されるが、竜巻防護ネットは、電源を用いておらず、外部電源喪失の影響を受けないため原子炉補機冷却海水ポンプ等に波及的影響を及ぼすことはない。また、竜巻防護ネットは飛来物化せず、送電網に関する施設等を損傷させることはないから、外部電源喪失の原因とならない。</p> <p>7. 竜巻防護ネットの維持管理について 竜巻防護ネットは、原子炉補機冷却海水ポンプ等を竜巻による飛来物から防護する機能及び、原子炉補機冷却海水ポンプ等に波及的影響を与えないための設備であることから、設置環境や部材の劣化、故障モード等を踏まえた管理基準を定め、保全計画を策定し、点検を実施することにより、適切に設備の維持管理を実施する。 原子炉補機冷却海水ポンプ等の点検時には、竜巻防護ネットの取外し、取付けを実施することから、接続部の健全性を確認して据付を実施する。 また、予備品の確保等により、部材が損傷した場合であっても、速やかに補修が行えるようにする。</p>	<p>【女川】 ・竜巻防護設備の構造の相違。 ・女川は竜巻防護ネットを設置する海水ポンプエリアの壁が薄く支持機能に期待できないため、可動支承、ゴム支承を採用して地震により生じる応力を低減・分散させる構造として、ネットの支持機能を確保している。 ・泊においては、女川と異なり竜巻防護ネットは強固な建屋床面、ブラケットを介してピット壁面に設置できる環境であることから、女川の竜巻防護ネットの可動支承のような可動式の機構を持たせる必要はない。 ・以上の理由から、泊の竜巻防護ネットは、先行プラント（大飯、高浜）と同様の竜巻防護ネットの構造を採用しており、架構に直接、竜巻防護ネットを設置する構造としている。</p>	

泊発電所3号炉 DB基準適合性 比較表

赤字：設備、運用又は体制の相違（設計方針の相違）
 青字：記載箇所又は記載内容の相違（記載方針の相違）
 緑字：記載表現、設備名称の相違（実質的な相違なし）

第6条 外部からの衝撃による損傷の防止（竜巻：別添資料1 添付資料3.13）

大飯発電所3/4号炉	女川原子力発電所2号炉	泊発電所3号炉	相違理由
	<p>8. 設置許可段階と工認段階における説明内容</p> <p>設置許可段階では、STEP1 及びSTEP2 の評価のとおり、竜巻防護ネットの構造成立性に係る代表的な評価結果をもって、構造成立性の見通しを説明した。詳細設計段階では、設置許可断面の評価を踏まえて詳細設計を行い、改めて竜巻防護ネットの強度計算結果を説明する。 (別紙6参照)</p>	<p>8. 設置許可段階と工認段階における説明内容</p> <p>設置許可段階では、竜巻防護ネットの構造成立性に係る設計方針を説明した。詳細設計段階では、設置許可断面の設計方針を踏まえて詳細設計を行い、竜巻防護ネットの強度計算結果を説明する。</p>	<p>【女川】 設置許可と設工認での記載方針の相違</p>

赤字：設備、運用又は体制の相違（設計方針の相違）
 青字：記載箇所又は記載内容の相違（記載方針の相違）
 緑字：記載表現、設備名称の相違（実質的な相違なし）

大飯発電所3/4号炉	女川原子力発電所2号炉	泊発電所3号炉	相違理由																								
	別紙 1																										
	<p>竜巻防護ネットの設計方針に関する先行プラントとの比較</p> <p>竜巻防護ネットの設計方針等について、先行プラントと比較した結果を表1に整理する。構成部材のうち、ネット（金網部）と防護板は先行プラントと構造設計の相違がないが、ゴム支承及び可動支承を用いることで先行プラントと支持部材が異なることを踏まえて、支持部材に対する設計方針について比較を実施した。</p>																										
	<table border="1" data-bbox="712 443 1328 1054"> <caption>表1 竜巻に対する設計の基本方針、竜巻防護ネットの設計方針等の比較</caption> <thead> <tr> <th>プラント</th> <th>女川</th> <th>(参考) 東海第二</th> <th>相違理由</th> </tr> </thead> <tbody> <tr> <td>竜巻に対する設計の基本方針</td> <td>竜巻飛来物防護対策設備は、竜巻防護ネット、防護網板等から構成し、飛来物から外部事象防護対象施設を防護できる設計とする。 (主とめ資料:1.8.2.1設計方針(1) 竜巻に対する設計の基本方針より抜粋)</td> <td>竜巻飛来物防護対策設備は、防護ネット、防護網板等から構成し、飛来物から外部事象防護対象施設を防護できる設計とする。 【設備変更許可申請書（一部補正）1.7.2.1設計方針(1) 竜巻に対する設計の基本方針より抜粋】</td> <td>差異無し</td> </tr> <tr> <td>竜巻防護ネットの設計方針</td> <td>竜巻防護ネットは、竜巻時及び竜巻通過後において、設計竜巻荷重及びその他考慮すべき荷重に対し、内包する非常用海水ポンプ等が安全機能を損なわないよう、設計飛来物が非常用海水ポンプ等に衝突することを防止可能な設計とする。 また、竜巻防護ネットは、その他考えられる自然現象に対して、非常用海水ポンプ等に波及的影響を及ぼさない設計とする。</td> <td>防護対策施設は、竜巻時及び竜巻通過後において、設計竜巻荷重及びその他考慮すべき荷重に対し、内包する外部事象防護対象施設が安全機能を損なわないよう、設計飛来物等が外部事象防護対象施設に衝突することを防止可能な設計とする。 また、防護対策施設は、その他考えられる自然現象（地震等）に対して、外部事象防護対象施設に波及的影響を及ぼさない設計とする。 【工藤 V-1-1-2-3-1 竜巻への配慮に関する基本方針 2.1.3 竜巻の影響を考慮する施設の竜巻防護設計方針 c. 防護対策施設】</td> <td>設備名称の相違</td> </tr> <tr> <td>支持部材の設計方針</td> <td>支持部材は設計竜巻の風圧力による荷重、飛来物による衝撃荷重及びその他の荷重に対し、飛来物が非常用海水ポンプ等へ衝突することを防止するために、飛来物が防護部材を構成する主要な構造部材を貫通せず、上載するネット及び防護板を支持する機能を維持可能な構造強度を有し、非常用海水ポンプ等に波及的影響を与えないために、支持部材を構成する部材自体の転倒及び脱落を生じない設計とする。</td> <td>架橋は、設計竜巻の風圧力による荷重、飛来物による衝撃荷重及びその他の荷重に対し、飛来物が外部事象防護対象施設へ衝突することを防止するために、飛来物が架橋を構成する主要な構造部材を貫通せず、上載する防護ネット及び防護網板を支持する機能を維持可能な構造強度を有し、外部事象防護対象施設に波及的影響を与えないために、架橋を構成する部材自体の転倒及び脱落を生じない設計とする 【工藤 V-9-別添 1-2 防護対策施設の強度計算の方針 2.2 構造強度の設計方針 (3) 架橋】</td> <td>部材名称の相違 設備名称の相違</td> </tr> <tr> <td>支持機能を担持する部材</td> <td>フレーム、大梁、ブACKET、ゴム支承、可動支承、ストッパ</td> <td>架橋</td> <td>支持構造の相違</td> </tr> <tr> <td>支持部材に対する評価項目</td> <td>貫通評価及び支持機能評価</td> <td>貫通評価及び支持機能評価</td> <td>差異無し</td> </tr> </tbody> </table>	プラント	女川	(参考) 東海第二	相違理由	竜巻に対する設計の基本方針	竜巻飛来物防護対策設備は、竜巻防護ネット、防護網板等から構成し、飛来物から外部事象防護対象施設を防護できる設計とする。 (主とめ資料:1.8.2.1設計方針(1) 竜巻に対する設計の基本方針より抜粋)	竜巻飛来物防護対策設備は、防護ネット、防護網板等から構成し、飛来物から外部事象防護対象施設を防護できる設計とする。 【設備変更許可申請書（一部補正）1.7.2.1設計方針(1) 竜巻に対する設計の基本方針より抜粋】	差異無し	竜巻防護ネットの設計方針	竜巻防護ネットは、竜巻時及び竜巻通過後において、設計竜巻荷重及びその他考慮すべき荷重に対し、内包する非常用海水ポンプ等が安全機能を損なわないよう、設計飛来物が非常用海水ポンプ等に衝突することを防止可能な設計とする。 また、竜巻防護ネットは、その他考えられる自然現象に対して、非常用海水ポンプ等に波及的影響を及ぼさない設計とする。	防護対策施設は、竜巻時及び竜巻通過後において、設計竜巻荷重及びその他考慮すべき荷重に対し、内包する外部事象防護対象施設が安全機能を損なわないよう、設計飛来物等が外部事象防護対象施設に衝突することを防止可能な設計とする。 また、防護対策施設は、その他考えられる自然現象（地震等）に対して、外部事象防護対象施設に波及的影響を及ぼさない設計とする。 【工藤 V-1-1-2-3-1 竜巻への配慮に関する基本方針 2.1.3 竜巻の影響を考慮する施設の竜巻防護設計方針 c. 防護対策施設】	設備名称の相違	支持部材の設計方針	支持部材は設計竜巻の風圧力による荷重、飛来物による衝撃荷重及びその他の荷重に対し、飛来物が非常用海水ポンプ等へ衝突することを防止するために、飛来物が防護部材を構成する主要な構造部材を貫通せず、上載するネット及び防護板を支持する機能を維持可能な構造強度を有し、非常用海水ポンプ等に波及的影響を与えないために、支持部材を構成する部材自体の転倒及び脱落を生じない設計とする。	架橋は、設計竜巻の風圧力による荷重、飛来物による衝撃荷重及びその他の荷重に対し、飛来物が外部事象防護対象施設へ衝突することを防止するために、飛来物が架橋を構成する主要な構造部材を貫通せず、上載する防護ネット及び防護網板を支持する機能を維持可能な構造強度を有し、外部事象防護対象施設に波及的影響を与えないために、架橋を構成する部材自体の転倒及び脱落を生じない設計とする 【工藤 V-9-別添 1-2 防護対策施設の強度計算の方針 2.2 構造強度の設計方針 (3) 架橋】	部材名称の相違 設備名称の相違	支持機能を担持する部材	フレーム、大梁、ブACKET、ゴム支承、可動支承、ストッパ	架橋	支持構造の相違	支持部材に対する評価項目	貫通評価及び支持機能評価	貫通評価及び支持機能評価	差異無し		
プラント	女川	(参考) 東海第二	相違理由																								
竜巻に対する設計の基本方針	竜巻飛来物防護対策設備は、竜巻防護ネット、防護網板等から構成し、飛来物から外部事象防護対象施設を防護できる設計とする。 (主とめ資料:1.8.2.1設計方針(1) 竜巻に対する設計の基本方針より抜粋)	竜巻飛来物防護対策設備は、防護ネット、防護網板等から構成し、飛来物から外部事象防護対象施設を防護できる設計とする。 【設備変更許可申請書（一部補正）1.7.2.1設計方針(1) 竜巻に対する設計の基本方針より抜粋】	差異無し																								
竜巻防護ネットの設計方針	竜巻防護ネットは、竜巻時及び竜巻通過後において、設計竜巻荷重及びその他考慮すべき荷重に対し、内包する非常用海水ポンプ等が安全機能を損なわないよう、設計飛来物が非常用海水ポンプ等に衝突することを防止可能な設計とする。 また、竜巻防護ネットは、その他考えられる自然現象に対して、非常用海水ポンプ等に波及的影響を及ぼさない設計とする。	防護対策施設は、竜巻時及び竜巻通過後において、設計竜巻荷重及びその他考慮すべき荷重に対し、内包する外部事象防護対象施設が安全機能を損なわないよう、設計飛来物等が外部事象防護対象施設に衝突することを防止可能な設計とする。 また、防護対策施設は、その他考えられる自然現象（地震等）に対して、外部事象防護対象施設に波及的影響を及ぼさない設計とする。 【工藤 V-1-1-2-3-1 竜巻への配慮に関する基本方針 2.1.3 竜巻の影響を考慮する施設の竜巻防護設計方針 c. 防護対策施設】	設備名称の相違																								
支持部材の設計方針	支持部材は設計竜巻の風圧力による荷重、飛来物による衝撃荷重及びその他の荷重に対し、飛来物が非常用海水ポンプ等へ衝突することを防止するために、飛来物が防護部材を構成する主要な構造部材を貫通せず、上載するネット及び防護板を支持する機能を維持可能な構造強度を有し、非常用海水ポンプ等に波及的影響を与えないために、支持部材を構成する部材自体の転倒及び脱落を生じない設計とする。	架橋は、設計竜巻の風圧力による荷重、飛来物による衝撃荷重及びその他の荷重に対し、飛来物が外部事象防護対象施設へ衝突することを防止するために、飛来物が架橋を構成する主要な構造部材を貫通せず、上載する防護ネット及び防護網板を支持する機能を維持可能な構造強度を有し、外部事象防護対象施設に波及的影響を与えないために、架橋を構成する部材自体の転倒及び脱落を生じない設計とする 【工藤 V-9-別添 1-2 防護対策施設の強度計算の方針 2.2 構造強度の設計方針 (3) 架橋】	部材名称の相違 設備名称の相違																								
支持機能を担持する部材	フレーム、大梁、ブACKET、ゴム支承、可動支承、ストッパ	架橋	支持構造の相違																								
支持部材に対する評価項目	貫通評価及び支持機能評価	貫通評価及び支持機能評価	差異無し																								
	<p>女川2号炉の竜巻防護ネットは、先行プラントと支持構造に相違はあるが、「竜巻に対する設計の基本方針」、「竜巻防護ネットの設計方針」、「支持部材の設計方針」、「評価項目」に対して、先行プラントとの相違はないことを確認した。</p> <p style="text-align: right;">以上</p>		<p>【女川】</p> <ul style="list-style-type: none"> ・女川における別紙-1は、竜巻防護ネットの支持部材にゴム支承及び可動支承を介して支持したフレームに電中研で開発した竜巻防護ネットを固定する設置方法を採用したことによる設計方針の比較を目的とした資料と考えた。 ・泊の竜巻防護ネットは、先行プラント（大飯、高浜）と同様に鉄骨構造の架構に電中研で開発した竜巻防護ネットを固定して支持する方法を採用していることから、設計方針の比較は必要ないと考え、本資料は作成していない。 （竜巻防護ネットの強度計算結果は設工認で説明する方針） 																								

赤字：設備、運用又は体制の相違（設計方針の相違）
 青字：記載箇所又は記載内容の相違（記載方針の相違）
 緑字：記載表現、設備名称の相違（実質的な相違なし）

大飯発電所3/4号炉	女川原子力発電所2号炉	泊発電所3号炉	相違理由
	<p style="text-align: center;">別紙2</p> <p style="text-align: center;">支持部材の評価方法について</p> <p>1. 基本方針 設計飛来物がフレームに衝突した際の貫通評価及び支持機能評価は、フレーム及び設計飛来物である鋼製材をLS-DYNAによりモデル化し、衝突解析により実施する。 設計飛来物がフレームに衝突した際には可動支承を介して大梁、大梁ゴム支承ブラケット、ブラケットアンカーボルトに荷重が伝達されるため、LS-DYNAにより算出される可動支承に作用する反力を用いてDYNA2E（耐震評価と同様の解析モデル）により大梁、大梁ゴム支承、ブラケット、ブラケットアンカーボルトの応力評価を実施する。</p> <p>2. 解析モデル LS-DYNAにおけるモデル化対象はフレーム及び鋼製材とする。フレームゴム支承、可動支承は各STEPにおいて設定した結合条件を設定する。 LS-DYNAによる解析モデルを図1に示す。また、設計飛来物の鋼製材を図2に、鋼製材の緒元について、表1に示す。 DYNA2Eにおけるモデル化対象は耐震評価と同様とし、フレーム、大梁、フレームゴム支承、大梁ゴム支承、可動支承とする。各部材は梁要素でモデル化し、ゴム支承は線形ばね要素でモデル化する。解析モデルを図3に示す。なお、解析モデルの詳細は、詳細設計により変更もあり得る。</p> <p>3. 評価方法 LS-DYNAにより、フレームに設計飛来物が衝突した被衝突部に対し、ひずみ量を算出し、ひずみ量評価を実施する。 また、LS-DYNAにより可動支承の水平方向/鉛直上向き/鉛直下向きに作用するピーク反力を算出し、DYNA2Eの解析モデルに入力して、各部材の応力評価を実施する(図4参照)。フレームの位置により大梁以降に発生する応力が異なるため、DYNA2Eにて反力を入力するフレームは端部と中央に存在する2つを選定する。 飛来物衝突後の竜巻による風荷重に対して、フレームが落下しないことを確認するため、フレームゴム支承及び可動支承に対し、竜巻風荷重に対する支持機能評価を実施する。 評価条件は、飛来物衝突時の荷重にて、許容限界を超える部材が確認された支承については、飛来物衝突後に負荷される竜巻の風荷重を負担しないものとする。(風荷重による荷重が各支承に分散されない設定とすることで、残存する支承に対し厳しい評価となる。) また、竜巻による風荷重は、フレームの形状により決まる受圧面積と風力係数から算出し、風荷重が静的に負荷される条件で評価を実施する。 飛来物衝突後の風荷重に対する評価モデルを図5に示す。</p>		<p>【女川】</p> <ul style="list-style-type: none"> ・竜巻防護設備の構造の相違による資料の作成要否の相違。 ・女川は竜巻防護ネットを設置する海水ポンプエリアの壁が薄く支持機能に期待できないため、可動支承、ゴム支承を採用して地震により生じる応力を低減・分散させる構造として、ネットの支持機能を確保している。 ・泊においては、女川と異なり竜巻防護ネットは強固な建屋床面、ブラケットを介してピット壁面に設置できる環境であることから、女川で採用している可動式の機構を持たせる必要はない。 ・以上の理由から、泊の竜巻防護ネットは、先行プラント（大飯、高浜）と同様の竜巻防護ネットの構造を採用しており、架構に直接、竜巻防護ネットを設置する構造としている。 ・本資料は、ゴム支承及び可動支承を採用したことによる設計成立性に関する説明資料である。 ・泊では、ゴム支承等は使用していないことから、本資料は不要と判断し、作成していない。 <p>（竜巻防護ネットの強度計算結果は設工認で説明する方針）</p>

赤字：設備、運用又は体制の相違（設計方針の相違）
 青字：記載箇所又は記載内容の相違（記載方針の相違）
 緑字：記載表現、設備名称の相違（実質的な相違なし）

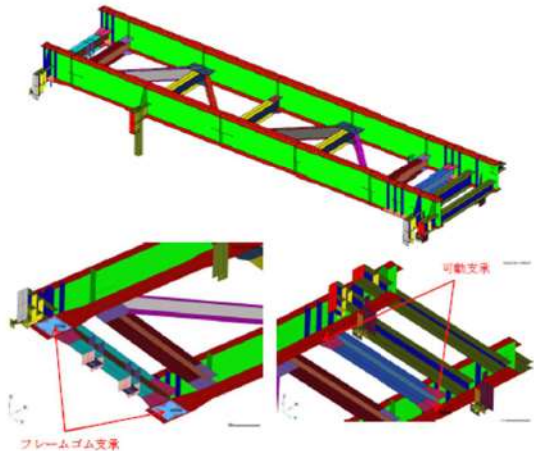
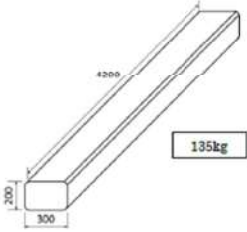
大飯発電所3/4号炉	女川原子力発電所2号炉	泊発電所3号炉	相違理由																						
	 <p>図1 LS-DYNA 解析モデル</p>  <p>図2 設計飛来物（鋼製材）</p> <p>表1 設計飛来物の諸元</p> <table border="1" data-bbox="723 1125 1279 1428"> <thead> <tr> <th>項目</th> <th>諸元</th> </tr> </thead> <tbody> <tr> <td>種類</td> <td>鋼製材</td> </tr> <tr> <td>形状(mm)</td> <td>200×300×4200</td> </tr> <tr> <td>重量(kg)</td> <td>135</td> </tr> <tr> <td>衝突速度(m/s)</td> <td>水平：46.6 鉛直：16.7</td> </tr> <tr> <td>要素タイプ</td> <td>シェル要素</td> </tr> <tr> <td>ひずみ速度依存性</td> <td>NEI07-13のDIF</td> </tr> <tr> <td>破断ひずみ</td> <td>0.14/TF, TF=1 (破断ひずみを超えても要素を消去しない)</td> </tr> <tr> <td>質量密度</td> <td>7.85 ton/m³</td> </tr> <tr> <td>縦弾性係数</td> <td>2.05×10⁵ N/mm²</td> </tr> <tr> <td>ポアソン比</td> <td>0.3</td> </tr> </tbody> </table>	項目	諸元	種類	鋼製材	形状(mm)	200×300×4200	重量(kg)	135	衝突速度(m/s)	水平：46.6 鉛直：16.7	要素タイプ	シェル要素	ひずみ速度依存性	NEI07-13のDIF	破断ひずみ	0.14/TF, TF=1 (破断ひずみを超えても要素を消去しない)	質量密度	7.85 ton/m ³	縦弾性係数	2.05×10 ⁵ N/mm ²	ポアソン比	0.3		
項目	諸元																								
種類	鋼製材																								
形状(mm)	200×300×4200																								
重量(kg)	135																								
衝突速度(m/s)	水平：46.6 鉛直：16.7																								
要素タイプ	シェル要素																								
ひずみ速度依存性	NEI07-13のDIF																								
破断ひずみ	0.14/TF, TF=1 (破断ひずみを超えても要素を消去しない)																								
質量密度	7.85 ton/m ³																								
縦弾性係数	2.05×10 ⁵ N/mm ²																								
ポアソン比	0.3																								

赤字：設備、運用又は体制の相違（設計方針の相違）
 青字：記載箇所又は記載内容の相違（記載方針の相違）
 緑字：記載表現、設備名称の相違（実質的な相違なし）

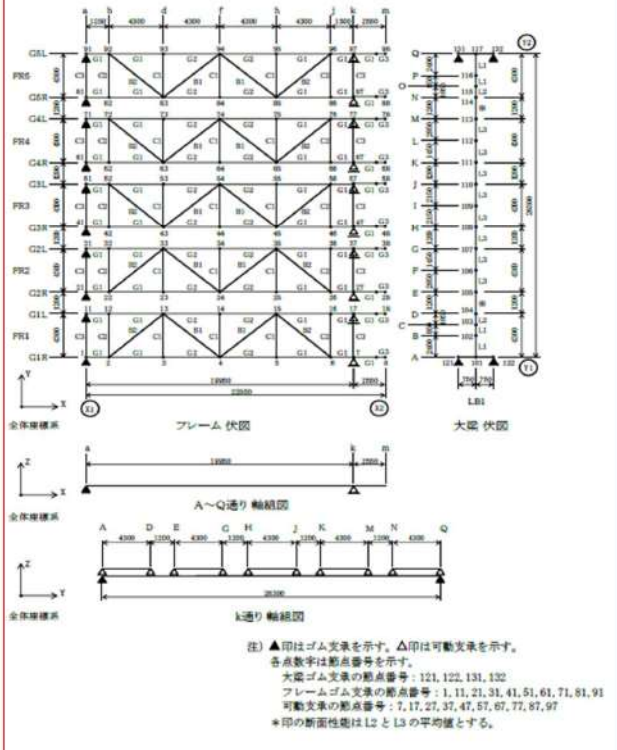
大飯発電所3/4号炉	女川原子力発電所2号炉	泊発電所3号炉	相違理由
	 <p>図3 DYNAGEの解析モデル図(1/2)</p>		

赤字：設備、運用又は体制の相違（設計方針の相違）
 青字：記載箇所又は記載内容の相違（記載方針の相違）
 緑字：記載表現、設備名称の相違（実質的な相違なし）

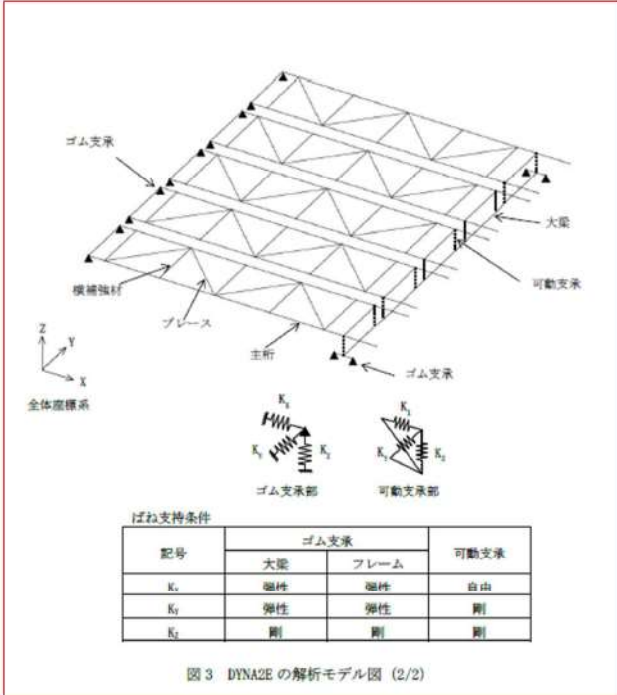
大飯発電所3/4号炉	女川原子力発電所2号炉	泊発電所3号炉	相違理由																		
	 <table border="1" data-bbox="831 730 1240 847"> <caption>ばね支持条件</caption> <thead> <tr> <th rowspan="2">記号</th> <th colspan="2">ゴム支承</th> <th rowspan="2">可動支承</th> </tr> <tr> <th>大梁</th> <th>ブレース</th> </tr> </thead> <tbody> <tr> <td>K_x</td> <td>弾性</td> <td>弾性</td> <td>自由</td> </tr> <tr> <td>K_y</td> <td>弾性</td> <td>弾性</td> <td>剛</td> </tr> <tr> <td>K_z</td> <td>剛</td> <td>剛</td> <td>剛</td> </tr> </tbody> </table> <p data-bbox="891 869 1135 890">図3 DYNAGEの解析モデル図 (2/2)</p>	記号	ゴム支承		可動支承	大梁	ブレース	K_x	弾性	弾性	自由	K_y	弾性	弾性	剛	K_z	剛	剛	剛		
記号	ゴム支承		可動支承																		
	大梁	ブレース																			
K_x	弾性	弾性	自由																		
K_y	弾性	弾性	剛																		
K_z	剛	剛	剛																		

赤字：設備、運用又は体制の相違（設計方針の相違）
 青字：記載箇所又は記載内容の相違（記載方針の相違）
 緑字：記載表現、設備名称の相違（実質的な相違なし）

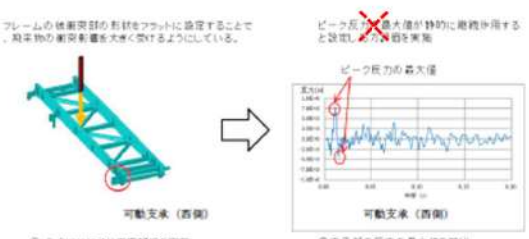
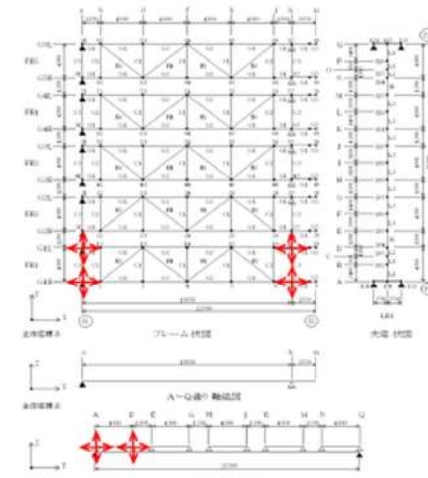
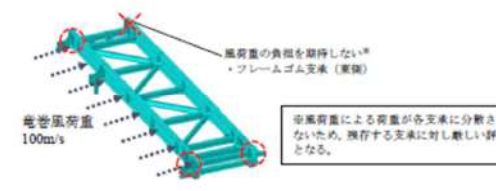
大飯発電所3/4号炉	女川原子力発電所2号炉	泊発電所3号炉	相違理由
	<p>フレームの接合部形状をフットに設定することで、飛来物の衝突衝撃を大きく受けやすくしている。</p> <p>ピーク応力が最大値が特的に増大すると設定し、その過を要案</p> <p>ピーク応力の最大値</p>  <p>可動支床（西側）</p> <p>DL5-DYNAによる衝突試験を実施</p> <p>◎主梁部の応力の最大値を算出</p>  <p>図4 応力等の算出方法（例）</p>  <p>風荷重の負担を期待しない* *フレームゴム支床（要案）</p> <p>竜巻風荷重 100m/s</p> <p>◎風荷重による荷重が各支床に分散されないため、残存する支床に対し厳しい評価となる。</p> <p>図5 飛来物衝突後の風荷重に対する評価モデル（イメージ）</p> <p>4. フレーム及び大梁の部材断面寸法</p> <p>表2に部材の断面寸法の一覧を示す。また、図6に断面寸法の記号説明図を示す。</p>		

赤字：設備、運用又は体制の相違（設計方針の相違）
 青字：記載箇所又は記載内容の相違（記載方針の相違）
 緑字：記載表現、設備名称の相違（実質的な相違なし）

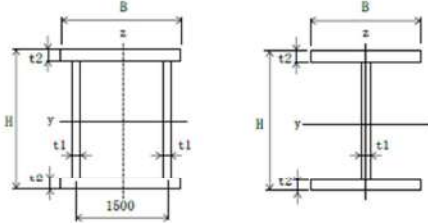
大飯発電所3/4号炉	女川原子力発電所2号炉	泊発電所3号炉	相違理由																																																																																																	
	<div data-bbox="712 209 1326 954" style="border: 1px solid red; padding: 5px;"> <p style="text-align: center;">表2 部材断面寸法</p> <table border="1" style="width: 100%; border-collapse: collapse; text-align: center;"> <thead> <tr> <th rowspan="2">部材</th> <th rowspan="2">記号</th> <th rowspan="2">材質</th> <th colspan="4">断面寸法 (mm)</th> </tr> <tr> <th>H</th> <th>B</th> <th>t1</th> <th>t2</th> </tr> </thead> <tbody> <tr> <td rowspan="3">大梁</td> <td>L1</td> <td>SM490A</td> <td>1300</td> <td>1580</td> <td>32</td> <td>40</td> </tr> <tr> <td>L2</td> <td>SM520B</td> <td>1300</td> <td>1580</td> <td>40</td> <td>40</td> </tr> <tr> <td>L3</td> <td>SM520B</td> <td>1500</td> <td>1580</td> <td>40</td> <td>40</td> </tr> <tr> <td rowspan="9">フレーム</td> <td rowspan="3">主桁</td> <td>G1</td> <td>SM490A</td> <td>1000</td> <td>450</td> <td>19</td> <td>25</td> </tr> <tr> <td>G2</td> <td>SM490A</td> <td>1000</td> <td>560</td> <td>19</td> <td>25</td> </tr> <tr> <td>G3</td> <td>SM490A</td> <td>900</td> <td>450</td> <td>19</td> <td>25</td> </tr> <tr> <td rowspan="3">横補強材</td> <td>C1</td> <td>SM400A</td> <td>400</td> <td>400</td> <td>19</td> <td>22</td> </tr> <tr> <td>C2</td> <td>SM490A</td> <td>400</td> <td>400</td> <td>19</td> <td>22</td> </tr> <tr> <td>C3</td> <td>SM490A</td> <td>400</td> <td>400</td> <td>19</td> <td>25</td> </tr> <tr> <td rowspan="2">ブレース</td> <td>B1</td> <td>SS400</td> <td>400</td> <td>200</td> <td>8</td> <td>13</td> </tr> <tr> <td>B2</td> <td>SM400A</td> <td>400</td> <td>200</td> <td>9</td> <td>22</td> </tr> </tbody> </table>  <p style="text-align: center;">(a) 大梁 (b) 主桁、横補強材、ブレース</p> <p style="text-align: center;">図6 部材断面寸法の記号説明図</p> </div>	部材	記号	材質	断面寸法 (mm)				H	B	t1	t2	大梁	L1	SM490A	1300	1580	32	40	L2	SM520B	1300	1580	40	40	L3	SM520B	1500	1580	40	40	フレーム	主桁	G1	SM490A	1000	450	19	25	G2	SM490A	1000	560	19	25	G3	SM490A	900	450	19	25	横補強材	C1	SM400A	400	400	19	22	C2	SM490A	400	400	19	22	C3	SM490A	400	400	19	25	ブレース	B1	SS400	400	200	8	13	B2	SM400A	400	200	9	22																	
部材	記号				材質	断面寸法 (mm)																																																																																														
		H	B	t1		t2																																																																																														
大梁	L1	SM490A	1300	1580	32	40																																																																																														
	L2	SM520B	1300	1580	40	40																																																																																														
	L3	SM520B	1500	1580	40	40																																																																																														
フレーム	主桁	G1	SM490A	1000	450	19	25																																																																																													
		G2	SM490A	1000	560	19	25																																																																																													
		G3	SM490A	900	450	19	25																																																																																													
	横補強材	C1	SM400A	400	400	19	22																																																																																													
		C2	SM490A	400	400	19	22																																																																																													
		C3	SM490A	400	400	19	25																																																																																													
	ブレース	B1	SS400	400	200	8	13																																																																																													
		B2	SM400A	400	200	9	22																																																																																													
		<div data-bbox="712 991 1267 1453" style="border: 1px solid red; padding: 5px;"> <p>5. フレーム及び大梁の部材剛性</p> <p>表3に解析に用いる部材剛性の一覧を示す。</p> <table border="1" style="width: 100%; border-collapse: collapse; text-align: center;"> <thead> <tr> <th colspan="7">表3 部材剛性</th> </tr> <tr> <th>部材</th> <th>記号</th> <th>A (cm²)</th> <th>I_z (cm⁴)</th> <th>I_y (cm⁴)</th> <th>I_x (cm⁴)</th> <th>As_y (cm²)</th> <th>As_z (cm²)</th> </tr> </thead> <tbody> <tr> <td rowspan="3">大梁</td> <td>L1</td> <td>2,045</td> <td>7,020,000</td> <td>5,990,000</td> <td>9,300,000</td> <td>1,264</td> <td>780.8</td> </tr> <tr> <td>L2</td> <td>2,240</td> <td>8,120,000</td> <td>6,230,000</td> <td>10,400,000</td> <td>1,264</td> <td>976.0</td> </tr> <tr> <td>L3</td> <td>2,400</td> <td>9,020,000</td> <td>8,650,000</td> <td>13,000,000</td> <td>1,264</td> <td>1,136</td> </tr> <tr> <td rowspan="9">フレーム</td> <td rowspan="3">主桁</td> <td>G1</td> <td>405.5</td> <td>38,000</td> <td>671,000</td> <td>688</td> <td>225.0</td> <td>180.5</td> </tr> <tr> <td>G2</td> <td>460.5</td> <td>73,200</td> <td>801,000</td> <td>801</td> <td>280.0</td> <td>180.5</td> </tr> <tr> <td>G3</td> <td>386.5</td> <td>38,000</td> <td>528,000</td> <td>663</td> <td>225.0</td> <td>161.5</td> </tr> <tr> <td rowspan="3">横補強材</td> <td>C1</td> <td>243.6</td> <td>23,500</td> <td>70,100</td> <td>365</td> <td>176.0</td> <td>67.64</td> </tr> <tr> <td>C2</td> <td>243.6</td> <td>23,500</td> <td>70,100</td> <td>365</td> <td>176.0</td> <td>67.64</td> </tr> <tr> <td>C3</td> <td>286.5</td> <td>28,700</td> <td>77,200</td> <td>497</td> <td>200.0</td> <td>66.50</td> </tr> <tr> <td rowspan="2">ブレース</td> <td>B1</td> <td>83.37</td> <td>-</td> <td>-</td> <td>-</td> <td>-</td> <td>-</td> </tr> <tr> <td>B2</td> <td>120.0</td> <td>-</td> <td>-</td> <td>-</td> <td>-</td> <td>-</td> </tr> </tbody> </table> <p>A：断面積 I_z：部材z軸周りの断面2次モーメント I_y：部材y軸周りの断面2次モーメント I_x：ねじり剛性 As_y：部材y軸方向のせん断面積 As_z：部材z軸方向のせん断面積 部材軸方向の定義は図2に示すとおりである。</p> </div>	表3 部材剛性							部材	記号	A (cm ²)	I _z (cm ⁴)	I _y (cm ⁴)	I _x (cm ⁴)	As _y (cm ²)	As _z (cm ²)	大梁	L1	2,045	7,020,000	5,990,000	9,300,000	1,264	780.8	L2	2,240	8,120,000	6,230,000	10,400,000	1,264	976.0	L3	2,400	9,020,000	8,650,000	13,000,000	1,264	1,136	フレーム	主桁	G1	405.5	38,000	671,000	688	225.0	180.5	G2	460.5	73,200	801,000	801	280.0	180.5	G3	386.5	38,000	528,000	663	225.0	161.5	横補強材	C1	243.6	23,500	70,100	365	176.0	67.64	C2	243.6	23,500	70,100	365	176.0	67.64	C3	286.5	28,700	77,200	497	200.0	66.50	ブレース	B1	83.37	-	-	-	-	-	B2	120.0	-	-	-	-	-	
表3 部材剛性																																																																																																				
部材	記号	A (cm ²)	I _z (cm ⁴)	I _y (cm ⁴)	I _x (cm ⁴)	As _y (cm ²)	As _z (cm ²)																																																																																													
大梁	L1	2,045	7,020,000	5,990,000	9,300,000	1,264	780.8																																																																																													
	L2	2,240	8,120,000	6,230,000	10,400,000	1,264	976.0																																																																																													
	L3	2,400	9,020,000	8,650,000	13,000,000	1,264	1,136																																																																																													
フレーム	主桁	G1	405.5	38,000	671,000	688	225.0	180.5																																																																																												
		G2	460.5	73,200	801,000	801	280.0	180.5																																																																																												
		G3	386.5	38,000	528,000	663	225.0	161.5																																																																																												
	横補強材	C1	243.6	23,500	70,100	365	176.0	67.64																																																																																												
		C2	243.6	23,500	70,100	365	176.0	67.64																																																																																												
		C3	286.5	28,700	77,200	497	200.0	66.50																																																																																												
	ブレース	B1	83.37	-	-	-	-	-																																																																																												
		B2	120.0	-	-	-	-	-																																																																																												

赤字：設備、運用又は体制の相違（設計方針の相違）
 青字：記載箇所又は記載内容の相違（記載方針の相違）
 緑字：記載表現、設備名称の相違（実質的な相違なし）

大飯発電所3/4号炉	女川原子力発電所2号炉	泊発電所3号炉	相違理由																																																																														
	<p>6. 材料定数 鋼材の材料定数を表4に示す。</p> <table border="1" data-bbox="712 260 1299 392"> <caption>表4 鋼材の材料定数</caption> <thead> <tr> <th>材料</th> <th>ヤング率 (N/mm²)</th> <th>ポアソン比</th> </tr> </thead> <tbody> <tr> <td>鋼材</td> <td>2.03×10⁵</td> <td>0.3</td> </tr> </tbody> </table> <p>7. ゴム支承及び可動支承の仕様 ゴム支承の設計仕様を表5に示す。 可動支承の設計仕様を表6に示す。</p> <table border="1" data-bbox="712 528 1328 866"> <caption>表5 ゴム支承の設計仕様</caption> <thead> <tr> <th rowspan="2">項目</th> <th>ブラケット</th> <th>フレーム/隔壁</th> </tr> <tr> <th>接続部</th> <th>接続部</th> </tr> </thead> <tbody> <tr> <td>支承種類</td> <td colspan="2">地震時水平力分散型ゴム支承</td> </tr> <tr> <td>ゴム体種類</td> <td colspan="2">天然ゴム(NR)</td> </tr> <tr> <td>ゴム体有効平面寸法(mm)</td> <td>800×800</td> <td>550×550</td> </tr> <tr> <td>総ゴム厚(mm)</td> <td>192</td> <td>135</td> </tr> <tr> <td>(ゴム厚(mm)×層数)</td> <td>(24×8層)</td> <td>(15×9層)</td> </tr> <tr> <td>せん断弾性係数(N/mm²)</td> <td>1.0(G10)</td> <td>1.2(G12)</td> </tr> <tr> <td>一次形状係数</td> <td>8.33</td> <td>9.17</td> </tr> <tr> <td>二次形状係数</td> <td>4.17</td> <td>4.07</td> </tr> <tr> <td>水平剛性(kN/mm)</td> <td>3.333</td> <td>2.689</td> </tr> <tr> <td>鉛直剛性(kN/mm)</td> <td>972</td> <td>863</td> </tr> </tbody> </table> <table border="1" data-bbox="712 887 1328 1281"> <caption>表6 可動支承の設計仕様</caption> <thead> <tr> <th rowspan="2">項目</th> <th rowspan="2">材質</th> <th colspan="3">仕様</th> </tr> <tr> <th>配合</th> <th>物性値</th> <th>表面粗さ</th> </tr> </thead> <tbody> <tr> <td rowspan="6">すべり材</td> <td rowspan="6">ポリアミド MC703HL</td> <td rowspan="2">配合</td> <td>ポリアミド樹脂</td> <td>90%以上</td> </tr> <tr> <td>固形潤滑材</td> <td>10%以下</td> </tr> <tr> <td rowspan="4">物性値</td> <td>引張強度(N/mm²)</td> <td>60~70 ASTM D-638</td> </tr> <tr> <td>伸び(%)</td> <td>15~25 ASTM D-638</td> </tr> <tr> <td>比重</td> <td>1.11</td> </tr> <tr> <td>表面粗さ</td> <td>Rz 25μ以下</td> </tr> <tr> <td rowspan="2">ステンレス SUS304 SUS316</td> <td>材料規格</td> <td>JIS G 4304 JIS G 4305</td> </tr> <tr> <td>表面処理</td> <td>JIS G 4305 No2B</td> </tr> <tr> <td>圧縮ゴム</td> <td>クロロプレン 系合成ゴム C08</td> <td>材料規格</td> <td>JIS K 6383</td> </tr> <tr> <td rowspan="2">鋼材 (ピストン ベースポッド レール等)</td> <td rowspan="2">SS400 SM490</td> <td rowspan="2">材料規格</td> <td>JIS G 3101 JIS G 3106</td> </tr> </tbody> </table> <p>8. 各部の評価方法 (1)大梁及びブラケットの応力評価 大梁及びブラケットの断面評価は次式によって行う。 鋼材の基準強度及び式中の各許容応力の算出方法を(a)~(e)に示す。</p>	材料	ヤング率 (N/mm ²)	ポアソン比	鋼材	2.03×10 ⁵	0.3	項目	ブラケット	フレーム/隔壁	接続部	接続部	支承種類	地震時水平力分散型ゴム支承		ゴム体種類	天然ゴム(NR)		ゴム体有効平面寸法(mm)	800×800	550×550	総ゴム厚(mm)	192	135	(ゴム厚(mm)×層数)	(24×8層)	(15×9層)	せん断弾性係数(N/mm ²)	1.0(G10)	1.2(G12)	一次形状係数	8.33	9.17	二次形状係数	4.17	4.07	水平剛性(kN/mm)	3.333	2.689	鉛直剛性(kN/mm)	972	863	項目	材質	仕様			配合	物性値	表面粗さ	すべり材	ポリアミド MC703HL	配合	ポリアミド樹脂	90%以上	固形潤滑材	10%以下	物性値	引張強度(N/mm ²)	60~70 ASTM D-638	伸び(%)	15~25 ASTM D-638	比重	1.11	表面粗さ	Rz 25μ以下	ステンレス SUS304 SUS316	材料規格	JIS G 4304 JIS G 4305	表面処理	JIS G 4305 No2B	圧縮ゴム	クロロプレン 系合成ゴム C08	材料規格	JIS K 6383	鋼材 (ピストン ベースポッド レール等)	SS400 SM490	材料規格	JIS G 3101 JIS G 3106		
材料	ヤング率 (N/mm ²)	ポアソン比																																																																															
鋼材	2.03×10 ⁵	0.3																																																																															
項目	ブラケット	フレーム/隔壁																																																																															
	接続部	接続部																																																																															
支承種類	地震時水平力分散型ゴム支承																																																																																
ゴム体種類	天然ゴム(NR)																																																																																
ゴム体有効平面寸法(mm)	800×800	550×550																																																																															
総ゴム厚(mm)	192	135																																																																															
(ゴム厚(mm)×層数)	(24×8層)	(15×9層)																																																																															
せん断弾性係数(N/mm ²)	1.0(G10)	1.2(G12)																																																																															
一次形状係数	8.33	9.17																																																																															
二次形状係数	4.17	4.07																																																																															
水平剛性(kN/mm)	3.333	2.689																																																																															
鉛直剛性(kN/mm)	972	863																																																																															
項目	材質	仕様																																																																															
		配合	物性値	表面粗さ																																																																													
すべり材	ポリアミド MC703HL	配合	ポリアミド樹脂	90%以上																																																																													
			固形潤滑材	10%以下																																																																													
		物性値	引張強度(N/mm ²)	60~70 ASTM D-638																																																																													
			伸び(%)	15~25 ASTM D-638																																																																													
			比重	1.11																																																																													
			表面粗さ	Rz 25μ以下																																																																													
ステンレス SUS304 SUS316	材料規格	JIS G 4304 JIS G 4305																																																																															
	表面処理	JIS G 4305 No2B																																																																															
圧縮ゴム	クロロプレン 系合成ゴム C08	材料規格	JIS K 6383																																																																														
鋼材 (ピストン ベースポッド レール等)	SS400 SM490	材料規格	JIS G 3101 JIS G 3106																																																																														

赤字：設備、運用又は体制の相違（設計方針の相違）
 青字：記載箇所又は記載内容の相違（記載方針の相違）
 緑字：記載表現、設備名称の相違（実質的な相違なし）

大飯発電所3/4号炉	女川原子力発電所2号炉	泊発電所3号炉	相違理由																				
	<div style="border: 1px solid red; padding: 5px;"> <p>・圧縮応力と部材y, z軸（図6参照）周りの曲げ応力の組合せ評価</p> $\frac{\sigma_c}{f_c} + \frac{\sigma_{by}}{f_{by}} + \frac{\sigma_{bz}}{f_{bz}} \leq 1$ <p>・せん断応力の評価</p> $\tau \leq f_s$ <p>・垂直応力とせん断応力の組合せ評価</p> $\sqrt{\sigma_x^2 + \sigma_y^2 - \sigma_x \sigma_y + 3\tau^2} \leq f_t$ <p>σ_c : 圧縮応力 $\sigma_c = N/A$ N : 軸力 A : 断面積 σ_{by} : 部材y軸周りの曲げ応力 $\sigma_{by} = M_y/Z_y$ M_y : 部材y軸周りの曲げモーメント Z_y : 部材y軸周りの断面係数 σ_{bz} : 部材z軸周りの曲げ応力 $\sigma_{bz} = M_z/Z_z$ M_z : 部材z軸周りの曲げモーメント Z_z : 部材z軸周りの断面係数 τ : せん断応力 $\tau = Q/A$ Q : せん断力 A : せん断断面積 σ_x, σ_y : 互いに直交する垂直応力 τ_{xy} : σ_x, σ_yの作用する面内せん断応力 f_c : 許容圧縮応力 f_{by} : 部材y軸周りの許容曲げ応力 f_{bz} : 部材z軸周りの許容曲げ応力 f_s : 許容せん断応力 f_t : 許容引張応力</p> </div> <p>(a) 鋼材の基準強度</p> <p>次の計算式により算出した値とする。表7に使用鋼材の設計降伏点S_y及び設計引張強さS_uを示す。</p> <div style="border: 1px solid red; padding: 5px; margin-top: 10px;"> $F = \text{MIN} (1.2S_y, 0.7S_u)$ <p>F : 鋼材の基準強度 (MPa) S_y : 「発電用原子力設備規格 設計・建設規格 (JSME S NC1-2005/2007)」に規定される鋼材の設計降伏点 (MPa) S_u : 「発電用原子力設備規格 設計・建設規格 (JSME S NC1-2005/2007)」に規定される鋼材の設計引張強さ (MPa)</p> </div> <div style="border: 1px solid red; padding: 5px; margin-top: 10px;"> <p style="text-align: center;">表7 使用鋼材の設計降伏点及び設計引張強さ</p> <table border="1" style="width: 100%; border-collapse: collapse;"> <thead> <tr> <th>鋼材の種類</th> <th>評価用温度 (°C)</th> <th>板厚 t (mm)</th> <th>設計降伏点 S_y (MPa)</th> <th>設計引張強さ S_u (MPa)</th> </tr> </thead> <tbody> <tr> <td>SS400, SM400A</td> <td>40</td> <td>t ≤ 40</td> <td>235</td> <td>400</td> </tr> <tr> <td>SM490A</td> <td>40</td> <td>t ≤ 40</td> <td>315</td> <td>490</td> </tr> <tr> <td>SM520B</td> <td>40</td> <td>t ≤ 40</td> <td>355</td> <td>520</td> </tr> </tbody> </table> </div>	鋼材の種類	評価用温度 (°C)	板厚 t (mm)	設計降伏点 S_y (MPa)	設計引張強さ S_u (MPa)	SS400, SM400A	40	t ≤ 40	235	400	SM490A	40	t ≤ 40	315	490	SM520B	40	t ≤ 40	355	520		
鋼材の種類	評価用温度 (°C)	板厚 t (mm)	設計降伏点 S_y (MPa)	設計引張強さ S_u (MPa)																			
SS400, SM400A	40	t ≤ 40	235	400																			
SM490A	40	t ≤ 40	315	490																			
SM520B	40	t ≤ 40	355	520																			

赤字：設備、運用又は体制の相違（設計方針の相違）
 青字：記載箇所又は記載内容の相違（記載方針の相違）
 緑字：記載表現、設備名称の相違（実質的な相違なし）

大飯発電所3/4号炉	女川原子力発電所2号炉	泊発電所3号炉	相違理由
	<p>(b) 許容引張応力 次の計算式により算出した値とする。</p> $f_t = 1.5 \cdot \frac{F}{1.5}$ <p>f_t：許容引張応力 (MPa)</p> <p>(c) 許容せん断応力 次の計算式により算出した値とする。</p> $f_s = 1.5 \cdot \frac{F}{1.5\sqrt{3}}$ <p>f_s：許容せん断応力 (MPa)</p> <p>(d) 許容圧縮応力 次の計算式により算出した値とする。</p> <p>i) 圧縮材の有効細長比が限界細長比以下の場合</p> $f_c = 1.5 \cdot \left\{ 1 - 0.4 \left(\frac{\lambda}{\Lambda} \right)^2 \right\} \frac{F}{v}$ $\lambda = \frac{\ell_k}{i} \quad \Lambda = \sqrt{\frac{\pi^2 E}{0.6F}} \quad v = 1.5 + \frac{2}{3} \left(\frac{\lambda}{\Lambda} \right)^2$ <p>f_c：許容圧縮応力 (MPa) λ：有効細長比 Λ：限界細長比 v：安全率 ℓ_k：座屈長さ (mm) i：座屈軸についての断面二次半径 (mm) E：縦弾性係数 (ヤング係数) (MPa)</p> <p>ii) 圧縮材の有効細長比が限界細長比を超える場合</p> $f_c = 1.5 \cdot 0.277F \left(\frac{\Lambda}{\lambda} \right)^2$		

(e) 許容曲げ応力
 次の計算式により算出した値とする。

i) 荷重面内に対称軸を有する圧延形鋼及び溶接組立鋼であって強軸周りに曲げを受けるもの（箱形断面のものを除く）。

次の2つの計算式により計算した値のうちいずれか大きい方の値又は f_t のいずれか小さい方の値とする。

$$f_b = 1.5 \cdot \left\{ 1 - 0.4 \frac{e_b^2}{C A^2 I^2} \right\} f_t$$

$$f_b = 1.5 \cdot \frac{0.433 E A_f}{e_b h}$$

ここに、

- f_b : 許容曲げ応力 (MPa)
- e_b : 圧縮フランジの支点間距離 (mm)
- h : はりのせい (mm)
- A_f : 圧縮フランジの断面積 (mm²)
- i : 圧縮フランジとはりのせいの6分の1とからなるT型断面のウェブ軸周りの断面二次半径 (mm)
- C : 次の計算式により計算した値又は2.3のうちいずれか小さい方の値（ただし、座屈区間中間の強軸まわりの曲げモーメントが M_1 より大きい場合は、1とする）

$$c = 1.75 + 1.05 \left(\frac{M_2}{M_1} \right) + 0.3 \left(\frac{M_2}{M_1} \right)^2$$

M_1, M_2 : それぞれ座屈区間端部における強軸周りの曲げモーメント。この場合において、 M_2/M_1 は1より小さいものとし、単曲率の場合を負に、複曲率の場合を正とする。

ii) 荷重面内に対称軸を有する圧延形鋼及び溶接組立鋼であって弱軸周りに曲げを受けるもの、面内に曲げを受けるガゼットプレート、曲げを受ける鋼管及び箱形断面の場合は f_t とする。

赤字：設備、運用又は体制の相違（設計方針の相違）
 青字：記載箇所又は記載内容の相違（記載方針の相違）
 緑字：記載表現、設備名称の相違（実質的な相違なし）

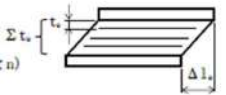
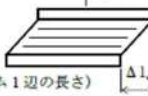
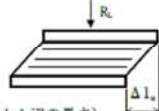
大飯発電所3/4号炉	女川原子力発電所2号炉	泊発電所3号炉	相違理由
	<p>(2) ゴム支承の評価</p> <p>(a) せん断ひずみの評価</p> <p>i) せん断ひずみの評価式</p> <p>水平力支持機能は、発生するせん断ひずみが許容せん断ひずみを超えないことを確認する。次式によって、水平変位量を総ゴム厚で除して求めたゴムのせん断ひずみを評価する。</p> $\gamma = \Delta l / \Sigma t \leq \gamma_{sa}$ <p>ここに、</p> <ul style="list-style-type: none"> γ：せん断ひずみ Δl：水平変位量 Σt：総ゴム厚（=ゴム1層厚 t × 層数 n） γ_{sa}：せん断ひずみの許容値  <p>ii) 引張応力の評価式</p> <p>地震時の上向きの力によって生じる引張応力を次式によって評価する。</p> $\sigma_{sa} = R_u / A_{sa} \leq \sigma_{sa}$ <p>ここに、</p> <ul style="list-style-type: none"> σ_{sa}：引張応力 R_u：上向きの反力 A_{sa}：移動量を控除した引張に有効な面積 $A_{sa} = A_u - B \cdot \Delta l$（$B$：有効幅、ゴム支承の積層ゴム1辺の長さ） σ_{sa}：引張応力の許容値  <p>(b) 座屈安定性の評価</p> <p>i) 座屈安定性の評価式</p> <p>圧縮力が作用したときゴム支承本体の座屈に対して安全でなければならない。座屈安定性は地震時のせん断変形時における圧縮に有効な面積より算出した圧縮応力により評価する。次式により座屈に対する安全性を確認する。</p> $\sigma_{sa} = R_c / A_{sa} \leq \sigma_{sa}$ <p>ここに、</p> <ul style="list-style-type: none"> σ_{sa}：圧縮応力 R_c：下向きの反力 A_{sa}：移動量を控除した圧縮に有効な面積 $A_{sa} = A_u - B \cdot \Delta l$（$B$：有効幅、ゴム支承の積層ゴム1辺の長さ） σ_{sa}：道路橋支保便覧に定める座屈を考慮した圧縮応力の許容値 		

赤字：設備、運用又は体制の相違（設計方針の相違）
 青字：記載箇所又は記載内容の相違（記載方針の相違）
 緑字：記載表現、設備名称の相違（実質的な相違なし）

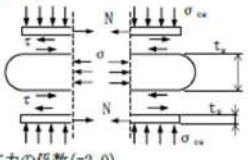
大飯発電所3/4号炉	女川原子力発電所2号炉	泊発電所3号炉	相違理由
	<p>(c) 圧縮応力の許容値 座屈を考慮した圧縮応力の許容値は次式より求める。 $\sigma_{ca} = G_c \cdot S_1 \cdot S_2 / f_{ca}$ ここに、 S_1 : ゴム支承の一次形状係数 $S_1 = A_w / (4 \cdot B \cdot t_g)$ S_2 : ゴム支承の二次形状係数 $S_2 = B / \Sigma t_g$ f_{ca} : 荷重の大きさ及び発生頻度を考慮した係数</p> <p>(3) 内部鋼板の引張応力の評価 (a) 内部鋼板の評価式 ゴム支承に補強材として使用する内部鋼板には、下図のように鉛直荷重によって水平方向への引張力Nが発生する。圧縮力が作用したときゴム支承の内部鋼板に生じる引張応力を次式により評価する。</p> <div style="display: flex; align-items: center;"> <div style="flex: 1;"> <p>$\sigma_s = f_s \cdot \sigma_{ca} \cdot t_s / t_g \leq f_t$ ここに σ_s : 内部鋼板の引張応力 σ_{ca} : 圧縮応力 t_g : ゴム層の厚さ t_s : 内部鋼板の厚さ f_s : 圧縮応力の分布を考慮した引張応力の係数(=2.0) f_t : 鋼材の許容引張応力</p> </div> <div style="flex: 1;">  </div> </div> <p>内部鋼板の引張応力の算出にあたっては、圧縮応力を静的荷重として内部鋼板の引張応力を求めている。ゴム支承平面内の圧縮応力分布を考慮して、実験より最大応力と平均応力の比を確認して係数 f_s が設定されている。</p> <p>(4) ボルト材の応力評価 (a) 許容引張応力 次の計算式により算出した値とする。 $f_t = 1.5 \frac{F}{2}$ f_t : 許容引張応力 (MPa) F : 9. (1) (a) に定めるところによる。Sy, SuはJIS規格による降伏点、引張強さとする。ボルトの使用材料と降伏点及び引張強さは表8のとおりである。</p>		

赤字：設備、運用又は体制の相違（設計方針の相違）
 青字：記載箇所又は記載内容の相違（記載方針の相違）
 緑字：記載表現、設備名称の相違（実質的な相違なし）

大飯発電所3/4号炉	女川原子力発電所2号炉	泊発電所3号炉	相違理由																																																						
	<p>表8 ボルトの使用材料とJIS規格による降伏点及び引張強さ</p> <table border="1" data-bbox="721 185 1308 277"> <thead> <tr> <th>部位</th> <th>材料</th> <th>降伏点 (MPa)</th> <th>引張強さ (MPa)</th> </tr> </thead> <tbody> <tr> <td>アンカーボルト</td> <td>SD390</td> <td>390</td> <td>560</td> </tr> <tr> <td>ゴム支承受付ボルト</td> <td>JIS 強度区分 8.8</td> <td>640</td> <td>800</td> </tr> </tbody> </table> <p>(b) 許容せん断応力 次の計算式により算出した値とする。 $f_s = 1.5 \cdot \frac{F}{1.5\sqrt{3}}$ f_s : 許容せん断応力 (MPa)</p> <p>(c) 引張応力とせん断応力を同時に受けるボルトの許容引張応力 せん断応力と引張応力を同時に受けるボルトの許容引張応力f_{ts}は、次のいずれか小さい方の値とする。 (i) $f_{ts} = 1.4f_{ts} - 1.6\tau$ (ii) $f_{ts} = f_{ts}$ f_{ts} : せん断力を同時に受けるボルトの許容引張応力 (MPa) f_{ts} : (a)で規定するボルトの引張応力 (MPa) τ : ボルトに作用するせん断応力 (MPa)</p> <p>(5) 可動支承の評価 竜巻防護ネットの設計における可動支承の評価項目を表9及び図7に示す。</p> <p>表9 可動支承評価項目</p> <table border="1" data-bbox="721 724 1323 1091"> <thead> <tr> <th>評価部位</th> <th>作用力</th> <th>評価項目</th> </tr> </thead> <tbody> <tr> <td>①すべり材</td> <td>鉛直力（下向き）</td> <td>支圧</td> </tr> <tr> <td>②ピストン</td> <td>鉛直力（下向き）</td> <td>曲げ</td> </tr> <tr> <td>③圧縮ゴム</td> <td>鉛直力（下向き）</td> <td>支圧</td> </tr> <tr> <td>④塵金</td> <td>鉛直力（下向き）</td> <td>支圧</td> </tr> <tr> <td>⑤ベースポット突出部</td> <td>上揚力</td> <td>曲げ、せん断、支圧</td> </tr> <tr> <td>⑥レール</td> <td>上揚力、水平力</td> <td>曲げ、引張、せん断</td> </tr> <tr> <td>⑦レール取付ボルト</td> <td>上揚力、水平力</td> <td>引張、せん断</td> </tr> <tr> <td>⑧エンドプレート接合ボルト</td> <td>上揚力、水平力</td> <td>引張</td> </tr> <tr> <td>⑨ベースポット支圧部</td> <td>水平力</td> <td>支圧</td> </tr> <tr> <td>⑩上部接合ボルト</td> <td>上揚力、水平力</td> <td>引張、せん断</td> </tr> <tr> <td>⑪下部接合ボルト</td> <td>上揚力、水平力</td> <td>引張、せん断</td> </tr> <tr> <td>⑫ベースプレート</td> <td>上揚力、水平力</td> <td>曲げ、せん断</td> </tr> <tr> <td>⑬ソールプレート(上板)</td> <td>鉛直力(下向き)</td> <td>支圧</td> </tr> </tbody> </table>	部位	材料	降伏点 (MPa)	引張強さ (MPa)	アンカーボルト	SD390	390	560	ゴム支承受付ボルト	JIS 強度区分 8.8	640	800	評価部位	作用力	評価項目	①すべり材	鉛直力（下向き）	支圧	②ピストン	鉛直力（下向き）	曲げ	③圧縮ゴム	鉛直力（下向き）	支圧	④塵金	鉛直力（下向き）	支圧	⑤ベースポット突出部	上揚力	曲げ、せん断、支圧	⑥レール	上揚力、水平力	曲げ、引張、せん断	⑦レール取付ボルト	上揚力、水平力	引張、せん断	⑧エンドプレート接合ボルト	上揚力、水平力	引張	⑨ベースポット支圧部	水平力	支圧	⑩上部接合ボルト	上揚力、水平力	引張、せん断	⑪下部接合ボルト	上揚力、水平力	引張、せん断	⑫ベースプレート	上揚力、水平力	曲げ、せん断	⑬ソールプレート(上板)	鉛直力(下向き)	支圧		
部位	材料	降伏点 (MPa)	引張強さ (MPa)																																																						
アンカーボルト	SD390	390	560																																																						
ゴム支承受付ボルト	JIS 強度区分 8.8	640	800																																																						
評価部位	作用力	評価項目																																																							
①すべり材	鉛直力（下向き）	支圧																																																							
②ピストン	鉛直力（下向き）	曲げ																																																							
③圧縮ゴム	鉛直力（下向き）	支圧																																																							
④塵金	鉛直力（下向き）	支圧																																																							
⑤ベースポット突出部	上揚力	曲げ、せん断、支圧																																																							
⑥レール	上揚力、水平力	曲げ、引張、せん断																																																							
⑦レール取付ボルト	上揚力、水平力	引張、せん断																																																							
⑧エンドプレート接合ボルト	上揚力、水平力	引張																																																							
⑨ベースポット支圧部	水平力	支圧																																																							
⑩上部接合ボルト	上揚力、水平力	引張、せん断																																																							
⑪下部接合ボルト	上揚力、水平力	引張、せん断																																																							
⑫ベースプレート	上揚力、水平力	曲げ、せん断																																																							
⑬ソールプレート(上板)	鉛直力(下向き)	支圧																																																							

赤字：設備、運用又は体制の相違（設計方針の相違）
 青字：記載箇所又は記載内容の相違（記載方針の相違）
 緑字：記載表現、設備名称の相違（実質的な相違なし）

大飯発電所3/4号炉	女川原子力発電所2号炉	泊発電所3号炉	相違理由
	<p>鉛直力(下向き) 支圧 ①すべり材</p> <p>鉛直力(下向き) 曲げ ②ピストン</p> <p>鉛直力(下向き) 支圧 ③圧縮ゴム</p> <p>鉛直力(下向き) 支圧 ④座金</p> <p>図7 可動支承の評価項目模式図 (1/5)</p>		

赤字：設備、運用又は体制の相違（設計方針の相違）
 青字：記載箇所又は記載内容の相違（記載方針の相違）
 緑字：記載表現、設備名称の相違（実質的な相違なし）

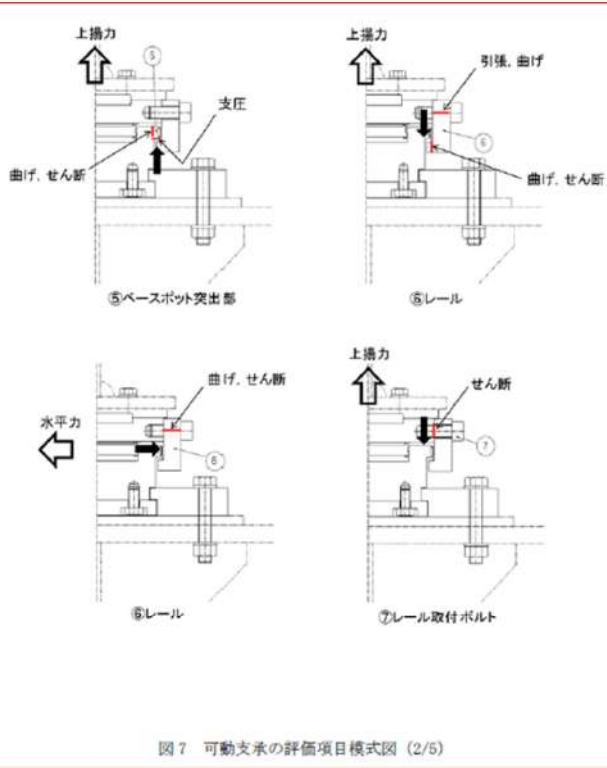
大飯発電所3/4号炉	女川原子力発電所2号炉	泊発電所3号炉	相違理由
	 <p style="text-align: center;">図7 可動支承の評価項目模式図 (2/5)</p>		

赤字：設備、運用又は体制の相違（設計方針の相違）
 青字：記載箇所又は記載内容の相違（記載方針の相違）
 緑字：記載表現、設備名称の相違（実質的な相違なし）

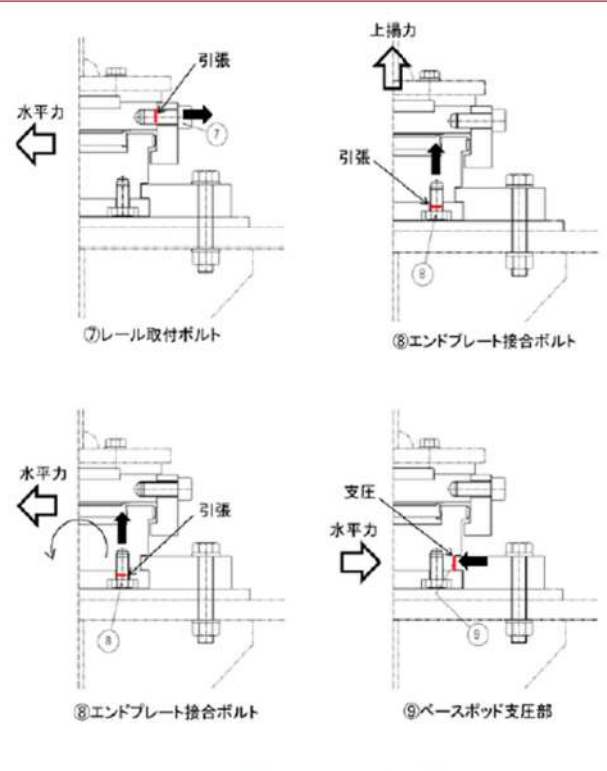
大飯発電所3/4号炉	女川原子力発電所2号炉	泊発電所3号炉	相違理由
	 <p data-bbox="898 935 1205 954">図7 可動支承の評価項目模式図（3/5）</p>		

赤字: 設備, 運用又は体制の相違 (設計方針の相違)
 青字: 記載箇所又は記載内容の相違 (記載方針の相違)
 緑字: 記載表現, 設備名称の相違 (実質的な相違なし)

大飯発電所3/4号炉	女川原子力発電所2号炉	泊発電所3号炉	相違理由
	<p>図7 可動支承の評価項目模式図 (4/5)</p>		

赤字：設備、運用又は体制の相違（設計方針の相違）
 青字：記載箇所又は記載内容の相違（記載方針の相違）
 緑字：記載表現、設備名称の相違（実質的な相違なし）

大飯発電所3/4号炉	女川原子力発電所2号炉	泊発電所3号炉	相違理由
	<p>図7 可動支承の評価項目模式図 (5/5)</p>		
	<p>9. ゴム支承と可動支承の評価対象部材の選定</p> <p>9.1 竜巻事象の経時変化を踏まえた荷重条件と評価項目</p> <p>竜巻時に考慮すべき状態は、図8に示すとおり「飛来物衝突時」及び飛来物衝突による影響を考慮した「飛来物衝突後」の状態であることから、これらの状態における荷重の組合せを考慮した上で、フレームゴム支承、可動支承に対して、波及的影響防止の観点から必要な評価対象部材の選定を実施する。</p>		

赤字：設備、運用又は体制の相違（設計方針の相違）
 青字：記載箇所又は記載内容の相違（記載方針の相違）
 緑字：記載表現、設備名称の相違（実質的な相違なし）

大飯発電所3/4号炉	女川原子力発電所2号炉	泊発電所3号炉	相違理由
	<div data-bbox="719 145 1317 571"> <p>図8 竜巻事象の経時変化を踏まえた荷重条件（イメージ）と評価項目</p> </div> <div data-bbox="712 576 1328 778"> <p>9.2 評価対象部材の選定プロセス</p> <p>竜巻防護ネットの構成部材である「フレームゴム支承」及び「可動支承」の評価対象部材の選定フローを図9に示す。</p> <p>「飛来物衝突時」及び「飛来物衝突後」における荷重状態において、「フレームゴム支承」又は「可動支承」の支持機能が喪失することにより、非常用海水ポンプ等に波及的影響を与える落下モードは以下のとおり。</p> <p>I. フレームゴム支承、可動支承の支持機能喪失による竜巻防護ネット自体の落下</p> <p>II. フレームゴム支承、可動支承の損傷による構成部材の落下（二次的影響）</p> <p>波及的影響を与える落下モードに対して、非常用海水ポンプ等への波及的影響を防止するための「フレームゴム支承」及び「可動支承」の構成部材を評価対象部材として選定する。</p> </div> <div data-bbox="712 1141 1328 1465"> <p>図9 評価対象部材の選定フロー</p> </div>		

赤字：設備、運用又は体制の相違（設計方針の相違）
 青字：記載箇所又は記載内容の相違（記載方針の相違）
 緑字：記載表現、設備名称の相違（実質的な相違なし）

大飯発電所3/4号炉	女川原子力発電所2号炉	泊発電所3号炉	相違理由
	<p>9.3 竜巻防護ネット落下防止のために支持機能が必要な部材の選定 (1) 南北方向の衝撃荷重を考慮した落下モード</p> <p>a. 落下モード検討における荷重条件 竜巻防護ネットの北側には防潮壁があるため、南北方向の衝撃荷重を考慮した落下モードは、南側からの飛来物の水平方向</p>  <p>図10 南北方向の衝撃荷重を考慮した落下モード検討における荷重条件</p> <p>b. 落下モードの検討 南北方向の衝撃荷重を考慮した落下モードは、フレームゴム支承2つが支持機能喪失した後に、南北方向から継続して風荷重が作用し、フレームが移動し落下する場合である。</p>  <p>図11 南北方向の衝撃荷重を考慮した落下モード</p> <p>c. 評価対象部材の選定 フレームゴム支承の支持機能喪失による竜巻防護ネットの落下モードを検討した結果、フレームの落下を防止するため支持機能を維持する必要がある部材は、「ゴム体」、「内部鋼板」、「取付ボルト」、「アンカーボルト」となる。よって、これらの部材を評価対象部材として選定する。</p>		

赤字：設備、運用又は体制の相違（設計方針の相違）
 青字：記載箇所又は記載内容の相違（記載方針の相違）
 緑字：記載表現、設備名称の相違（実質的な相違なし）

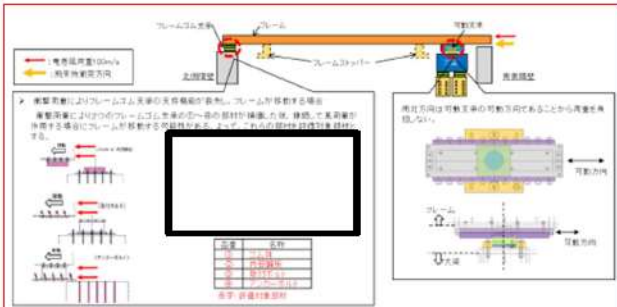
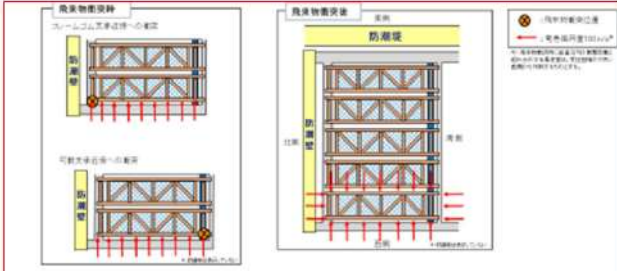
大飯発電所3/4号炉	女川原子力発電所2号炉	泊発電所3号炉	相違理由
	 <p>図12 南北方向の衝撃荷重に対する評価対象部材の選定</p> <p>(2) 鉛直方向の衝撃荷重を考慮した落下モード</p> <p>a. 落下モード検討における荷重条件</p> <p>鉛直方向の衝撃荷重を考慮した落下モードは、フレームゴム支承、可動支保それぞれの近傍に飛来物が鉛直衝突する場合を想定して検討する。</p>  <p>図13 鉛直方向の衝撃荷重を考慮した落下モード検討における荷重条件</p> <p>b-1. 落下モードの検討【フレームゴム支承に対する検討】</p> <p>鉛直方向の衝撃荷重を考慮した落下モードは、フレームゴム支承2つが支持機能喪失した後に、南北方向から継続して風荷重が作用し、フレームが移動し落下する場合である。（南北方向と同様）</p>		

赤字：設備、運用又は体制の相違（設計方針の相違）
 青字：記載箇所又は記載内容の相違（記載方針の相違）
 緑字：記載表現、設備名称の相違（実質的な相違なし）

大飯発電所3/4号炉	女川原子力発電所2号炉	泊発電所3号炉	相違理由
	<div data-bbox="712 140 1328 507"> <p>図14 鉛直方向の衝撃荷重を考慮した落下モード（フレームゴム支承の支持機能喪失）</p> </div> <div data-bbox="712 547 1328 778"> <p>b-2. 落下モードの検討【可動支承に対する検討】</p> <p>可動支承が支持機能喪失した後に風荷重が負荷される場合でも、健全なフレームゴム支承により竜巻防護ネットは支持されることから、フレームの落下は想定されない。</p> <p>ただし、飛来物衝突後の東西方向の風荷重により、フレームが東西方向にずれる可能性があるため、これを防止する必要がある。対応方針については、「9.3（4）飛来物衝突後の風荷重によるフレームのずれに対する対応方針」に示す。</p> </div> <div data-bbox="712 790 1328 1058"> <p>図15 鉛直方向の衝撃荷重を考慮した落下モード（可動支承の支持機能喪失）</p> </div> <div data-bbox="712 1102 1328 1473"> <p>c. 評価対象部材の選定</p> <p>フレームゴム支承の支持機能喪失による竜巻防護ネットの落下モードを検討した結果、フレームの落下を防止するため支持機能を維持する必要がある部材は、「ゴム体」、「内部鋼板」、「取付ボルト」、「アンカーボルト」となる。よって、これらの部材を評価対象部材として選定する。（南北方向の衝撃荷重を考慮した落下モードと同様）</p> <p>可動支承の支持機能喪失による竜巻防護ネットの落下モードを検討した結果、健全なフレームゴム支承によりフレームは支持されることから、フレームの落下は想定されないことを確認した。ただし、飛来物衝突後の東西方向の風荷重により、フレームが東西方向にずれる可能性があるため、これを防止するための対応方針を「9.3（4）飛来物衝突後の風荷重によるフレームのずれに対</p> </div>		

赤字：設備、運用又は体制の相違（設計方針の相違）
 青字：記載箇所又は記載内容の相違（記載方針の相違）
 緑字：記載表現、設備名称の相違（実質的な相違なし）

大飯発電所3/4号炉	女川原子力発電所2号炉	泊発電所3号炉	相違理由
	<p>する対応方針」に示す。</p> <p>(3) 東西方向の衝撃荷重を考慮した落下モード</p> <p>a. 落下モード検討における荷重条件</p> <p>竜巻防護ネットの東側には防潮堤があるため、東西方向の衝撃荷重を考慮した落下モードは、西側からの飛来物の水平方向衝突を代表して検討する。</p> <p>落下モードの検討は、フレームゴム支承、可動支承それぞれの近傍に飛来物が水平衝突する場合を想定して検討する。</p>  <p>図16 東西方向の衝撃荷重を考慮した落下モード検討における荷重条件</p> <p>b-1. 落下モードの検討【フレームゴム支承に対する検討】</p> <p>東西方向の衝撃荷重を考慮した落下モードは、フレームゴム支承2つが支持機能喪失した後に、南北方向から継続して風荷重が作用し、フレームが移動し落下する場合である。（南北・鉛直方向と同様）</p>  <p>図17 東西方向の衝撃荷重を考慮した落下モード（フレームゴム支承の支持機能喪失）</p> <p>b-2. 落下モードの検討【可動支承に対する検討】</p> <p>可動支承が支持機能喪失した後に風荷重が負荷される場合でも、健全なフレームゴム支承により竜巻防護ネットは支持されることから、フレームの落下が発生する可能性はない。</p> <p>ただし、飛来物衝突後の東西方向の風荷重により、フレームが東西方向にずれる可能性があるため、これを防止する必要がある。対応方針については、「9.3 (4) 飛来物衝突後の風荷重によるフレームのずれに対する対応方針」に示す。</p>		

赤字：設備、運用又は体制の相違（設計方針の相違）
 青字：記載箇所又は記載内容の相違（記載方針の相違）
 緑字：記載表現、設備名称の相違（実質的な相違なし）

大飯発電所3/4号炉	女川原子力発電所2号炉	泊発電所3号炉	相違理由
	 <p>図18 鉛直方向の衝撃荷重を考慮した落下モード（可動支承の支持機能喪失）</p> <p>c. 評価対象部材の選定</p> <p>フレームゴム支承の支持機能喪失による竜巻防護ネットの落下モードを検討した結果、フレームの落下を防止するため支持機能を維持する必要がある部材は、「ゴム体」、「内部鋼板」、「取付ボルト」、「アンカーボルト」となる。よって、これらの部材を評価対象部材として選定する。（南北方向・鉛直方向の衝撃荷重を考慮した落下モードと同様）</p> <p>可動支承の支持機能喪失による竜巻防護ネットの落下モードを検討した結果、健全なフレームゴム支承によりフレームは支持されることから、フレームの落下は想定されないことを確認した。ただし、飛来物衝突後の東西方向の風荷重により、フレームが東西方向にずれる可能性があるため、これを防止するための対応方針を「9.3（4）飛来物衝突後の風荷重によるフレームのずれに対する対応方針」に示す。</p> <p>(4) 飛来物衝突後の風荷重によるフレームのずれに対する対応方針</p> <p>各方向からの衝撃荷重による落下モードを検討において、竜巻防護ネットの落下には至らないが、可動支承2つが衝撃荷重により支持機能を喪失した場合、飛来物衝突後の東西方向の風荷重により、フレームが東西方向にずれるモードを確認した。フレームがずれることによって、隣のフレームへの接触や隙間が発生することから、これを防止するため、可動支承に対して、以下の方針を設定する。</p> <ul style="list-style-type: none"> ➤ 可動支承は構成する部材のうち、主な支持機能を担う部材（図19参照）について評価対象部材として選定し、フレームの東西方向のずれが生じない設計とする。 ➤ 評価対象部材のうち、可動支承の上部接合ボルトや下部接合ボルト、レール等については、設置許可段階における構造成立性の見直しにおいて可動支承近傍へ飛来物が衝突した場合、許容限界を超える結果となっているが、詳細設計段階では、可動支承のサイズアップやボルトの仕様変更等の対応を行うことで、許容限界を満足させる方針とする。（設置許可段階における評価状況は別紙4参照） 		

赤字：設備、運用又は体制の相違（設計方針の相違）
 青字：記載箇所又は記載内容の相違（記載方針の相違）
 緑字：記載表現、設備名称の相違（実質的な相違なし）

大飯発電所3/4号炉	女川原子力発電所2号炉	泊発電所3号炉	相違理由																										
	<div data-bbox="817 204 1261 531" style="border: 1px solid black; padding: 5px;"> <p>飛来物衝突後</p> <p>(フレームのずれが発生するモード)(西側からの風荷重を代表で検討)</p>  <p>西側からの竜巻荷重を受けた場合、隣のフレームおよび構造物があるため、竜巻防護ネットの落下は想定されない。 ただし、飛来物衝突後の東西方向の風荷重により、フレームが東西方向にずれ、隣のフレームへの接触や相関が発生する。</p> </div> <div data-bbox="719 564 797 587" style="margin-top: 10px;"> <p>可動支承</p> </div> <div data-bbox="719 612 1059 863" style="margin-top: 10px;">  </div> <div data-bbox="1070 555 1296 798" style="margin-top: 10px;"> <table border="1"> <thead> <tr> <th>品番</th> <th>名称</th> </tr> </thead> <tbody> <tr><td>①</td><td>ソールプレート</td></tr> <tr><td>②</td><td>すべり材^{※1}</td></tr> <tr><td>③</td><td>圧縮ゴム^{※1}</td></tr> <tr><td>④</td><td>ピストン^{※1}</td></tr> <tr><td>⑤</td><td>座金^{※2}</td></tr> <tr><td>⑥</td><td>ベースポット</td></tr> <tr><td>⑦</td><td>レール</td></tr> <tr><td>⑧</td><td>レール取付ボルト</td></tr> <tr><td>⑨</td><td>エンドプレート接合ボルト</td></tr> <tr><td>⑩</td><td>上部接合ボルト</td></tr> <tr><td>⑪</td><td>下部接合ボルト</td></tr> <tr><td>⑫</td><td>ベースプレート</td></tr> </tbody> </table> </div> <div data-bbox="1081 799 1301 922" style="margin-top: 10px;"> <p>赤字: 評価対象部材 ※1: すべり材、圧縮ゴム、ピストンは可動機能にのみ必要な部材であることから、損傷した場合でも支持機能への影響はない。 ※2: 座金については防錆の観点から必要な部材であることから、損傷した場合でも、支持機能への影響はない。</p> </div> <div data-bbox="707 954 999 976" style="margin-top: 10px;"> <p>図 19 可動支承の評価対象部材</p> </div> <div data-bbox="719 1011 904 1034" style="margin-top: 10px;"> <p>(5) 選定結果まとめ</p> </div> <div data-bbox="745 1040 1328 1179" style="margin-top: 10px;"> <p>フレームゴム支承、可動支承の支持機能喪失による竜巻防護ネットの落下モードとして、「(1) 南北方向の衝撃荷重を考慮した落下モード」、「(2) 鉛直方向の衝撃荷重を考慮した落下モード」、「(3) 東西方向の衝撃荷重を考慮した落下モード」を検討した。</p> </div> <div data-bbox="745 1185 1328 1267" style="margin-top: 10px;"> <p>(1)～(3)の落下モードにおいて、フレームの落下が想定されるのは、フレームゴム支承2つが支持機能喪失した後に、南北方向から継続して風荷重が負荷される場合である。</p> </div> <div data-bbox="745 1273 1328 1385" style="margin-top: 10px;"> <p>フレームの落下を防止するため、支持機能を維持する必要があるフレームゴム支承の部材は、「ゴム体」、「内部鋼板」、「取付ボルト」、「アンカーボルト」となることから、これらの部材を支持機能維持のための評価対象部材として選定する。</p> </div> <div data-bbox="745 1391 1328 1473" style="margin-top: 10px;"> <p>可動支承の支持機能喪失による竜巻防護ネットの落下モードを検討した結果、健全なフレームゴム支承によりフレームは支持されることから、フレームの落下は想定されないことを確認した。た</p> </div>	品番	名称	①	ソールプレート	②	すべり材 ^{※1}	③	圧縮ゴム ^{※1}	④	ピストン ^{※1}	⑤	座金 ^{※2}	⑥	ベースポット	⑦	レール	⑧	レール取付ボルト	⑨	エンドプレート接合ボルト	⑩	上部接合ボルト	⑪	下部接合ボルト	⑫	ベースプレート		
品番	名称																												
①	ソールプレート																												
②	すべり材 ^{※1}																												
③	圧縮ゴム ^{※1}																												
④	ピストン ^{※1}																												
⑤	座金 ^{※2}																												
⑥	ベースポット																												
⑦	レール																												
⑧	レール取付ボルト																												
⑨	エンドプレート接合ボルト																												
⑩	上部接合ボルト																												
⑪	下部接合ボルト																												
⑫	ベースプレート																												

赤字：設備、運用又は体制の相違（設計方針の相違）
 青字：記載箇所又は記載内容の相違（記載方針の相違）
 緑字：記載表現、設備名称の相違（実質的な相違なし）

大飯発電所3/4号炉	女川原子力発電所2号炉	泊発電所3号炉	相違理由
	<p>だし、飛来物衝突後の東西方向の風荷重により、フレームが東西方向にずれる可能性があるため、これを防止するため、主な支持機能に係る部材として、「ソールプレート」、「ベースポット」、「レール」、「レール取付ボルト」、「エンドプレート接合ボルト」、「上部接合ボルト」、「下部接合ボルト」、「ベースプレート」を評価対象部材として選定する。</p> <p>9.4 波及的影響防止（二次的影響）のための部材の選定 竜巻による荷重条件を踏まえた、フレームゴム支承、可動支承の損傷による構成部材の落下モード（二次的影響）を検討し、部材の落下による波及的影響を防止するために必要な構成部材を評価対象部材として選定する。</p> <p>「9.3 竜巻防護ネット落下防止のために支持機能が必要な部材の選定」において選定した部材は、既に評価対象部材として選定していることから、ここでは、支持機能評価の対象部材として選定していない可動支承の部材に対して評価を実施する。また、フレームゴム支承は、2つのうち1つ以上が構造強度上の評価方針を満足することを確認することとしていることから、仮にフレームゴム支承の1つが許容限界を上回った場合における波及的影響について評価を実施する。</p> <p>(1) 可動支承の部材のうち支持機能評価の対象部材として選定していない部材に対する二次的影響評価について 可動支承のうち「すべり材」、「圧縮ゴム」、「ピストン」、「座金」については、支持機能評価の対象部材として選定していないため、波及的影響防止の観点から評価を実施する。</p> <p>a. すべり材、圧縮ゴム、ピストン 「すべり材」、「圧縮ゴム」、「ピストン」については、ソールプレートとベースポットの内部にある構造物である。これらの部材は、支持機能評価対象部材であるソールプレート、ベースポットが許容値を満足することで、落下は発生しないため、波及的影響（二次的影響）に対して影響がないことを確認した。</p> <p>b. 座金 「座金」については、ベースポットとベースプレートの間にはボルトによって挟み込まれているため、仮に損傷しても落下に至る可能性は低い。仮に落下したとしても、重量は0.1 kg程度であり、他の設計飛来物である砂利（0.2 kg）に包絡されるため、波及的影響（二次的影響）に対して影響がないことを確認した。</p> <p>以上より、可動支承の部材のうち、「すべり材」、「圧縮ゴム」、「ピストン」、「座金」については二次的影響がないことを確認した。これらの部材が竜巻による荷重により損傷</p>		

赤字：設備、運用又は体制の相違（設計方針の相違）
 青字：記載箇所又は記載内容の相違（記載方針の相違）
 緑字：記載表現、設備名称の相違（実質的な相違なし）

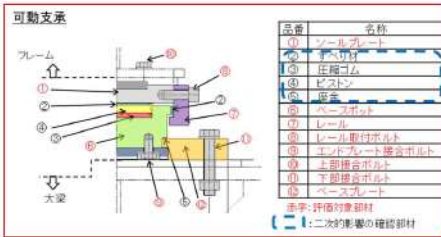
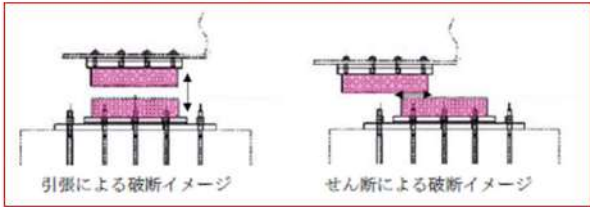
大飯発電所3/4号炉	女川原子力発電所2号炉	泊発電所3号炉	相違理由
	<p>した場合には速やかに補修を実施することとする。</p>  <p>図20 可動支承の二次的影響確認部材</p> <p>(2) フレームゴム支承に対する二次的影響評価について フレームゴム支承の評価対象部材である「ゴム体」「内部鋼板」「取付ボルト」「アンカーボルト」が許容限界を超えた場合の波及的影響（二次的影響）について評価を実施する。</p> <p>a. ゴム体 ゴム体における損傷モードは「引張による破断」、「せん断ひずみによる破断」、「圧縮による座屈」となる。このうち、「引張による破断」又は「せん断ひずみによる破断」が発生した場合に、ゴム体が上下に破断することが想定されるが、ゴム体上部は取付ボルトによりフレームに取り付けられ、ゴム体下部はアンカーボルトにより隔壁に固定されることとなり、ゴム体の落下は想定されない。 また、圧縮により座屈した場合においても、ゴム体が上下に破断することは考え難いため、落下は想定されない。 以上より、ゴム体が許容限界を超えた場合でも、波及的影響（二次的影響）を及ぼさないことを確認した。</p>  <p>b. 内部鋼板 内部鋼板における損傷モードは「引張による破断」となる。 内部鋼板が引張により破断した場合でも内部鋼板はゴム体に接着されていることから、内部鋼板の落下は想定されない。よって、内部鋼板が許容限界を超えた場合でも、波及的影響（二次的影響）を及ぼさないことを確認</p>		

赤字：設備、運用又は体制の相違（設計方針の相違）
 青字：記載箇所又は記載内容の相違（記載方針の相違）
 緑字：記載表現、設備名称の相違（実質的な相違なし）

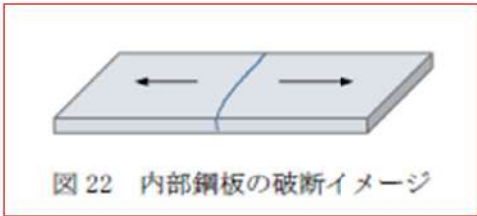
大飯発電所3/4号炉	女川原子力発電所2号炉	泊発電所3号炉	相違理由																																								
	<p>した。</p>  <p>図22 内部鋼板の破断イメージ</p> <p>c. 取付ボルト、アンカーボルト</p> <p>取付ボルト、アンカーボルトの損傷モードは「引張又はせん断によるボルトの破断」となる。ボルトが破断した場合、ボルト頂部の落下が想定されるが、フレームゴム支承の評価対象部材において、引張又はせん断力に対する許容荷重を比較すると、ゴム体が最も小さいため、取付ボルト又はアンカーボルトが損傷する前にゴム体が破断することが想定される。ゴム体が破断することにより、エネルギーの伝達経路が途切れるため、取付ボルト、アンカーボルトに対し、許容限界を超える荷重が負荷され、破断することは想定し難い。</p> <p>以上より、取付ボルト、アンカーボルトは波及的影響（二次的影響）を及ぼさないと判断する。</p> <table border="1" data-bbox="712 879 1328 1345"> <caption>表10 フレームゴム支承のゴム体、取付ボルト、アンカーボルトの許容荷重比較</caption> <thead> <tr> <th colspan="4">(a) せん断</th> </tr> <tr> <th>仕様</th> <th>許容荷重(せん断)</th> <th colspan="2">(許容値)</th> </tr> </thead> <tbody> <tr> <td>ゴム体 (せん断ひずり)</td> <td>せん断剛性 2.689 kN/mm 総ゴム厚 135mm □550 mm</td> <td>908kN</td> <td>250%</td> </tr> <tr> <td>取付ボルト (全数)</td> <td>M27×16 本 強度区分 8.8</td> <td>2959kN</td> <td>323MPa</td> </tr> <tr> <td>アンカーボルト (全数)</td> <td>D25(ねじ部 M24)×16 本 (SD390)</td> <td>1635kN</td> <td>226MPa</td> </tr> </tbody> <thead> <tr> <th colspan="4">(b) 引張</th> </tr> <tr> <th>仕様</th> <th>許容荷重(引張)</th> <th colspan="2">(許容値)</th> </tr> </thead> <tbody> <tr> <td>ゴム体</td> <td>総ゴム厚 135mm □550 mm</td> <td>605kN</td> <td>2.0MPa</td> </tr> <tr> <td>取付ボルト (全数)</td> <td>M27×16 本 強度区分 8.8</td> <td>3848kN</td> <td>420MPa</td> </tr> <tr> <td>アンカーボルト (全数)</td> <td>D25(ねじ部 M24)×16 本 (SD390)</td> <td>2128kN</td> <td>294MPa</td> </tr> </tbody> </table> <p>9.5 評価対象部材の選定結果</p> <p>フレームゴム支承、可動支承に対して、支持機能・二次的影響の観点で落下モードを検討し、非常用海水ポンプ等への波及的影響</p>	(a) せん断				仕様	許容荷重(せん断)	(許容値)		ゴム体 (せん断ひずり)	せん断剛性 2.689 kN/mm 総ゴム厚 135mm □550 mm	908kN	250%	取付ボルト (全数)	M27×16 本 強度区分 8.8	2959kN	323MPa	アンカーボルト (全数)	D25(ねじ部 M24)×16 本 (SD390)	1635kN	226MPa	(b) 引張				仕様	許容荷重(引張)	(許容値)		ゴム体	総ゴム厚 135mm □550 mm	605kN	2.0MPa	取付ボルト (全数)	M27×16 本 強度区分 8.8	3848kN	420MPa	アンカーボルト (全数)	D25(ねじ部 M24)×16 本 (SD390)	2128kN	294MPa		
(a) せん断																																											
仕様	許容荷重(せん断)	(許容値)																																									
ゴム体 (せん断ひずり)	せん断剛性 2.689 kN/mm 総ゴム厚 135mm □550 mm	908kN	250%																																								
取付ボルト (全数)	M27×16 本 強度区分 8.8	2959kN	323MPa																																								
アンカーボルト (全数)	D25(ねじ部 M24)×16 本 (SD390)	1635kN	226MPa																																								
(b) 引張																																											
仕様	許容荷重(引張)	(許容値)																																									
ゴム体	総ゴム厚 135mm □550 mm	605kN	2.0MPa																																								
取付ボルト (全数)	M27×16 本 強度区分 8.8	3848kN	420MPa																																								
アンカーボルト (全数)	D25(ねじ部 M24)×16 本 (SD390)	2128kN	294MPa																																								

赤字：設備、運用又は体制の相違（設計方針の相違）
 青字：記載箇所又は記載内容の相違（記載方針の相違）
 緑字：記載表現、設備名称の相違（実質的な相違なし）

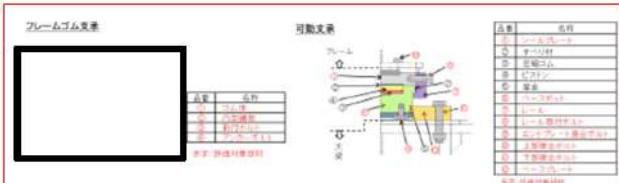
大飯発電所3/4号炉	女川原子力発電所2号炉	泊発電所3号炉	相違理由																				
	<p>を防止するために必要な構成部材を検討した結果、以下の部材を評価対象部材として選定した。 評価対象部材として選定した部材について、「飛来物衝突時」及び「飛来物衝突後」の波及的影響の確認として、支持機能評価及び二次的影響評価を実施する。</p>  <p>図23 フレームゴム支承、可動支承の評価対象部材</p> <table border="1" data-bbox="712 590 1299 813"> <caption>表11 フレームゴム支承と可動支承に対する評価項目</caption> <thead> <tr> <th colspan="3" rowspan="2">評価項目</th> <th rowspan="2">通常状態</th> <th colspan="2">竜巻時</th> <th rowspan="2">竜巻通過後*</th> </tr> <tr> <th>飛来物衝突時</th> <th>飛来物衝突後</th> </tr> </thead> <tbody> <tr> <td rowspan="2">支持機能評価</td> <td>波及的影響</td> <td></td> <td>○</td> <td>○</td> <td></td> </tr> <tr> <td>二次的影響評価</td> <td></td> <td>○</td> <td>○</td> <td></td> </tr> </tbody> </table> <p>※：竜巻通過後は竜巻時の評価に包絡される ○：実施項目</p> <p>9.6 フレームゴム支承、可動支承の評価対象部材以外の部材の扱いについて</p> <p>フレームゴム支承、可動支承の評価対象部材以外の部材については、各部材の許容応力から算出される許容荷重を比較し、評価対象部材と同様の荷重モードが負荷される部材については、許容荷重が小さい評価対象部材を代表として強度評価を実施することとする（各部材には、衝突解析等から算出された荷重が同一に負荷される）。以下に各部品に対する代表性を整理する。</p> <p>(1) フレームゴム支承、可動支承の評価部材の代表性について フレームゴム支承、可動支承の部品毎に荷重モード、評価対象部材の代表性を整理した結果を表12及び表13に整理する。</p>	評価項目			通常状態	竜巻時		竜巻通過後*	飛来物衝突時	飛来物衝突後	支持機能評価	波及的影響		○	○		二次的影響評価		○	○			
評価項目						通常状態	竜巻時		竜巻通過後*														
			飛来物衝突時	飛来物衝突後																			
支持機能評価	波及的影響		○	○																			
	二次的影響評価		○	○																			

赤字：設備、運用又は体制の相違（設計方針の相違）
 青字：記載箇所又は記載内容の相違（記載方針の相違）
 緑字：記載表現、設備名称の相違（実質的な相違なし）

第6条 外部からの衝撃による損傷の防止（竜巻：別添1 添付資料3.13）

大飯発電所3/4号炉	女川原子力発電所2号炉	泊発電所3号炉	相違理由																																																							
	<p style="text-align: center;">表 12 フレームゴム支承の強度評価の代表性について</p> <table border="1" data-bbox="703 148 1303 502"> <thead> <tr> <th>品番</th> <th>名称</th> <th>評価対象部材</th> <th>主な荷重モード</th> <th>強度評価の代表性</th> </tr> </thead> <tbody> <tr> <td>①</td> <td>ゴム体</td> <td>○</td> <td>せん断 引張 圧縮</td> <td>—</td> </tr> <tr> <td>②</td> <td>内部鋼板</td> <td>○</td> <td>引張</td> <td>—</td> </tr> <tr> <td>③</td> <td>取付ボルト</td> <td>○</td> <td>引張 せん断</td> <td>—</td> </tr> <tr> <td>④</td> <td>アンカーボルト</td> <td>○</td> <td>引張 せん断</td> <td>—</td> </tr> <tr> <td>⑤</td> <td>上蓋</td> <td>—</td> <td>せん断*</td> <td>強度評価はゴム体で代表</td> </tr> <tr> <td>⑥</td> <td>下蓋</td> <td>—</td> <td>せん断*</td> <td>強度評価はゴム体で代表</td> </tr> <tr> <td>⑦</td> <td>締結ボルト</td> <td>—</td> <td>引張 せん断</td> <td>強度評価はゴム体で代表</td> </tr> <tr> <td>⑧</td> <td>ベースプレート</td> <td>—</td> <td>曲げ* せん断</td> <td>強度評価はアンカーボルトで代表</td> </tr> <tr> <td>⑨</td> <td>せん断キー</td> <td>—</td> <td>せん断 支圧</td> <td>フレームとゴム支承の位置決め部品であり、機能としては取付ボルトに代替されるため、取付ボルトを代表とする</td> </tr> <tr> <td>⑩</td> <td>上下鋼板</td> <td>—</td> <td>せん断*</td> <td>強度評価はゴム体で代表</td> </tr> </tbody> </table> <p><small>※ 厚さ40mmの鋼板であることから、引張・圧縮は十分な裕度があることを評価したため、主要な荷重モードとしてせん断又は曲げを考慮した。</small></p> <div style="text-align: center;">  <p>図 24 フレームゴム支承構成部材詳細</p> </div>	品番	名称	評価対象部材	主な荷重モード	強度評価の代表性	①	ゴム体	○	せん断 引張 圧縮	—	②	内部鋼板	○	引張	—	③	取付ボルト	○	引張 せん断	—	④	アンカーボルト	○	引張 せん断	—	⑤	上蓋	—	せん断*	強度評価はゴム体で代表	⑥	下蓋	—	せん断*	強度評価はゴム体で代表	⑦	締結ボルト	—	引張 せん断	強度評価はゴム体で代表	⑧	ベースプレート	—	曲げ* せん断	強度評価はアンカーボルトで代表	⑨	せん断キー	—	せん断 支圧	フレームとゴム支承の位置決め部品であり、機能としては取付ボルトに代替されるため、取付ボルトを代表とする	⑩	上下鋼板	—	せん断*	強度評価はゴム体で代表		
品番	名称	評価対象部材	主な荷重モード	強度評価の代表性																																																						
①	ゴム体	○	せん断 引張 圧縮	—																																																						
②	内部鋼板	○	引張	—																																																						
③	取付ボルト	○	引張 せん断	—																																																						
④	アンカーボルト	○	引張 せん断	—																																																						
⑤	上蓋	—	せん断*	強度評価はゴム体で代表																																																						
⑥	下蓋	—	せん断*	強度評価はゴム体で代表																																																						
⑦	締結ボルト	—	引張 せん断	強度評価はゴム体で代表																																																						
⑧	ベースプレート	—	曲げ* せん断	強度評価はアンカーボルトで代表																																																						
⑨	せん断キー	—	せん断 支圧	フレームとゴム支承の位置決め部品であり、機能としては取付ボルトに代替されるため、取付ボルトを代表とする																																																						
⑩	上下鋼板	—	せん断*	強度評価はゴム体で代表																																																						

赤字：設備、運用又は体制の相違（設計方針の相違）
 青字：記載箇所又は記載内容の相違（記載方針の相違）
 緑字：記載表現、設備名称の相違（実質的な相違なし）

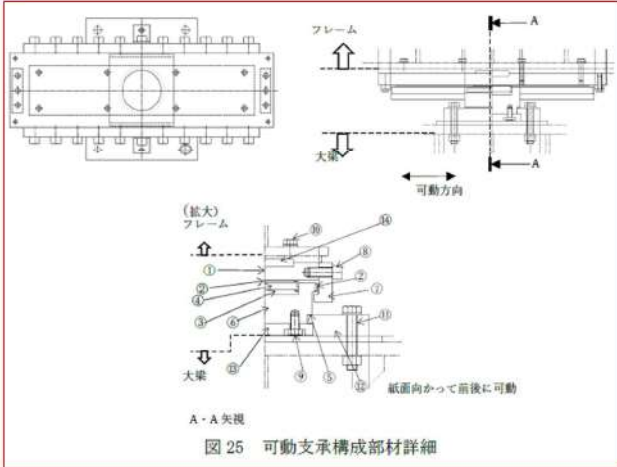
大飯発電所3/4号炉	女川原子力発電所2号炉	泊発電所3号炉	相違理由																																																																							
	<p>表13 可動支承の強度評価の代表性について</p> <table border="1"> <thead> <tr> <th>品番</th> <th>名称</th> <th>評価対象部材</th> <th>主な荷重モード</th> <th>強度評価の代表性</th> </tr> </thead> <tbody> <tr> <td>①</td> <td>ソールプレート</td> <td>○</td> <td>支圧</td> <td rowspan="4">支持機能に影響ないことを確認した部材</td> </tr> <tr> <td>②</td> <td>すべり材</td> <td>—</td> <td>支圧</td> </tr> <tr> <td>③</td> <td>圧縮ゴム</td> <td>—</td> <td>支圧</td> </tr> <tr> <td>④</td> <td>ピストン</td> <td>—</td> <td>曲げ</td> </tr> <tr> <td>⑤</td> <td>座金</td> <td>—</td> <td>支圧</td> <td rowspan="2">—</td> </tr> <tr> <td>⑥</td> <td>ベースポット (突出部)</td> <td>○</td> <td>曲げ せん断 支圧</td> </tr> <tr> <td>⑦</td> <td>レール</td> <td>○</td> <td>曲げ 引張 せん断</td> <td>—</td> </tr> <tr> <td>⑧</td> <td>レール取付ボルト</td> <td>○</td> <td>引張 せん断</td> <td>—</td> </tr> <tr> <td>⑨</td> <td>エンドプレート接合ボルト</td> <td>○</td> <td>引張</td> <td>—</td> </tr> <tr> <td>⑩</td> <td>上部接合ボルト</td> <td>○</td> <td>引張 せん断</td> <td>—</td> </tr> <tr> <td>⑪</td> <td>下部接合ボルト</td> <td>○</td> <td>引張 せん断</td> <td>—</td> </tr> <tr> <td>⑫</td> <td>ベースプレート</td> <td>○</td> <td>曲げ せん断</td> <td>—</td> </tr> <tr> <td>⑬</td> <td>エンドプレート</td> <td>—</td> <td>曲げ*</td> <td>強度評価はエンドプレート接合ボルトで代表</td> </tr> <tr> <td>⑭</td> <td>せん断キー</td> <td>—</td> <td>せん断 支圧</td> <td>フレームと可動支承位置決め部品であり、機能としては上部接合ボルトに代替されるため、上部接合ボルトを代表とする</td> </tr> </tbody> </table> <p>* 厚さ36mmの鋼板であることから、引張・圧縮は十分な裕度があることを評価したため、主要な荷重モードとして曲げを考慮した。</p>  <p>図25 可動支承構成部材詳細</p> <p>(2) フレームゴム支承に対する評価部材の代表性検討 各部材の許容応力から算出される許容荷重を比較し、同様の荷重モードが負荷される部材については、許容荷重が小さい部材を代表として強度評価を実施することとする。</p> <p>a. 上杓・下杓・締結ボルト・上下鋼板 上杓・下杓・締結ボルト・上下鋼板に作用する主な荷重としてせん断があるが、許容荷重はゴム体が最も小さいことから、これらの部材の強度評価はゴム体で代表する。また、締結ボルト</p>	品番	名称	評価対象部材	主な荷重モード	強度評価の代表性	①	ソールプレート	○	支圧	支持機能に影響ないことを確認した部材	②	すべり材	—	支圧	③	圧縮ゴム	—	支圧	④	ピストン	—	曲げ	⑤	座金	—	支圧	—	⑥	ベースポット (突出部)	○	曲げ せん断 支圧	⑦	レール	○	曲げ 引張 せん断	—	⑧	レール取付ボルト	○	引張 せん断	—	⑨	エンドプレート接合ボルト	○	引張	—	⑩	上部接合ボルト	○	引張 せん断	—	⑪	下部接合ボルト	○	引張 せん断	—	⑫	ベースプレート	○	曲げ せん断	—	⑬	エンドプレート	—	曲げ*	強度評価はエンドプレート接合ボルトで代表	⑭	せん断キー	—	せん断 支圧	フレームと可動支承位置決め部品であり、機能としては上部接合ボルトに代替されるため、上部接合ボルトを代表とする		
品番	名称	評価対象部材	主な荷重モード	強度評価の代表性																																																																						
①	ソールプレート	○	支圧	支持機能に影響ないことを確認した部材																																																																						
②	すべり材	—	支圧																																																																							
③	圧縮ゴム	—	支圧																																																																							
④	ピストン	—	曲げ																																																																							
⑤	座金	—	支圧	—																																																																						
⑥	ベースポット (突出部)	○	曲げ せん断 支圧																																																																							
⑦	レール	○	曲げ 引張 せん断	—																																																																						
⑧	レール取付ボルト	○	引張 せん断	—																																																																						
⑨	エンドプレート接合ボルト	○	引張	—																																																																						
⑩	上部接合ボルト	○	引張 せん断	—																																																																						
⑪	下部接合ボルト	○	引張 せん断	—																																																																						
⑫	ベースプレート	○	曲げ せん断	—																																																																						
⑬	エンドプレート	—	曲げ*	強度評価はエンドプレート接合ボルトで代表																																																																						
⑭	せん断キー	—	せん断 支圧	フレームと可動支承位置決め部品であり、機能としては上部接合ボルトに代替されるため、上部接合ボルトを代表とする																																																																						

赤字：設備、運用又は体制の相違（設計方針の相違）
 青字：記載箇所又は記載内容の相違（記載方針の相違）
 緑字：記載表現、設備名称の相違（実質的な相違なし）

大飯発電所3/4号炉	女川原子力発電所2号炉	泊発電所3号炉	相違理由																																				
	<p>には引張も作用するが、これについても許容荷重はゴム体のほうが小さいため、ゴム体を代表として強度評価を実施する。</p> <p>表 14 上香・下香・締結ボルト・上下鋼板及びゴム体の許容荷重（せん断）比較</p> <table border="1"> <thead> <tr> <th>仕様</th> <th>許容荷重（せん断）</th> <th>許容値</th> </tr> </thead> <tbody> <tr> <td>①ゴム体 (せん断ひずみ) せん断剛性 2.689 kN/mm 総ゴム厚 135mm □550 mm</td> <td>908kN</td> <td>250%</td> </tr> <tr> <td>⑤上香 t40×□620 mm SM490A</td> <td>1521kN</td> <td>198MPa</td> </tr> <tr> <td>⑥下香 t40×□670 mm SM490A</td> <td>1917kN</td> <td>198MPa</td> </tr> <tr> <td>⑦締結ボルト M22×16 本 強度区分 10.9</td> <td>2457kN</td> <td>404MPa</td> </tr> <tr> <td>⑩上下鋼板 t40×□550 mm SM490A</td> <td>966kN</td> <td>198MPa</td> </tr> </tbody> </table> <p>表 15 締結ボルト及びゴム体の許容荷重（引張）比較</p> <table border="1"> <thead> <tr> <th>仕様</th> <th>許容荷重（引張）</th> <th>許容値</th> </tr> </thead> <tbody> <tr> <td>①ゴム体 総ゴム厚 135mm □550 mm</td> <td>605kN</td> <td>2.0MPa</td> </tr> <tr> <td>⑦締結ボルト M22×16 本 強度区分 10.9</td> <td>3193kN</td> <td>525MPa</td> </tr> </tbody> </table> <p>b. ベースプレート</p> <p>ゴム支承を隔壁に固定するベースプレートについて、アンカーボルトが引張荷重を受ける場合はアンカーボルトと支承との溶接部間で曲げ荷重を受け、アンカーボルトがせん断荷重を受ける場合はせん断荷重を受ける。</p> <p>ここで、各ケースの許容荷重を整理した下表より、いずれのケースでも許容荷重はアンカーボルトの方が小さいため、ベースプレートの強度評価はアンカーボルトで代表する。</p> <p>表 16 ベースプレートとアンカーボルトの許容荷重比較</p> <table border="1"> <thead> <tr> <th>仕様</th> <th>許容荷重</th> <th>(許容値)</th> </tr> </thead> <tbody> <tr> <td>④アンカーボルト D25 (ねじ部 M24) × 16 本 SD390</td> <td>665kN (引張) *</td> <td>294MPa</td> </tr> <tr> <td>⑧ベースプレート t40×1160×1050 SM490A</td> <td>763kN (曲げ)</td> <td>395MPa</td> </tr> </tbody> </table> <p>※ベースプレートとの許容荷重比較のため、下図に示すボルト5本に対する許容荷重を算出</p> <div style="border: 2px solid black; height: 100px; width: 100%;"></div>	仕様	許容荷重（せん断）	許容値	①ゴム体 (せん断ひずみ) せん断剛性 2.689 kN/mm 総ゴム厚 135mm □550 mm	908kN	250%	⑤上香 t40×□620 mm SM490A	1521kN	198MPa	⑥下香 t40×□670 mm SM490A	1917kN	198MPa	⑦締結ボルト M22×16 本 強度区分 10.9	2457kN	404MPa	⑩上下鋼板 t40×□550 mm SM490A	966kN	198MPa	仕様	許容荷重（引張）	許容値	①ゴム体 総ゴム厚 135mm □550 mm	605kN	2.0MPa	⑦締結ボルト M22×16 本 強度区分 10.9	3193kN	525MPa	仕様	許容荷重	(許容値)	④アンカーボルト D25 (ねじ部 M24) × 16 本 SD390	665kN (引張) *	294MPa	⑧ベースプレート t40×1160×1050 SM490A	763kN (曲げ)	395MPa		
仕様	許容荷重（せん断）	許容値																																					
①ゴム体 (せん断ひずみ) せん断剛性 2.689 kN/mm 総ゴム厚 135mm □550 mm	908kN	250%																																					
⑤上香 t40×□620 mm SM490A	1521kN	198MPa																																					
⑥下香 t40×□670 mm SM490A	1917kN	198MPa																																					
⑦締結ボルト M22×16 本 強度区分 10.9	2457kN	404MPa																																					
⑩上下鋼板 t40×□550 mm SM490A	966kN	198MPa																																					
仕様	許容荷重（引張）	許容値																																					
①ゴム体 総ゴム厚 135mm □550 mm	605kN	2.0MPa																																					
⑦締結ボルト M22×16 本 強度区分 10.9	3193kN	525MPa																																					
仕様	許容荷重	(許容値)																																					
④アンカーボルト D25 (ねじ部 M24) × 16 本 SD390	665kN (引張) *	294MPa																																					
⑧ベースプレート t40×1160×1050 SM490A	763kN (曲げ)	395MPa																																					

赤字：設備、運用又は体制の相違（設計方針の相違）
 青字：記載箇所又は記載内容の相違（記載方針の相違）
 緑字：記載表現、設備名称の相違（実質的な相違なし）

大飯発電所3/4号炉	女川原子力発電所2号炉	泊発電所3号炉	相違理由																								
	<p>表17 ベースプレートとアンカーボルトの許容荷重（せん断）比較</p> <table border="1" data-bbox="719 172 1299 288"> <thead> <tr> <th></th> <th>仕様</th> <th>許容荷重（せん断）</th> <th>（許容値）</th> </tr> </thead> <tbody> <tr> <td>④アンカーボルト</td> <td>D25（ねじ部 M24）× 16本 SD390</td> <td>102kN*</td> <td>226MPa</td> </tr> <tr> <td>⑧ベースプレート</td> <td>t40×1160×1050 SM490A</td> <td>1584kN</td> <td>198MPa</td> </tr> </tbody> </table> <p>※ベースプレートとの許容荷重比較のため、下図に示すボルト1本に対する許容荷重を算出</p> <div style="border: 2px solid black; height: 100px; width: 100%;"></div> <p>※ベースプレートとの許容荷重比較のため、下図に示すボルト1本に対する許容荷重を算出</p> <p>(3) 可動支承に対する評価部材の代表性検討 各部材の許容応力から算出される許容荷重を比較し、同様の荷重モードが負荷される部材については、許容荷重が小さい部材を代表として強度評価を実施することとする。</p> <p>a. エンドプレート 可動支承が上向き荷重を受ける場合、エンドプレートは主に曲げ荷重、エンドプレート接合ボルトは引張荷重を受け、許容荷重はエンドプレート接合ボルトの方が小さいため、エンドプレートの評価はエンドプレート接合ボルトで代表する。なお、設計上、エンドプレートよりもエンドプレート接合ボルトが弱部になるように設計をしている。</p> <p>表18 エンドプレートとエンドプレート接合ボルト（評価対象部品）の許容荷重</p> <table border="1" data-bbox="734 1066 1310 1177"> <thead> <tr> <th></th> <th>仕様</th> <th>許容荷重</th> <th>（許容値）</th> </tr> </thead> <tbody> <tr> <td>⑨エンドプレート接合ボルト</td> <td>M27×6本 強度区分 8.8以上</td> <td>240 kN（引張）*</td> <td>420MPa</td> </tr> <tr> <td>⑩エンドプレート</td> <td>t36×φ305 SS400</td> <td>247 kN（曲げ）</td> <td>323MPa</td> </tr> </tbody> </table> <p>※下図に示すボルト1本に対する許容荷重を算出</p> <div data-bbox="725 1225 1124 1404"> </div>		仕様	許容荷重（せん断）	（許容値）	④アンカーボルト	D25（ねじ部 M24）× 16本 SD390	102kN*	226MPa	⑧ベースプレート	t40×1160×1050 SM490A	1584kN	198MPa		仕様	許容荷重	（許容値）	⑨エンドプレート接合ボルト	M27×6本 強度区分 8.8以上	240 kN（引張）*	420MPa	⑩エンドプレート	t36×φ305 SS400	247 kN（曲げ）	323MPa		
	仕様	許容荷重（せん断）	（許容値）																								
④アンカーボルト	D25（ねじ部 M24）× 16本 SD390	102kN*	226MPa																								
⑧ベースプレート	t40×1160×1050 SM490A	1584kN	198MPa																								
	仕様	許容荷重	（許容値）																								
⑨エンドプレート接合ボルト	M27×6本 強度区分 8.8以上	240 kN（引張）*	420MPa																								
⑩エンドプレート	t36×φ305 SS400	247 kN（曲げ）	323MPa																								

赤字：設備、運用又は体制の相違（設計方針の相違）
 青字：記載箇所又は記載内容の相違（記載方針の相違）
 緑字：記載表現、設備名称の相違（実質的な相違なし）

大飯発電所3/4号炉	女川原子力発電所2号炉	泊発電所3号炉	相違理由
	<p style="text-align: right;">別紙 3</p> <p>竜巻防護ネットの構造成立性確認結果について（STEP1） （ゴム支承の剛性を耐震評価時に用いるせん断剛性とする場合）</p> <p>1. 解析条件</p> <p>ゴム支承に支持されるフレームに飛来物が衝突した際の挙動を確認するため、図1に示すフローのとおり、ゴム支承の剛性を考慮した衝突解析を実施する。</p> <p>衝突解析は、ゴム支承による影響が最も大きくなると想定される条件（飛来物姿勢、衝突位置、飛来方向）で実施し、ゴム支承の影響を考慮した場合において、フレームゴム支承、可動支承がフレームを支持する機能を維持可能な構造強度を有することを確認する。</p> <p>評価対象は支持機能に大きな影響を与える部材であるフレームゴム支承と可動支承とする。解析条件とその考え方を表1、2及び図2に示す。</p> <div style="border: 1px solid black; padding: 10px; margin: 10px 0;"> <p style="text-align: center;">STEP1</p> <pre> graph TD A[飛来物のフレームへの衝突] --> B[ゴム支承の剛性を考慮*1してモデル化し、LS-DYNAにより衝突解析を実施] B --> C[フレームゴム支承] B --> D[可動支承] C --> E[応力評価*2] D --> F[応力評価*2] E --> G[END] F --> H[END] </pre> <p>*1: 耐震評価で用いるせん断剛性 *2: LS-DYNAによる衝突解析により支承部のピーク反力を算出し評価を実施</p> </div> <p style="text-align: center;">図1 STEP1 構造成立性確認フロー</p>		<p>【女川】</p> <ul style="list-style-type: none"> ・竜巻防護設備の構造の相違による資料の作成要否の相違。 ・女川は竜巻防護ネットを設置する海水ポンプエリアの壁が薄く支持機能に期待できないため、可動支承、ゴム支承を採用して地震により生じる応力を低減・分散させる構造として、ネットの支持機能を確保している。 ・泊においては、女川と異なり竜巻防護ネットは強固な建屋床面、ブラケットを介してピット壁面に設置できる環境であることから、女川で採用している可動式の機構を持たせる必要はない。 ・以上の理由から、泊の竜巻防護ネットは、先行プラント（大飯、高浜）と同様の竜巻防護ネットの構造を採用しており、架構に直接、竜巻防護ネットを設置する構造としている。 ・本資料は、ゴム支承及び可動支承を採用したことによる設計成立性に関する説明資料である。 ・泊では、ゴム支承等は使用していないことから、本資料は不要と判断し、作成していない。 <p>（竜巻防護ネットの強度計算結果は設工認で説明する方針）</p>

赤字：設備、運用又は体制の相違（設計方針の相違）
 青字：記載箇所又は記載内容の相違（記載方針の相違）
 緑字：記載表現、設備名称の相違（実質的な相違なし）

大飯発電所3/4号炉	女川原子力発電所2号炉	泊発電所3号炉	相違理由																											
<div style="display: flex; justify-content: space-between;"> <div style="width: 30%;"> <p style="text-align: center;">表1 STEP1の解析条件</p> <table border="1" style="width: 100%; border-collapse: collapse;"> <thead> <tr> <th style="width: 15%;">設定項目</th> <th style="width: 15%;">設定条件</th> <th style="width: 70%;">考え方</th> </tr> </thead> <tbody> <tr> <td>ゴム支承の剛性</td> <td>耐震評価で用いるせん断剛性（表2参照）</td> <td>設計飛来物がフレームに衝突した場合に想定されるゴム支承の変位速度は、約0.1m/sと考えられる（別紙3（補足1）参照）。この変位速度は、地震時のゴム支承の動的特性を把握するために実施した振動数依存性試験におけるゴム支承の変位速度（0.06～0.6m/s）に包絡されることから、飛来物衝突においても、耐震評価で用いるゴム支承のせん断剛性を適用する。</td> </tr> <tr> <td>衝突方向</td> <td>水平方向</td> <td>配置及び形状から水平方向から衝突する可能性は極めて低いと考えられるが、鉛直速度よりも最大速度が大きく、ゴム支承のせん断剛性への影響が大きい方向。</td> </tr> <tr> <td>衝突位置</td> <td>ゴム支承近傍</td> <td>ゴム支承への影響が大きくなると考えられる位置。</td> </tr> <tr> <td>飛来物姿勢</td> <td>長辺全面で衝突</td> <td>フレームには防護板や補強用のリブが設置されることから、平面となる面積が限られており、長辺全面が部材に垂直に衝突する可能性は極めて低いと考えられるが、最もゴム支承に対し厳しい姿勢による挙動を確認する観点から、長辺全面が衝突すると設定。</td> </tr> </tbody> </table> <p style="text-align: center;">表2 フレームゴム支承、可動支承の結合条件</p> <table border="1" style="width: 100%; border-collapse: collapse; text-align: center;"> <thead> <tr> <th style="width: 15%;">方向</th> <th style="width: 35%;">フレームゴム支承</th> <th style="width: 50%;">可動支承</th> </tr> </thead> <tbody> <tr> <td>X</td> <td>弾性</td> <td>自由</td> </tr> <tr> <td>Y</td> <td>弾性</td> <td>剛</td> </tr> <tr> <td>Z</td> <td>剛</td> <td>剛</td> </tr> </tbody> </table> <div style="text-align: center;"> <p>図2 飛来物衝突位置及び解析モデル図（STEP1）</p> </div> </div> <div style="width: 65%;"> <p>2. 解析結果</p> <p>フレームゴム支承の衝突解析結果を表3、可動支承の衝突解析結果を表4に示す。</p> <p>フレームゴム支承の評価対象部材に発生する応力等は許容値を超えず、「4.1.2 支持部材（4）」に定める構造強度上の評価方針を満足する。</p> <p>可動支承については、評価対象部材のうち、「レール」「レール取付ボルト」「エンドプレート接合ボルト」について許容値を超える結果となった。</p> <p>STEP1の評価結果から、フレームゴム支承の剛性を考慮した場合において、フレームゴム支承による影響が最も大きくなると想定される個所に飛来物が衝突した場合でもフレームゴム支承は構造強度上の評価方針を満足し、フレームを支持する機能を維持可能な構造強度を有することを確認した。可動支承については一部部材が許容値を超える結果となったが、詳細設計段階では、可動支承のサイズアップやボルトの仕様変更等の対応を行うことで、許容値を満足させる方針とする。</p> </div> </div>				設定項目	設定条件	考え方	ゴム支承の剛性	耐震評価で用いるせん断剛性（表2参照）	設計飛来物がフレームに衝突した場合に想定されるゴム支承の変位速度は、約0.1m/sと考えられる（別紙3（補足1）参照）。この変位速度は、地震時のゴム支承の動的特性を把握するために実施した振動数依存性試験におけるゴム支承の変位速度（0.06～0.6m/s）に包絡されることから、飛来物衝突においても、耐震評価で用いるゴム支承のせん断剛性を適用する。	衝突方向	水平方向	配置及び形状から水平方向から衝突する可能性は極めて低いと考えられるが、鉛直速度よりも最大速度が大きく、ゴム支承のせん断剛性への影響が大きい方向。	衝突位置	ゴム支承近傍	ゴム支承への影響が大きくなると考えられる位置。	飛来物姿勢	長辺全面で衝突	フレームには防護板や補強用のリブが設置されることから、平面となる面積が限られており、長辺全面が部材に垂直に衝突する可能性は極めて低いと考えられるが、最もゴム支承に対し厳しい姿勢による挙動を確認する観点から、長辺全面が衝突すると設定。	方向	フレームゴム支承	可動支承	X	弾性	自由	Y	弾性	剛	Z	剛	剛
設定項目	設定条件	考え方																												
ゴム支承の剛性	耐震評価で用いるせん断剛性（表2参照）	設計飛来物がフレームに衝突した場合に想定されるゴム支承の変位速度は、約0.1m/sと考えられる（別紙3（補足1）参照）。この変位速度は、地震時のゴム支承の動的特性を把握するために実施した振動数依存性試験におけるゴム支承の変位速度（0.06～0.6m/s）に包絡されることから、飛来物衝突においても、耐震評価で用いるゴム支承のせん断剛性を適用する。																												
衝突方向	水平方向	配置及び形状から水平方向から衝突する可能性は極めて低いと考えられるが、鉛直速度よりも最大速度が大きく、ゴム支承のせん断剛性への影響が大きい方向。																												
衝突位置	ゴム支承近傍	ゴム支承への影響が大きくなると考えられる位置。																												
飛来物姿勢	長辺全面で衝突	フレームには防護板や補強用のリブが設置されることから、平面となる面積が限られており、長辺全面が部材に垂直に衝突する可能性は極めて低いと考えられるが、最もゴム支承に対し厳しい姿勢による挙動を確認する観点から、長辺全面が衝突すると設定。																												
方向	フレームゴム支承	可動支承																												
X	弾性	自由																												
Y	弾性	剛																												
Z	剛	剛																												

赤字：設備、運用又は体制の相違（設計方針の相違）
 青字：記載箇所又は記載内容の相違（記載方針の相違）
 緑字：記載表現、設備名称の相違（実質的な相違なし）

大飯発電所3/4号炉

女川原子力発電所2号炉

泊発電所3号炉

相違理由

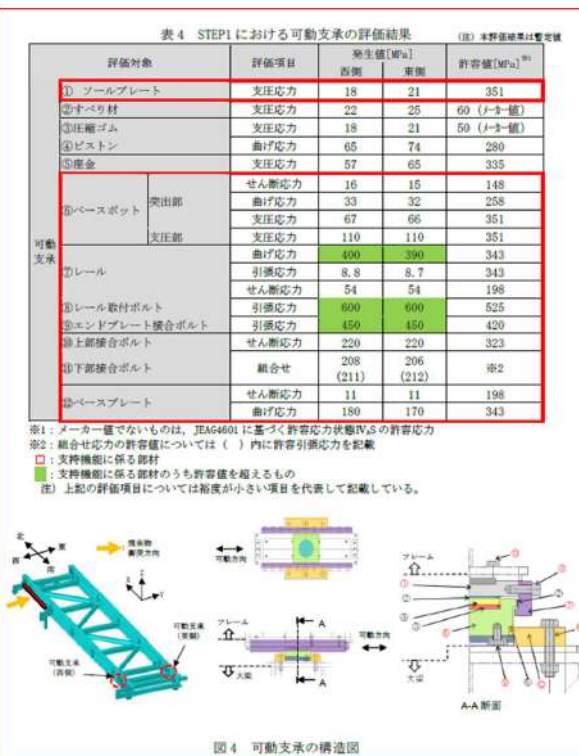
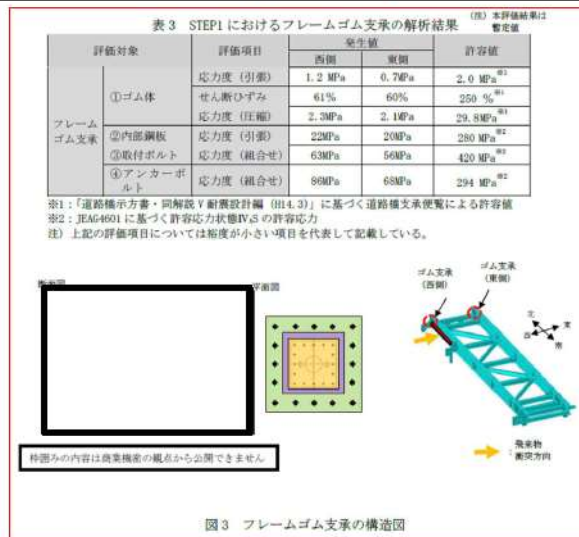

赤字：設備、運用又は体制の相違（設計方針の相違）
 青字：記載箇所又は記載内容の相違（記載方針の相違）
 緑字：記載表現、設備名称の相違（実質的な相違なし）

泊発電所3号炉 D B基準適合性 比較表

第6条 外部からの衝撃による損傷の防止（竜巻：別添資料1 添付資料3.13）

大飯発電所3/4号炉	女川原子力発電所2号炉	泊発電所3号炉	相違理由
	<p style="text-align: center;">別紙3（補足1）</p> <p style="text-align: center;">衝突解析に対するゴム支承の影響に対する検討</p> <p>竜巻防護ネットに採用する地震時水平力分散型ゴム支承は、ゴム支承のせん断剛性を利用して、上部構造の慣性力を複数の下部構造に分散させる機能を持つ。耐震設計については「道路橋示方書・同解説（（社）日本道路協会、平成14年3月）」及び「道路橋支承便覧（（社）日本道路協会、平成16年4月）」に則り、線形ばね要素でモデル化し、ゴム支承による荷重の低減効果を見込んだ耐震評価を実施する。（竜巻防護ネットの耐震評価方針については、設置許可基準規則第4条に対する適合状況説明資料『設計基準対象施設について（第4条 地震による損傷の防止）』で説明）</p> <p>一方、飛来物の衝撃荷重によるゴム支承の影響・評価については、先行プラントにおいて審査実績がないことや、評価に関わる規格類が制定されていないことを踏まえ、衝突解析におけるゴム支承の影響について、以下のとおり検討を実施した。</p> <p>1. 飛来物衝突時と地震時におけるゴム支承変位速度の比較</p> <p>(1) 検討方法</p> <p>竜巻防護ネットのフレームはゴム支承に支持されているため、飛来物が衝突した場合や地震時にはフレームが移動する。フレームの移動速度が飛来物衝突時と地震時で異なる場合、ゴム支承の挙動が異なることが考えられる。</p> <p>この影響を検討するため、飛来物衝突後のフレーム移動速度から想定されるゴム支承の変位速度と、耐震評価において想定するゴム支承の変位速度を比較し検討する。</p> <p>(2) 飛来物衝突時のフレーム速度の算出</p> <p>竜巻防護ネットのフレームに飛来物が衝突した際のフレームの移動速度は、衝突前後の運動量保存則から算出する。算出にあたって、ゴム支承のばね剛性はフレームの移動に対し抵抗となり得るが、この影響はないものとして扱う。飛来物はフレームの南側に衝突し、衝突後はフレームと飛来物が一体となって移動を始めるものとする。（図1参照）</p> <p>以上の条件から、運動量保存則から以下の式が成り立つ</p> <div style="border: 1px solid black; padding: 5px; margin-top: 10px;"> $m v = (m+M) V \dots \textcircled{1}$ <p>ここで、m：設計飛来物（鋼製材）重量（$m=135\text{kg}$） v：設計飛来物（鋼製材）衝突速度（$v=46.6\text{m/s}$） M：フレーム重量（$M=62000\text{kg}$） V：衝突後のフレーム移動速度（m/s）</p> </div>		<p>【女川】</p> <ul style="list-style-type: none"> ・竜巻防護設備の構造の相違による資料の作成要否の相違。 ・女川は竜巻防護ネットを設置する海水ポンプエリアの壁が薄く支持機能に期待できないため、可動支承、ゴム支承を採用して地震により生じる応力を低減・分散させる構造として、ネットの支持機能を確保している。 ・泊においては、女川と異なり竜巻防護ネットは強固な建屋床面、ブラケットを介してピット壁面に設置できる環境であることから、女川で採用している可動式の機構を持たせる必要はない。 ・以上の理由から、泊の竜巻防護ネットは、先行プラント（大飯、高浜）と同様の竜巻防護ネットの構造を採用しており、架構に直接、竜巻防護ネットを設置する構造としている。 ・本資料は、ゴム支承及び可動支承を採用したことによる設計成立性に関する説明資料である。 ・泊では、ゴム支承等は使用していないことから、本資料は不要と判断し、作成していない。 （竜巻防護ネットの強度計算結果は設工認で説明する方針）

赤字：設備、運用又は体制の相違（設計方針の相違）
 青字：記載箇所又は記載内容の相違（記載方針の相違）
 緑字：記載表現、設備名称の相違（実質的な相違なし）

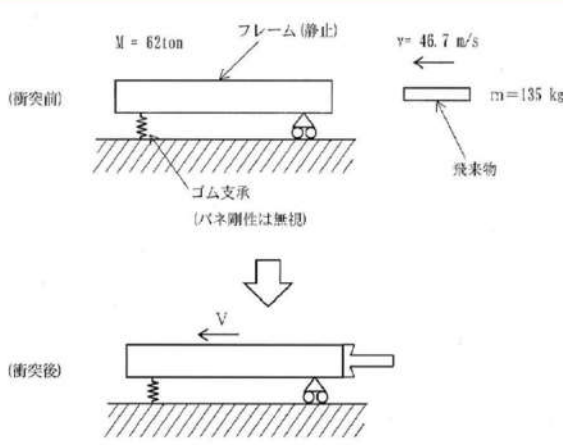
大飯発電所3/4号炉	女川原子力発電所2号炉	泊発電所3号炉	相違理由
	 <p>図1 飛来物衝突前後のイメージ</p> <p>①式より、</p> $V = m v / (m + M)$ $= 135 \times 46.6 / (135 + 62000)$ $\approx 0.1 \text{ (m/s)}$ <p>上記のとおり、フレームの質量が飛来物に比べて著しく大きいことから、衝突後のフレームの移動速度は最大でも約0.1m/sとなる。フレームはゴム支承に支持されていることから、ゴム支承の変位速度はフレームの移動速度と同等の速度になると想定される。</p> <p>(3) ゴム支承特性試験について</p> <p>ゴム支承の動的特性を把握するための試験のうち振動数依存性試験を実施している。本試験は、ゴム支承を振幅95mmの単振動（0.1～1Hzの振動数）でせん断変形させた際の剛性を実測したものである。試験結果を図2に示す。（図2は「設置許可基準規則第4条に対する適合状況説明資料『設計基準対象施設について（第4条 地震による損傷の防止）』より抜粋）</p> <p>ここで、変位 $x = A \sin \omega t$ より（$A = 95 \text{ mm}$, $\omega = 2\pi f$, $f = 0.1, 0.5, 1.0 \text{ Hz}$）</p> <p>変位速度 $\dot{x} = A \omega \cos \omega t$ であるから、変位速度の最大値は $A \omega$ となる。</p> <p>$f = 0.1 \text{ Hz}$ のとき、$A \omega = 95 \times 2\pi \times 0.1 \approx 0.06 \text{ m/s}$</p> <p>$f = 1.0 \text{ Hz}$ のとき、$A \omega = 95 \times 2\pi \times 1.0 \approx 0.60 \text{ m/s}$</p>		

赤字：設備、運用又は体制の相違（設計方針の相違）
 青字：記載箇所又は記載内容の相違（記載方針の相違）
 緑字：記載表現、設備名称の相違（実質的な相違なし）

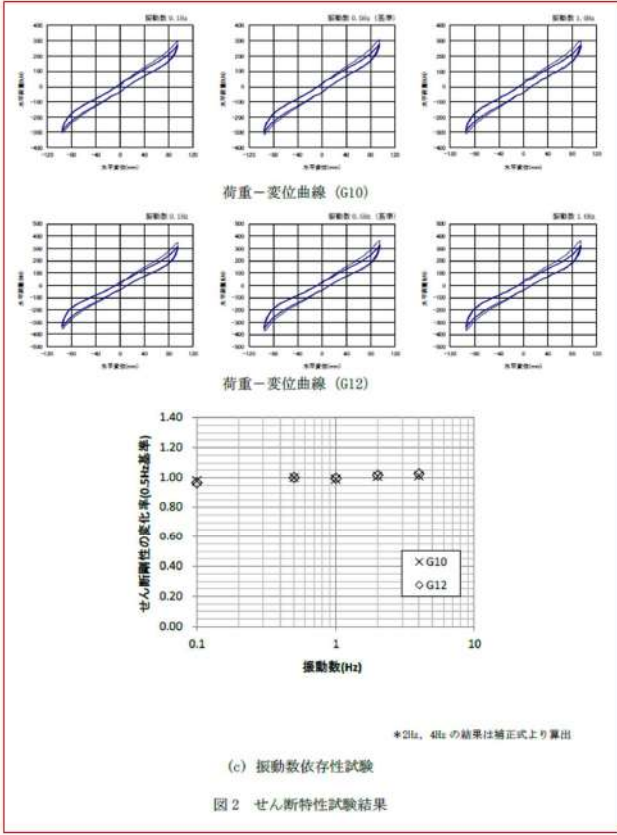
大飯発電所3/4号炉	女川原子力発電所2号炉	泊発電所3号炉	相違理由
	<p>よって振動数依存性試験における変位速度の最大値は約0.06～0.60m/sの範囲となる。試験結果から、この速度範囲において、せん断剛性の変化は無視できるものであることを確認している</p>  <p>(c) 振動数依存性試験 図2 せん断特性試験結果</p>		